

# HP LaserJet M2727 MFP Series

## Service Manual

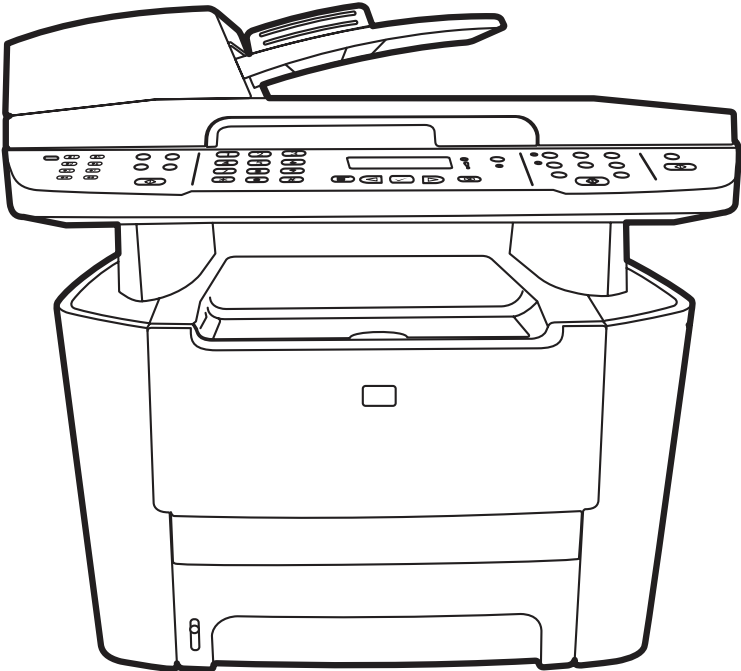



# HP LaserJet M2727 MFP Series Service Manual



## Copyright information

© 2007 Copyright Hewlett-Packard Development Company, L.P.

Reproduction, adaptation, or translation without prior written permission is prohibited, except as allowed under the copyright laws.

The information contained herein is subject to change without notice.

The only warranties for HP products and services are set forth in the express warranty statements accompanying such products and services. Nothing herein should be construed as constituting an additional warranty. HP shall not be liable for technical or editorial errors or omissions contained herein.

Part number CB532-90946

Edition 1, 11/2007

## Safety information

**WARNING!**

Potential Shock Hazard

Always follow basic safety precautions when using the product to reduce risk of injury from fire or electric shock.

Read and understand all instructions in the user guide.

Observe all warnings and instructions marked on the product.

Use only a grounded electrical outlet when connecting the product to a power source. If you do not know whether the outlet is grounded, check with a qualified electrician.

Do not touch the contacts on the end of any of the sockets on the product. Replace damaged cords immediately.

Unplug the product from wall outlets before cleaning.

Do not install or use the product near water or when you are wet.

Install the product securely on a stable surface.

Install the product in a protected location where no one can step on or trip over the power cord and where the power cord will not be damaged.

If the product does not operate normally, see the online user guide.

Refer all servicing questions to qualified personnel.

Information regarding FCC Class B, Parts 15 and 68 requirements can be found in the user guide.

## Trademark credits

Microsoft® and Windows® are U.S. registered trademarks of Microsoft Corporation.

Windows Vista™ is either a registered trademark or trademark of Microsoft Corporation in the United States and/or other countries.

Linux is a U.S. registered trademark of Linus Torvalds.

UNIX® is a registered trademark of The Open Group.

PostScript® is a trademark of Adobe Systems Incorporated.

Energy Star® and the Energy Star logo® are U.S. registered marks of the United States Environmental Protection Agency.





---

# Table of contents

## 1 Product information

|   |    |
|---|----|
| Quick access to product information .....                           | 2  |
| Product comparison .....  | 3  |
| Product features .....  | 4  |
| Product walkaround .....  | 5  |
| Front view .....  | 5  |
| Back view .....   | 6  |
| Interface ports .....   | 6  |
| Control panel .....   | 7  |
| Serial number and model number location .....                       | 8  |
| Software description .....  | 9  |
| Supported operating systems .....                                   | 9  |
| Supported printer drivers .....                                     | 9  |
| Software included with the product .....                            | 9  |
| Recommended installation for Windows .....                          | 10 |
| Express installation (USB or network) .....                         | 10 |
| Macintosh software .....  | 10 |
| Software for Windows .....  | 12 |
| HP ToolboxFX .....  | 12 |
| Embedded Web server (EWS) .....                                     | 12 |
| Software for Macintosh .....  | 13 |
| HP Director .....   | 13 |
| Macintosh Configure Device (Mac OS X v10.3, v10.4, and later) ..... | 13 |
| PDEs (Mac OS X v10.3, v10.4, and later) .....                       | 14 |
| Uninstall software .....  | 15 |
| Windows .....   | 15 |
| Macintosh .....   | 15 |
| Media specifications .....  | 16 |
| Supported paper and print media sizes .....                         | 16 |
| Media to avoid .....  | 17 |
| Media that can damage the product .....                             | 17 |

## 2 Installation

|                                     |    |
|-------------------------------------|----|
| Operating environment .....         | 20 |
| Minimum system requirements .....   | 21 |
| Unpack the product .....            | 22 |
| Install input devices .....         | 23 |
| ADF input tray .....                | 23 |
| 250-sheet input tray (tray 3) ..... | 24 |

|  |    |
|--|----|
| Install the control-panel faceplate .....  | 25 |
| Load paper and print media .....           | 26 |
| Load documents to fax, copy, or scan ..... | 26 |
| Tray 1 .....                               | 27 |
| Tray 2 or 3 .....                          | 28 |
| Configure trays .....                      | 29 |
| Change tray selection .....                | 29 |
| Install memory DIMMs .....                 | 30 |
| Information .....                          | 30 |
| Install a memory DIMM .....                | 30 |

### 3 Maintenance

|   |    |
|---|----|
| Manage supplies .....                                       | 34 |
| Life expectancies of supplies and the product .....         | 34 |
| Order supplies .....  | 34 |
| Store print cartridges .....                                | 35 |
| Replace and recycle supplies .....                          | 35 |
| Replace print cartridge .....                               | 37 |
| Load staples .....  | 39 |
| Replace the tray 2 pickup roller .....                      | 40 |
| Replace the tray 2 and optional tray 3 separation pad ..... | 45 |
| HP policy on non-HP supplies .....                          | 48 |
| Reset the product for non-HP supplies .....                 | 48 |
| HP fraud hotline .....                                      | 48 |
| Clean the product .....                                     | 49 |
| Clean the exterior .....                                    | 49 |
| Clean the flatbed scanner glass .....                       | 49 |
| Clean the scanner-cover backing .....                       | 51 |
| Clean the tray 2 pickup roller .....                        | 52 |
| Clean the ADF pickup-roller assembly .....                  | 55 |
| Clean the paper path .....                                  | 56 |
| Clean the paper path from HP ToolboxFX .....                | 57 |
| Clean the paper path from the product control panel .....   | 57 |
| Manage the product .....                                    | 58 |
| HP ToolboxFX .....  | 58 |
| View the HP ToolboxFX .....                                 | 58 |
| Status .....  | 58 |
| Event log .....   | 59 |
| Alerts .....  | 59 |
| Set up status alerts .....                                  | 59 |
| Set up e-mail alerts .....                                  | 59 |
| Fax .....   | 59 |
| Fax tasks .....   | 60 |
| Fax phone book .....  | 60 |
| Fax send log .....  | 62 |
| Fax receive log .....                                       | 62 |
| Help (Documentation) .....                                  | 62 |
| System settings .....                                       | 63 |
| Device information .....                                    | 63 |
| Paper handling .....  | 64 |

|   |    |
|---|----|
| Print quality .....   | 64 |
| Paper types .....   | 64 |
| System setup .....  | 65 |
| Service .....   | 65 |
| Device Polling .....  | 65 |
| Print settings .....  | 65 |
| Printing .....  | 65 |
| PCL 5e .....  | 66 |
| PostScript .....  | 66 |
| Network settings .....  | 66 |
| Embedded Web server .....   | 66 |
| Features .....  | 66 |
| Secure the embedded Web server .....                                | 67 |
| Macintosh Configure Device (Mac OS X v10.3, v10.4, and later) ..... | 67 |

#### 4 Theory of operation

|   |    |
|---|----|
| Basic operation .....                         | 70 |
| Sequence of operation for the base unit ..... | 70 |
| Scanner and ADF functions and operation ..... | 72 |
| Scanner functions .....                       | 72 |
| Scanner operation .....                       | 73 |
| ADF operation .....                           | 73 |
| ADF paper path and ADF sensors .....          | 74 |
| ADF jam detection .....                       | 75 |
| Internal components (base unit) .....         | 76 |
| Engine control system .....                   | 78 |
| Laser/scanner system .....                    | 80 |
| Pickup/feed/delivery system .....             | 81 |
| Image-formation system .....                  | 83 |
| Fax functions and operation .....             | 87 |
| Computer and network security features .....  | 87 |
| PSTN operation .....                          | 87 |
| Receive faxes when you hear fax tones .....   | 87 |
| Distinctive ring function .....               | 88 |
| Fax by using Voice over IP services .....     | 88 |
| The fax subsystem .....                       | 89 |
| Fax card in the fax subsystem .....           | 89 |
| Safety isolation .....                        | 89 |
| Safety-protection circuitry .....             | 89 |
| Data path .....                               | 90 |
| Hook state .....                              | 90 |
| Downstream device detection .....             | 90 |
| Hook switch control .....                     | 90 |
| Ring detect .....                             | 91 |
| Line current control .....                    | 91 |
| Billing- (metering-) tone filters .....       | 91 |
| Fax page storage in flash memory .....        | 91 |
| Stored fax pages .....                        | 91 |
| Advantages of flash memory storage .....      | 91 |

## 5 Removal and replacement

|  |     |
|--|-----|
| Introduction .....   | 94  |
| Removal and replacement strategy .....   | 94  |
| Electrostatic discharge .....  | 94  |
| User-replaceable parts .....   | 94  |
| Required tools .....   | 95  |
| Before performing service .....  | 95  |
| After performing service .....   | 96  |
| Post-service tests .....   | 96  |
| Test 1 (print-quality test) .....  | 96  |
| Test 2 (copy-quality test) .....   | 96  |
| Test 3 (fax-quality test) .....  | 97  |
| Parts removal order .....  | 98  |
| Remove the print cartridge .....   | 99  |
| External panels, covers, and doors .....   | 100 |
| Right cover .....  | 100 |
| Left cover .....   | 102 |
| Print-cartridge door .....   | 104 |
| Rear cover .....   | 106 |
| Top cover .....  | 108 |
| Replace the ADF pickup-roller assembly .....   | 110 |
| ADF scanner glass .....  | 113 |
| ADF assembly .....   | 115 |
| Scanner/ADF assembly .....   | 117 |
| Bezel and control panel .....  | 119 |
| Internal assemblies .....  | 122 |
| Convenience-stapler assembly (HP LaserJet M2727nfs only) .....                       | 122 |
| Convenience-stapler power supply (HP LaserJet M2727nfs only) .....                   | 124 |
| Convenience-stapler AC inlet cable (HP LaserJet M2727nfs only) .....                 | 126 |
| Convenience-stapler power supply bracket and strap (HP LaserJet M2727nfs only) ..... | 127 |
| Speaker .....  | 128 |
| Power-switch PCA .....   | 130 |
| Formatter .....  | 132 |
| Duplex assembly .....  | 135 |
| Laser/scanner (print engine) .....   | 137 |
| Memory-tag-reader assembly (E-label reader) .....                                    | 139 |
| Fan .....  | 141 |
| Duplex-drive gears .....   | 143 |
| Duplex solenoid .....  | 145 |
| Fuser .....  | 147 |
| Interlock assembly .....   | 152 |
| Engine controller assembly (ECU) .....   | 153 |
| Main motor .....   | 158 |
| Pickup-and-feed assemblies .....   | 160 |
| Transfer roller .....  | 160 |
| Registration-roller assembly .....   | 161 |
| Main gear assembly and tray 2 pickup solenoid .....                                  | 162 |

## 6 Solve problems

|                                 |     |
|---------------------------------|-----|
| Problem-solving checklist ..... | 166 |
|---------------------------------|-----|

|   |     |
|---|-----|
| Control-panel messages .....  | 169 |
| Alert and warning messages .....  | 169 |
| Alert and warning message tables .....  | 169 |
| Critical error messages .....   | 177 |
| Critical error message-tables .....   | 177 |
| Clear jams .....  | 179 |
| Causes of jams .....  | 179 |
| Where to look for jams .....  | 180 |
| Clear jams from the ADF .....   | 180 |
| Clear jams from the input-tray areas .....                                    | 182 |
| Clear jams from the duplexer .....  | 184 |
| Clear jams from the output-bin areas .....                                    | 186 |
| Top (face-down) output bin .....  | 186 |
| Rear (face-up) output bin .....   | 187 |
| Clear jams from the print-cartridge area .....                                | 188 |
| Clear jams from the convenience stapler (HP LaserJet M2727nfs MFP only) ..... | 189 |
| Avoid repeated jams .....   | 190 |
| Control-panel menus .....   | 191 |
| Use the control-panel main menus .....  | 191 |
| Control-panel main menus .....  | 191 |
| Control-panel secondary menus .....   | 199 |
| Use the control-panel secondary menus .....                                   | 199 |
| Control-panel secondary menus .....   | 199 |
| Print problems .....  | 204 |
| Print-quality problems .....  | 204 |
| Improve print quality .....   | 204 |
| Print-quality settings .....  | 204 |
| Identify and correct print defects .....                                      | 205 |
| Print-quality checklist .....   | 205 |
| General print-quality issues .....  | 205 |
| Scan problems .....   | 211 |
| Solve scanned-image problems .....  | 211 |
| Scan-quality problems .....   | 213 |
| Prevent problems .....  | 213 |
| Solve scan-quality problems .....   | 213 |
| Copy problems .....   | 214 |
| Prevent problems .....  | 214 |
| Image problems .....  | 214 |
| Media-handling problems .....   | 215 |
| Performance problems .....  | 217 |
| Fax problems .....  | 218 |
| General fax problem-solve .....   | 218 |
| Problems receiving faxes .....  | 219 |
| Problems sending faxes .....  | 222 |
| Voice-call problems .....   | 224 |
| Media-handling problems .....   | 225 |
| Performance problems .....  | 226 |
| Control-panel display problems .....  | 227 |
| Convenience-stapler problems (HP LaserJet M2727nfs only) .....                | 227 |
| DSL problems .....  | 228 |

|  |     |
|--|-----|
| PABX line problems .....                               | 228 |
| ADF problems .....                                     | 229 |
| Functional checks .....                                | 230 |
| Drum rotation test .....                               | 230 |
| Engine test .....                                      | 231 |
| Half self-test functional check .....                  | 232 |
| Perform a half self-test check .....                   | 232 |
| Perform other checks .....                             | 232 |
| Heating element check .....                            | 233 |
| High-voltage contacts check .....                      | 233 |
| Check the print-cartridge contacts .....               | 233 |
| Check the high-voltage connector assembly .....        | 234 |
| Service-mode functions .....                           | 235 |
| NVRAM initialization .....                             | 235 |
| Super NVRAM initialization .....                       | 235 |
| Service menu .....                                     | 235 |
| Problem-solve tools .....                              | 237 |
| Product information pages and reports .....            | 237 |
| Configuration page .....                               | 237 |
| Supplies Status page .....                             | 237 |
| PCL, PCL 6, or PS font list .....                      | 237 |
| Demo page .....  | 238 |
| Usage page .....                                       | 238 |
| Menu map .....   | 238 |
| Network report .....                                   | 238 |
| Fax reports .....                                      | 239 |
| Fax activity log .....                                 | 239 |
| Fax call report .....                                  | 239 |
| Phone book report .....                                | 239 |
| Billing-code report .....                              | 240 |
| HP ToolboxFX .....                                     | 240 |
| To view HP ToolboxFX .....                             | 240 |
| Troubleshooting tab .....                              | 240 |
| Service menu .....                                     | 241 |
| Restore the factory-set defaults .....                 | 241 |
| Clean the paper path .....                             | 241 |
| T.30 protocol trace .....                              | 242 |
| Archive print .....                                    | 242 |
| Firmware updates .....                                 | 243 |
| Firmware update by using a flash executable file ..... | 243 |

## 7 Parts

|  |     |
|--|-----|
| Accessories and ordering information ..... | 247 |
| Supplies .....                             | 248 |
| Memory .....                               | 248 |
| Cable and interface accessories .....      | 248 |
| Paper-handling accessories .....           | 249 |
| Whole unit replacement .....               | 250 |
| Scanner/ADF replacement parts .....        | 254 |
| Control-panel bezels .....                 | 255 |

|  |     |
|--|-----|
| Supplementary documentation and support .....                    | 257 |
| Problem-solve diagrams .....                                     | 259 |
| Repetitive image defects .....                                   | 259 |
| Interface connectors .....                                       | 260 |
| Formatter connectors .....                                       | 260 |
| Fax card .....   | 261 |
| Solenoids .....  | 262 |
| Switches and sensors .....                                       | 263 |
| Rollers and pads .....   | 264 |
| PCAs (base unit) .....   | 265 |
| Major components (base unit) .....                               | 266 |
| Scanner and ADF .....  | 267 |
| Circuit diagram (1 of 2) .....                                   | 268 |
| Circuit diagram (2 of 2) .....                                   | 268 |
| Parts lists and diagrams .....                                   | 270 |
| Types of screws .....  | 271 |
| Scanner and ADF assemblies .....                                 | 272 |
| Scanner components .....   | 274 |
| ADF components .....   | 276 |
| Convenience stapler components (HP LaserJet M2727nfs only) ..... | 278 |
| Formatter, fax card, HP jewel, and nameplate .....               | 280 |
| External covers and panels .....                                 | 282 |
| Cartridge door assembly .....                                    | 284 |
| Internal components (1 of 4) .....                               | 286 |
| Internal components (2 of 4) .....                               | 288 |
| Internal components (3 of 4) .....                               | 290 |
| Internal components (4 of 4) .....                               | 292 |
| Engine-controller assembly (ECU) .....                           | 294 |
| Main-drive assembly .....  | 296 |
| Duplexing-drive assembly .....                                   | 298 |
| Tray 2 cassette and tray 3 cassette/feeder .....                 | 300 |
| Duplexing assembly .....   | 302 |
| Fuser assembly .....   | 304 |
| Alphabetical parts list .....                                    | 306 |
| Numerical parts list .....                                       | 312 |

## Appendix A Service and support

|  |     |
|--|-----|
| Hewlett-Packard limited warranty statement ..... | 319 |
| Print cartridge limited warranty statement ..... | 321 |

## Appendix B Specifications

|                                    |     |
|------------------------------------|-----|
| Physical specifications .....      | 324 |
| Electrical specifications .....    | 324 |
| Power consumption .....            | 324 |
| Environmental specifications ..... | 325 |
| Acoustic emissions .....           | 325 |

## Appendix C Regulatory information

|                      |     |
|----------------------|-----|
| FCC compliance ..... | 328 |
|----------------------|-----|

|   |            |
|---|------------|
| Environmental product stewardship program .....                                       | 329        |
| Protecting the environment .....  | 329        |
| Ozone production .....  | 329        |
| Power consumption .....   | 329        |
| Toner consumption .....   | 329        |
| Paper use .....   | 329        |
| Plastics .....  | 329        |
| HP LaserJet print supplies .....  | 329        |
| Return and recycling instructions .....   | 330        |
| United States and Puerto Rico .....   | 330        |
| Multiple returns (two to eight cartridges) .....                                      | 330        |
| Single returns .....  | 330        |
| Shipping .....  | 330        |
| Non-US returns .....  | 330        |
| Paper .....   | 330        |
| Material restrictions .....   | 330        |
| Disposal of waste equipment by users in private households in the European Union .... | 331        |
| Material Safety Data Sheet (MSDS) .....   | 331        |
| For more information .....  | 332        |
| Telephone Consumer Protection Act (United States) .....                               | 333        |
| IC CS-03 requirements .....   | 333        |
| EU statement for telecom operation .....  | 334        |
| New Zealand telecom statements .....  | 334        |
| Declaration of conformity .....   | 335        |
| Safety statements .....   | 336        |
| Laser safety .....  | 336        |
| Canadian DOC regulations .....  | 336        |
| EMI statement (Korea) .....   | 336        |
| Laser statement for Finland .....   | 337        |
| Substances table (China) .....  | 338        |
| <b>Index .....</b>  | <b>339</b> |



---

# List of tables

|            |   |     |
|------------|---|-----|
| Table 1-1  | Product guides .....                                | 2   |
| Table 1-2  | Supported printer drivers .....                     | 9   |
| Table 1-3  | Supported paper and print media sizes .....         | 16  |
| Table 1-4  | Supported envelopes and postcards .....             | 17  |
| Table 1-5  | ADF .....   | 17  |
| Table 4-1  | Sequence of operation .....                         | 70  |
| Table 4-2  | Power-on sequence .....                             | 71  |
| Table 6-1  | Alert and warning messages .....                    | 169 |
| Table 6-2  | Alert and warning messages .....                    | 172 |
| Table 6-3  | Critical error messages .....                       | 177 |
| Table 6-4  | Fax Job status menu .....                           | 191 |
| Table 6-5  | Fax functions menu .....                            | 191 |
| Table 6-6  | Copy setup menu .....                               | 192 |
| Table 6-7  | Reports menu .....                                  | 193 |
| Table 6-8  | Fax setup menu .....                                | 194 |
| Table 6-9  | System setup menu .....                             | 197 |
| Table 6-10 | Service menu .....                                  | 199 |
| Table 6-11 | Secondary service menu .....                        | 200 |
| Table 6-12 | Developer's menu .....                              | 201 |
| Table 7-1  | Whole unit replacement, product bundle CB532A ..... | 250 |
| Table 7-2  | Whole unit replacement, product bundle CB533A ..... | 252 |
| Table 7-3  | Control-panel bezels .....                          | 255 |
| Table 7-4  | Service and training support .....                  | 257 |
| Table 7-5  | User guides .....                                   | 257 |
| Table 7-6  | Getting started guide .....                         | 258 |
| Table 7-7  | Technical support Web sites .....                   | 258 |
| Table 7-8  | Repetitive image defects .....                      | 259 |
| Table 7-9  | Interface connectors .....                          | 260 |
| Table 7-10 | Formatter connectors .....                          | 260 |
| Table 7-11 | Fax card .....                                      | 261 |
| Table 7-12 | Solenoids .....                                     | 262 |
| Table 7-13 | Switches and sensors .....                          | 263 |
| Table 7-14 | Rollers and pads .....                              | 264 |
| Table 7-15 | PCAs (base unit) .....                              | 265 |
| Table 7-16 | Major components (base unit) .....                  | 266 |
| Table 7-17 | Scanner and ADF .....                               | 267 |
| Table 7-18 | Scanner and ADF assemblies .....                    | 273 |
| Table 7-19 | Scanner components .....                            | 275 |
| Table 7-20 | ADF components .....                                | 277 |

|            |  |     |
|------------|--|-----|
| Table 7-21 | Convenience stapler components (HP LaserJet M2727nfs only) | 279 |
| Table 7-22 | Formatter, Fax card, HP jewel, and nameplate               | 281 |
| Table 7-23 | External covers and panels                                 | 283 |
| Table 7-24 | Cartridge door assembly                                    | 285 |
| Table 7-25 | Internal components (1 of 4)                               | 287 |
| Table 7-26 | Internal components (2 of 4)                               | 289 |
| Table 7-27 | Internal components (3 of 4)                               | 291 |
| Table 7-28 | Internal components (4 of 4)                               | 293 |
| Table 7-29 | Engine-controller assembly                                 | 295 |
| Table 7-30 | Main-drive assembly  | 297 |
| Table 7-31 | Duplexing-drive assembly                                   | 299 |
| Table 7-32 | Tray 2 cassette and tray 3 cassette/feeder                 | 301 |
| Table 7-33 | Duplexing assembly   | 303 |
| Table 7-34 | Fuser assembly   | 305 |
| Table 7-35 | Alphabetical parts list                                    | 306 |
| Table 7-36 | Numerical parts list                                       | 312 |
| Table B-1  | Physical specifications                                    | 324 |
| Table B-2  | Electrical specifications                                  | 324 |
| Table B-3  | Power consumption (average, in watts),                     | 324 |
| Table B-4  | Environmental specifications                               | 325 |
| Table B-5  | Acoustic emissions   | 325 |

---

# List of figures

|             |  |    |
|-------------|--|----|
| Figure 2-1  | Operating environment .....                                | 20 |
| Figure 2-2  | HP LaserJet M2727 MFP package contents .....               | 22 |
| Figure 2-3  | Install the ADF input tray .....                           | 23 |
| Figure 2-4  | Install the 250-sheet input tray .....                     | 24 |
| Figure 2-5  | Install the control-panel faceplate .....                  | 25 |
| Figure 2-6  | Load a document onto the flatbed scanner .....             | 26 |
| Figure 2-7  | Load documents into the ADF (1 of 2) .....                 | 27 |
| Figure 2-8  | Load documents into the ADF (2 of 2) .....                 | 27 |
| Figure 3-1  | Replace the tray 2 pickup roller (1 of 7) .....            | 40 |
| Figure 3-2  | Replace the tray 2 pickup roller (2 of 7) .....            | 41 |
| Figure 3-3  | Replace the tray 2 pickup roller (3 of 7) .....            | 41 |
| Figure 3-4  | Replace the tray 2 pickup roller (4 of 7) .....            | 42 |
| Figure 3-5  | Replace the tray 2 pickup roller (5 of 7) .....            | 42 |
| Figure 3-6  | Replace the tray 2 pickup roller (6 of 7) .....            | 43 |
| Figure 3-7  | Replace the tray 2 pickup roller (7 of 7) .....            | 43 |
| Figure 3-8  | Replace the tray 2 or tray 3 separation pad (1 of 6) ..... | 45 |
| Figure 3-9  | Replace the tray 2 or tray 3 separation pad (2 of 6) ..... | 45 |
| Figure 3-10 | Replace the tray 2 or tray 3 separation pad (3 of 6) ..... | 46 |
| Figure 3-11 | Replace the tray 2 or tray 3 separation pad (4 of 6) ..... | 46 |
| Figure 3-12 | Replace the tray 2 or tray 3 separation pad (5 of 6) ..... | 47 |
| Figure 3-13 | Replace the tray 2 or tray 3 separation pad (6 of 6) ..... | 47 |
| Figure 3-14 | Clean the scanner glass (1 of 2) .....                     | 49 |
| Figure 3-15 | Clean the scanner glass (2 of 2) .....                     | 50 |
| Figure 3-16 | Clean the scanner-cover backing .....                      | 51 |
| Figure 3-17 | Clean the tray 2 pickup roller (1 of 6) .....              | 52 |
| Figure 3-18 | Clean the tray 2 pickup roller (2 of 6) .....              | 52 |
| Figure 3-19 | Clean the tray 2 pickup roller (3 of 6) .....              | 52 |
| Figure 3-20 | Clean the tray 2 pickup roller (4 of 6) .....              | 53 |
| Figure 3-21 | Clean the tray 2 pickup roller (5 of 6) .....              | 53 |
| Figure 3-22 | Clean the tray 2 pickup roller (6 of 6) .....              | 54 |
| Figure 3-23 | Clean the ADF pickup-roller assembly (1 of 5) .....        | 55 |
| Figure 3-24 | Clean the ADF pickup-roller assembly (2 of 5) .....        | 55 |
| Figure 3-25 | Clean the ADF pickup-roller assembly (3 of 5) .....        | 55 |
| Figure 3-26 | Clean the ADF pickup-roller assembly (4 of 5) .....        | 56 |
| Figure 3-27 | Clean the ADF pickup-roller assembly (5 of 5) .....        | 56 |
| Figure 4-1  | HP LaserJet M2727 MFP system block diagram .....           | 70 |
| Figure 4-2  | Optical system .....                                       | 72 |
| Figure 4-3  | ADF paper path .....                                       | 74 |
| Figure 4-4  | Cross-section of printer .....                             | 76 |

|             |   |     |
|-------------|---|-----|
| Figure 4-5  | Engine control system .....                           | 78  |
| Figure 4-6  | Engine-control-system circuit diagram .....           | 79  |
| Figure 4-7  | Laser/scanner system .....                            | 80  |
| Figure 4-8  | Pickup/feed/delivery system .....                     | 82  |
| Figure 4-9  | Image-formation system .....                          | 83  |
| Figure 4-10 | Primary charging .....                                | 83  |
| Figure 4-11 | Developing .....                                      | 84  |
| Figure 4-12 | Transfer .....  | 85  |
| Figure 4-13 | Separation .....                                      | 85  |
| Figure 4-14 | Fusing .....  | 86  |
| Figure 4-15 | Drum cleaning .....                                   | 86  |
| Figure 5-1  | Phillips and pozidrive screwdriver comparison .....   | 95  |
| Figure 5-2  | Parts-removal tree .....                              | 98  |
| Figure 5-3  | Remove the print cartridge (1 of 2) .....             | 99  |
| Figure 5-4  | Remove the print cartridge (2 of 2) .....             | 99  |
| Figure 5-5  | Remove the right cover (1 of 4) .....                 | 100 |
| Figure 5-6  | Remove the right cover (2 of 4) .....                 | 100 |
| Figure 5-7  | Remove the right cover (3 of 4) .....                 | 101 |
| Figure 5-8  | Remove the right cover (4 of 4) .....                 | 101 |
| Figure 5-9  | Remove the left cover (1 of 3) .....                  | 102 |
| Figure 5-10 | Remove the left cover (2 of 3) .....                  | 102 |
| Figure 5-11 | Remove the left cover (3 of 3) .....                  | 103 |
| Figure 5-12 | Remove the print-cartridge door (1 of 3) .....        | 104 |
| Figure 5-13 | Remove the print-cartridge door (2 of 3) .....        | 104 |
| Figure 5-14 | Remove the print-cartridge door (3 of 3) .....        | 105 |
| Figure 5-15 | Remove the rear cover (1 of 3) .....                  | 106 |
| Figure 5-16 | Remove the rear cover (2 of 3) .....                  | 106 |
| Figure 5-17 | Remove the rear cover (3 of 3) .....                  | 107 |
| Figure 5-18 | Remove the top cover (1 of 4) .....                   | 108 |
| Figure 5-19 | Remove the top cover (2 of 4) .....                   | 108 |
| Figure 5-20 | Remove the top cover (3 of 4) .....                   | 109 |
| Figure 5-21 | Remove the top cover (4 of 4) .....                   | 109 |
| Figure 5-22 | Replace the ADF pickup-roller assembly (1 of 6) ..... | 110 |
| Figure 5-23 | Replace the ADF pickup-roller assembly (2 of 6) ..... | 110 |
| Figure 5-24 | Replace the ADF pickup-roller assembly (3 of 6) ..... | 111 |
| Figure 5-25 | Replace the ADF pickup-roller assembly (4 of 6) ..... | 111 |
| Figure 5-26 | Replace the ADF pickup-roller assembly (5 of 6) ..... | 112 |
| Figure 5-27 | Replace the ADF pickup-roller assembly (6 of 6) ..... | 112 |
| Figure 5-28 | Removing the ADF scanner glass (1 of 3) .....         | 113 |
| Figure 5-29 | Removing the ADF scanner glass (2 of 3) .....         | 113 |
| Figure 5-30 | Removing the ADF scanner glass (3 of 3) .....         | 114 |
| Figure 5-31 | Remove the ADF assembly (1 of 3) .....                | 115 |
| Figure 5-32 | Remove the ADF assembly (2 of 3) .....                | 115 |
| Figure 5-33 | Remove the ADF assembly (3 of 3) .....                | 116 |
| Figure 5-34 | Remove the scanner/ADF assembly (1 of 4) .....        | 117 |
| Figure 5-35 | Remove the scanner/ADF assembly (2 of 4) .....        | 117 |
| Figure 5-36 | Remove the scanner/ADF assembly (3 of 4) .....        | 118 |
| Figure 5-37 | Remove the scanner/ADF assembly (4 of 4) .....        | 118 |
| Figure 5-38 | Remove the bezel and control panel (1 of 4) .....     | 119 |
| Figure 5-39 | Remove the bezel and control panel (2 of 4) .....     | 119 |

|             |  |     |
|-------------|--|-----|
| Figure 5-40 | Remove the bezel and control panel (3 of 4)              | 120 |
| Figure 5-41 | Remove the bezel and control panel (4 of 4)              | 121 |
| Figure 5-42 | Remove the convenience-stapler assembly (1 of 2)         | 122 |
| Figure 5-43 | Remove the convenience-stapler assembly (2 of 2)         | 123 |
| Figure 5-44 | Remove the convenience-stapler power assembly (1 of 3)   | 124 |
| Figure 5-45 | Remove the convenience-stapler power assembly (2 of 3)   | 124 |
| Figure 5-46 | Remove the convenience-stapler power assembly (3 of 3)   | 125 |
| Figure 5-47 | Remove the convenience-stapler AC inlet cable            | 126 |
| Figure 5-48 | Remove the convenience-stapler bracket and strap         | 127 |
| Figure 5-49 | Remove the speaker (1 of 2)                              | 128 |
| Figure 5-50 | Remove the speaker (2 of 2)                              | 129 |
| Figure 5-51 | Remove the power-switch PCA (HP LaserJet M2727nfs shown) | 130 |
| Figure 5-52 | Remove the power-switch PCA mounting bracket             | 131 |
| Figure 5-53 | Remove the formatter (1 of 5)                            | 132 |
| Figure 5-54 | Remove the formatter (2 of 5)                            | 133 |
| Figure 5-55 | Install formatter protective sheet                       | 133 |
| Figure 5-56 | Remove the formatter (3 of 4)                            | 134 |
| Figure 5-57 | Remove the formatter (4 of 4)                            | 134 |
| Figure 5-58 | Remove the duplex assembly (1 of 2)                      | 135 |
| Figure 5-59 | Remove the duplex assembly (2 of 2)                      | 136 |
| Figure 5-60 | Remove the laser/scanner assembly                        | 138 |
| Figure 5-61 | Remove the memory-tag-reader assembly (1 of 2)           | 139 |
| Figure 5-62 | Remove the memory-tag-reader assembly (2 of 2)           | 140 |
| Figure 5-63 | Memory-tag-reader assembly spring                        | 140 |
| Figure 5-64 | Remove the fan (1 of 2)                                  | 141 |
| Figure 5-65 | Remove the fan (2 of 2)                                  | 142 |
| Figure 5-66 | Remove the duplex-drive gears                            | 144 |
| Figure 5-67 | Replace the duplex-drive gears                           | 144 |
| Figure 5-68 | Remove the duplex solenoid (1 of 2)                      | 145 |
| Figure 5-69 | Remove the duplex solenoid (2 of 2)                      | 146 |
| Figure 5-70 | Remove the fuser (1 of 9)                                | 147 |
| Figure 5-71 | Remove the fuser (2 of 9)                                | 148 |
| Figure 5-72 | Remove the fuser (3 of 9)                                | 148 |
| Figure 5-73 | Remove the fuser (4 of 9)                                | 149 |
| Figure 5-74 | Remove the fuser (5 of 9)                                | 149 |
| Figure 5-75 | Remove the fuser (6 of 9)                                | 150 |
| Figure 5-76 | Remove the fuser (7 of 9)                                | 150 |
| Figure 5-77 | Remove the fuser (8 of 9)                                | 151 |
| Figure 5-78 | Remove the fuser (9 of 9)                                | 151 |
| Figure 5-79 | Remove the interlock assembly                            | 152 |
| Figure 5-80 | Remove the ECU (1 of 7)                                  | 154 |
| Figure 5-81 | Remove the ECU (2 of 7)                                  | 154 |
| Figure 5-82 | Remove the ECU (3 of 7)                                  | 155 |
| Figure 5-83 | Remove the ECU (4 of 7)                                  | 155 |
| Figure 5-84 | Remove the ECU (5 of 8)                                  | 156 |
| Figure 5-85 | Remove the ECU (6 of 7)                                  | 156 |
| Figure 5-86 | Remove the ECU (7 of 7)                                  | 157 |
| Figure 5-87 | Remove the main motor (1 of 2)                           | 158 |
| Figure 5-88 | Remove the main motor (2 of 2)                           | 159 |
| Figure 5-89 | Remove the transfer roller                               | 160 |

|             |   |     |
|-------------|---|-----|
| Figure 5-90 | Remove the registration-roller assembly .....                     | 161 |
| Figure 5-91 | Remove the main gear assembly (1 of 5) .....                      | 162 |
| Figure 5-92 | Remove the main gear assembly (2 of 5) .....                      | 163 |
| Figure 5-93 | Remove the main gear assembly (3 of 5) .....                      | 163 |
| Figure 5-94 | Remove the main gear assembly (4 of 5) .....                      | 164 |
| Figure 5-95 | Remove the tray 2 pickup solenoid (5 of 5) .....                  | 164 |
| Figure 6-1  | Engine test switch .....  | 231 |
| Figure 6-2  | Print-cartridge high-voltage connection points (right side) ..... | 233 |
| Figure 6-3  | Print-cartridge high-voltage connection points (left side) .....  | 234 |
| Figure 7-1  | Interface connectors .....  | 260 |
| Figure 7-2  | Formatter connectors .....  | 260 |
| Figure 7-3  | Fax card connectors .....   | 261 |
| Figure 7-4  | Solenoids .....   | 262 |
| Figure 7-5  | Switches and sensors .....  | 263 |
| Figure 7-6  | Rollers and pads .....  | 264 |
| Figure 7-7  | PCAs (base unit) .....  | 265 |
| Figure 7-8  | Major components (base unit) .....                                | 266 |
| Figure 7-9  | Scanner and ADF .....   | 267 |
| Figure 7-10 | Circuit diagram (1 of 2) .....                                    | 268 |
| Figure 7-11 | Circuit diagram (2 of 2) .....                                    | 269 |
| Figure 7-12 | Scanner and ADF assemblies .....                                  | 272 |
| Figure 7-13 | Scanner assemblies .....  | 274 |
| Figure 7-14 | ADF components .....  | 276 |
| Figure 7-15 | Convenience stapler components (HP LaserJet M2727nfs only) .....  | 278 |
| Figure 7-16 | Formatter, fax card, HP jewel, and nameplate .....                | 280 |
| Figure 7-17 | External covers and panels .....                                  | 282 |
| Figure 7-18 | Cartridge door assembly .....                                     | 284 |
| Figure 7-19 | Internal components (1 of 4) .....                                | 286 |
| Figure 7-20 | Internal components (2 of 4) .....                                | 288 |
| Figure 7-21 | Internal components (3 of 4) .....                                | 290 |
| Figure 7-22 | Internal components (4 of 4) .....                                | 292 |
| Figure 7-23 | Engine-controller assembly .....                                  | 294 |
| Figure 7-24 | Main-drive assembly .....   | 296 |
| Figure 7-25 | Duplexing-drive assembly .....                                    | 298 |
| Figure 7-26 | Tray 2 cassette and tray 3 cassette/feeder .....                  | 300 |
| Figure 7-27 | Duplexing assembly .....  | 302 |
| Figure 7-28 | Fuser assembly .....  | 304 |

---

# 1 Product information

- [Quick access to product information](#)
- [Product comparison](#)
- [Product features](#)
- [Product walkaround](#)
- [Serial number and model number location](#)
- [Software description](#)
- [Software for Windows](#)
- [Software for Macintosh](#)
- [Uninstall software](#)
- [Media specifications](#)

## Quick access to product information

Use the following Web site to find information about the product.

- [www.hp.com/support/LJM2727](http://www.hp.com/support/LJM2727)

**Table 1-1 Product guides**

| Guide  | Description   |
|--|---|
| <i>HP LaserJet M2727 MFP Getting Started Guide</i> | Provides step-by-step instructions for installing and setting up the product.   |
| <i>HP LaserJet M2727 MFP Series User Guide</i>     | Provides detailed information for using the product and problem-solving. Available on the product CD or in the Windows <b>Program Group</b> if the software is installed on a computer.   |
| HP ToolboxFX                                       | To check the product status and settings, and to view problem-solving information and online documentation, use the HP ToolboxFX. You must have performed a complete software installation in order to use the HP ToolboxFX. See the user guide for more information about software installation. |
| Online Help  | Provides information about options that are available in the printer drivers. To view a Help file, open the online Help through the printer driver.   |



# Product comparison

The product is available in the following configurations.

---

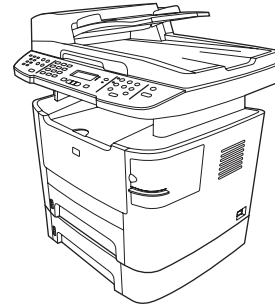
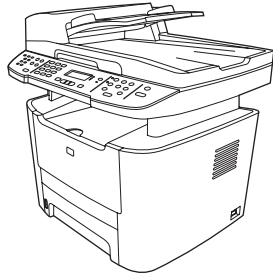

---

## HP LaserJet M2727nf MFP

- Prints letter-size pages at speeds up to 27 pages per minute (ppm) and A4-size pages at speeds up to 26 ppm.
- PCL 5 and PCL 6 printer drivers and HP postscript level 3 emulation.
- Tray 1 holds up to 50 sheets of print media or up to 5 envelopes.
- Tray 2 holds up to 250 sheets of print media.
- Optional 250-sheet input tray (tray 3) available.
- Automatic two-sided (duplex) printing, fax receiving, and copying.
- Average yield for the standard black print cartridge is 3,500 pages, in accordance with ISO/IEC 19752. Actual yield depends on specific use.
- Average yield for the high-capacity print cartridge is 7,000 pages, in accordance with ISO/IEC 19752. Actual yield depends on specific use.
- Hi-Speed USB 2.0 port and 10/100 Base-T network port.
- V.34 fax modem and 8-megabyte (MB) flash fax-storage memory.
- Two RJ-11 fax phone line ports.
- 64-MB random-access memory (RAM).
- Flatbed scanner and 50-page automatic document feeder (ADF).
- One available DIMM slot for memory expansion (up to 320 MB).

---

## HP LaserJet M2727nfs MFP

HP LaserJet M2727nf MFP, plus:

- Additional 250-sheet input tray (tray 3) included.
  - Convenience stapler.
-

# Product features

---

|                                |   |
|--------------------------------|---|
| <b>Performance</b>             | <ul style="list-style-type: none"><li>● Prints up to 27 ppm (letter) or 26 ppm (A4).</li></ul>  |
| <b>Print quality</b>           | <ul style="list-style-type: none"><li>● 1,200 dots per inch (dpi) with Image REt 2400 text and graphics.</li><li>● Adjustable settings to optimize print quality.</li><li>● The HP UltraPrecise print cartridge has a finer toner formulation that provides sharper text and graphics.</li></ul>  |
| <b>Fax</b>                     | <ul style="list-style-type: none"><li>● Full-functionality fax capabilities with a V.34 fax; includes a phone book, fax/tel, and delayed-fax features.</li></ul>  |
| <b>Copy</b>                    | <ul style="list-style-type: none"><li>● Includes ADF that allows faster, more efficient copy jobs with multiple-page documents.</li></ul>   |
| <b>Scan</b>                    | <ul style="list-style-type: none"><li>● The product provides 1,200 pixels per inch (ppi), 24-bit full-color scanning from letter/A4-size scanner glass.</li><li>● The product provides 300 ppi, 24-bit full-color scanning from the automatic document feeder (ADF).</li><li>● Includes an ADF that allows faster, more efficient scan jobs with multiple-page documents.</li></ul> |
| <b>Staple</b>                  | <ul style="list-style-type: none"><li>● The HP LaserJet M2727nfs includes a convenience stapler for fast and convenient stapling of up to 20 sheets of 80 g/m<sup>2</sup> or 20 lb media at the product.</li><li>● Large-capacity replaceable staple cassette holds 1,500 staples.</li></ul>  |
| <b>Networking</b>              | <ul style="list-style-type: none"><li>● TCP/IP<ul style="list-style-type: none"><li>◦ IPv4</li><li>◦ IPv6</li></ul></li></ul>   |
| <b>Printer driver features</b> | <ul style="list-style-type: none"><li>● Fast printing performance, built-in Intellifont and TrueType scaling technologies, and advanced imaging capabilities are benefits of the PCL 6 printer language.</li></ul>  |
| <b>Interface connections</b>   | <ul style="list-style-type: none"><li>● Hi-Speed USB 2.0 port.</li><li>● 10/100 Base-T ethernet network port (RJ-45).</li><li>● RJ-11 fax/phone cable ports.</li></ul>  |
| <b>Economical printing</b>     | <ul style="list-style-type: none"><li>● N-up printing (printing more than one page on a sheet).</li><li>● Two-sided printing using the automatic duplexer.</li><li>● EconoMode setting.</li></ul>   |
| <b>Supplies</b>                | <ul style="list-style-type: none"><li>● A supplies status page that displays the amount of life remaining in the print cartridge.</li><li>● No-shake cartridge design.</li><li>● Authentication for HP print cartridges.</li><li>● Enabled supplies-ordering capability.</li></ul>  |
| <b>Accessibility</b>           | <ul style="list-style-type: none"><li>● Online user guide that is compatible with text screen-readers.</li><li>● Print cartridges can be installed and removed using one hand.</li><li>● All doors and covers can be opened using one hand.</li></ul>   |

---

# Product walkaround

## Front view

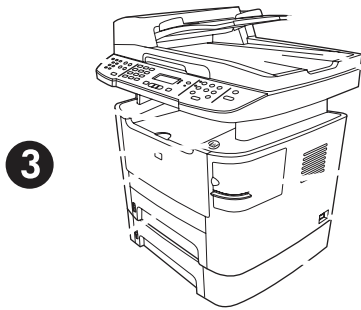

|    |  |
|----|--|
| 1  | Tray 2   |
| 2  | Tray 1   |
| 3  | Print-cartridge door latch                                 |
| 4  | Top (face-down) output bin                                 |
| 5  | Control panel  |
| 6  | Automatic document feeder (ADF) input tray                 |
| 7  | Automatic document feeder (ADF) output bin                 |
| 8  | Convenience stapler (HP LaserJet M2727nfs only)            |
| 9  | Power switch   |
| 10 | Optional tray 3 (standard on the HP LaserJet M2727nfs MFP) |

## Back view

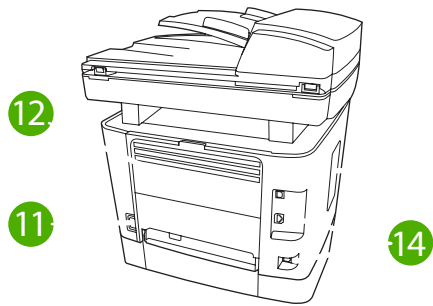

|    |  |
|----|--|
| 11 | Power connector  |
| 12 | Rear output door (face-up output bin for the straight-through output path) |
| 13 | DIMM door  |
| 14 | Interface ports  |

## Interface ports

The product has a 10/100 Base-T (RJ-45) network port, a Hi-Speed USB 2.0 port, and fax ports.

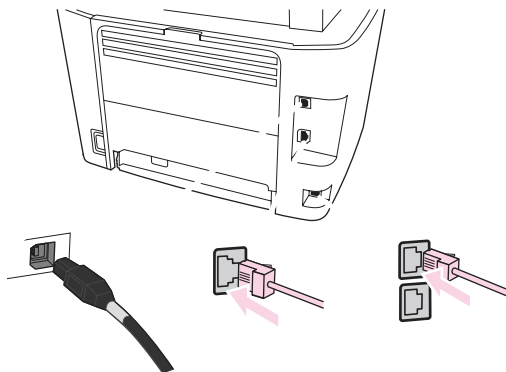

|   |                       |
|---|-----------------------|
| 1 | Hi-Speed USB 2.0 port |
| 2 | Network port          |
| 3 | Fax ports             |

## Control panel

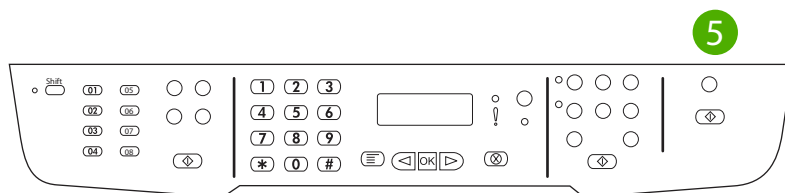

- |   |  |
|---|--|
| 1 | <b>Fax controls.</b> Use the fax controls to change commonly used fax settings.  |
| 2 | <b>Alphanumeric buttons.</b> Use the alphanumeric buttons to type data into the product control-panel display and dial telephone numbers for faxing. |
| 3 | <b>Setup and cancel controls.</b> Use these controls to select menu options, determine the product status, and cancel the current job.               |
| 4 | <b>Copy controls.</b> Use these controls to change commonly used default settings and to start copying.  |
| 5 | <b>Scan controls.</b> Use these controls to scan to e-mail or to a folder.   |

# Serial number and model number location

The serial number and product model number label is on the rear output bin door at the back of the product.

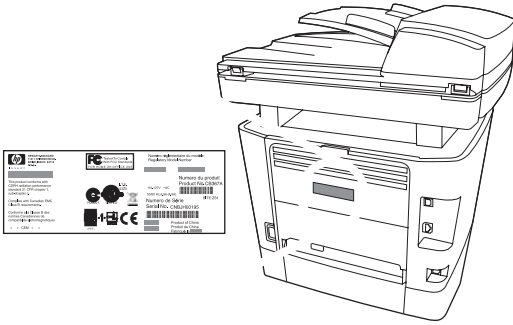

# Software description

## Supported operating systems

The product supports the following operating systems:

### Full software installation

- Windows XP (32-bit and 64-bit)
- Windows Vista (32-bit and 64-bit)
- Mac OS X v10.3, v10.4, and later

### Print and scan driver

- Windows 98
- Windows 2000
- Windows 2003 Server (32-bit and 64-bit)

### Printer driver only

- Linux (Web only)
- UNIX model scripts (Web only)

 **NOTE:** For Mac OS X v10.4 and later, PPC and Intel Core Processor Macs are supported.

## Supported printer drivers

The following printer drivers are provided. If the printer driver you want is not on the product CD or is not available on [www.hp.com](http://www.hp.com), contact the manufacturer or distributor of the program that you are using, and request a driver for the product.

 **NOTE:** The most recent drivers are available at [www.hp.com](http://www.hp.com). Depending on the configuration of Windows-based computers, the installation program for the product software automatically checks the computer for Internet access to obtain the latest drivers.

**Table 1-2 Supported printer drivers**

| Operating system <sup>1</sup>     | Fax driver | PCL 6 printer driver | PCL 5 printer driver | PS printer driver | PPD <sup>2</sup> printer driver |
|-----------------------------------|------------|----------------------|----------------------|-------------------|---------------------------------|
| Microsoft Windows 98              |            | X                    | X                    | X                 |                                 |
| Microsoft Millennium Edition (Me) |            | X                    | X                    | X                 |                                 |
| Windows 2000                      | X          | X                    | X                    | X                 |                                 |
| Windows XP                        | X          | X                    | X                    | X                 |                                 |
| Windows Server 2003               |            | X                    | X                    | X                 |                                 |
| Mac OS X v10.3, v10.4, and later  | X          |                      |                      | X                 | X                               |

<sup>1</sup> Not all product features are available from all drivers or operating systems. See the context-sensitive help in the printer driver for available features.

<sup>2</sup> A Macintosh printer driver and the necessary PostScript (PS) Printer Description Files (PPDs) are included with the product.

## Software included with the product

There are several options for completing a recommended installation. Easy Install will complete the installation with default settings. Advanced Install allows you to select custom settings and choose the components that are installed.

## Recommended installation for Windows

- HP drivers
  - PCL 6 printer driver
  - Scan driver
- HP MFP software
  - HP ToolboxFX
  - HP LaserJet Scan program
  - HP Send Fax program and driver
  - HP Fax Setup Wizard
  - Uninstall program
- HP Update program
- HP Customer Participation Program
- Shop for HP Supplies program
- Other programs
  - Readiris OCR (not installed with other software; separate installation is required)

## Express installation (USB or network)

The following software is included with an Express installation:

- PCL 6 printer driver
- HP LaserJet Scan program and driver

---

 **NOTE:** Express installation supports faxing by using the control panel.

**NOTE:** PCL 5 and HP postscript level 3 emulation drivers can be installed using the Microsoft Add Printer wizard.

---

## Macintosh software

- HP Product Setup Assistant
- HP Device Configuration
- HP Uninstaller
- HP LaserJet software
  - HP Scan
  - HP Director
  - Fax program



- Scan to e-mail program
- HP Photosmart

## Software for Windows

When you install the software for Windows, you can directly connect the product to a computer by using a USB cable, or you can connect the product to a network by using the internal print server. See the getting started guide for installation instructions, and see the Readme file for the latest software information.

## HP ToolboxFX

Perform a typical installation in order to use HP ToolboxFX.

HP ToolboxFX provides links to product status information and Help information, such as the user guide, and tools for product problem-solving. See [HP ToolboxFX on page 58](#).

## Embedded Web server (EWS)

The EWS is a Web-based interface that provides simple access to product status and configurations, including network configurations and Smart Printing Supplies (SPS) functionality.

You can gain access to the EWS through the network connection to the product. Type the product IP address in a Web browser to open the product EWS home page in the browser. From the home page, you can use the tabs and left navigation menu to check the status of the product, configure the product, or check the status of the supplies.

The following are supported browsers:

- Internet Explorer 5.0 or later
- Netscape Navigator 4.75 or later
- Opera 6.05 or later
- Safari 1.2 or later

# Software for Macintosh

For Mac OS X v10.3, v10.4, and later, use Print Center to print.

---

 **NOTE:** For Macintosh computers, HP ToolboxFX is *not* supported.

---

## HP Director

HP Director is a software program for working with documents. When the document is loaded into the ADF and the computer is connected directly to the product, HP Director appears on the computer screen to initiate faxing, scanning, or changing settings on the product through Macintosh Configure Device.

Also included is the HP product Setup Assistant, which sets up the fax and print queues.

## Macintosh Configure Device (Mac OS X v10.3, v10.4, and later)

Macintosh Configure Device is a Web-based program that provides access to information about the product (or example, information about supplies status and product settings). Use Macintosh Configure Device to monitor and manage the product from the computer.

---

 **NOTE:** You must perform a complete software installation to use Macintosh Configure Device.

---

- Check the product status and print information pages.
- Check and change product settings.
- Check default print settings.
- Check and change fax settings, including IP configuration, Advanced, mDNS, SNMP, network configuration, and fax reports.

You can view Macintosh Configure Device when the product is directly connected to a computer or when it is connected to the network.

---

 **NOTE:** You do not have to have Internet access to open and use Macintosh Configure Device.

---

### To view Macintosh Configure Device when the product is connected to the computer

1. Open HP Director by clicking the **HP Director** icon in the dock.
2. In HP Director, click **Settings**.
3. Select **Configure Device** to open the Macintosh Configure Device home page in a browser.

### To view Macintosh Configure Device when the product is connected to the network

1. Open one of the following browsers:
  - Internet Explorer 5.0 or later
  - Netscape Navigator 4.75 or later
  - Opera 6.05 or later
  - Safari 1.2 or later
2. Type the IP address of the product into the Web browser to open the Macintosh Configure Device home page.

## **PDEs (Mac OS X v10.3, v10.4, and later)**

PDEs are code plug-ins that provide access to product features, such as information about the number of copies, two-sided printing, and quality settings. An installation program for the PDEs and other software is provided on the product CD for Macintosh.

# Uninstall software

## Windows

Use the **Add or Remove Programs** method in Windows to remove the product software. This method does *not* require you to have the software CD.

1. Click **Start**, point to **Settings**, and then click **Control Panel**.

---

 **NOTE:** In Windows XP, click **Start**, and then click **Control panel**.

---

2. Double-click **Add or Remove Programs**.
3. Scroll through the list of software programs and click **HP LaserJet M2727**.
4. Click **Remove**.

## Macintosh

To remove the software, drag the PPD files to the trash can.

# Media specifications

## Supported paper and print media sizes

 **NOTE:** See the user guide for information about using media correctly.

This product supports a number of paper sizes, and it adapts to various media.

 **NOTE:** To obtain best print results, select the appropriate paper size and type in the print driver before printing. Use conventional 75 to 90 g/m<sup>2</sup> (20 to 24 lb) photocopy paper. Verify that the paper is of good quality and is free of cuts, nicks, tears, spots, loose particles, dust, wrinkles, curls, and bent edges.

**Table 1-3 Supported paper and print media sizes**

| Size                    | Dimensions  | Tray 1 | Trays 2 and 3 |
|-------------------------|---|--------|---------------|
| Letter                  | 216 x 279 mm (8.5 x 11 inches)  | ✓      | ✓             |
| Legal                   | 216 x 356 mm (8.5 x 14 inches)  | ✓      | ✓             |
| A4                      | 210 x 297 mm (8.27 x 11.69 inches)  | ✓      | ✓             |
| Executive               | 184 x 267 mm (7.24 x 10.51 inches)  | ✓      | ✓             |
| A3                      | 297 x 420 mm (11.69 x 16.54 inches)   |        |               |
| A5                      | 148 x 210 mm (5.83 x 8.27 inches)   | ✓      | ✓             |
| A6                      | 105 x 148 mm (4.13 x 5.83 inches)   | ✓      |               |
| B5 (JIS)                | 182 x 257 mm (7.17 x 10.12 inches)  | ✓      | ✓             |
| 16k                     | 197 x 273 mm (7.75 x 10.75 inches)  | ✓      |               |
| 16k                     | 195 x 270 mm (7.7 x 10.6 inches)  | ✓      |               |
| 16k                     | 184 x 260 mm (7.25 x 10.25 inches)  | ✓      |               |
| 8.5 x 13                | 216 x 330 mm (8.5 x 13 inches)  | ✓      | ✓             |
| 4 x 6 <sup>1</sup>      | 107 x 152 mm (4 x 6 inches)   | ✓      |               |
| 5 x 8 <sup>1</sup>      | 127 x 203 mm (5 x 8 inches)   | ✓      |               |
| 10 x 15 cm <sup>1</sup> | 100 x 150 mm (3.9 x 5.9 inches)   | ✓      |               |
| Custom                  | <b>Tray 1:</b> Minimum—76 x 127 mm (3 x 5 inches);<br>Maximum—216 x 356 mm (8.5 x 14 inches)          | ✓      |               |
|                         | <b>Trays 2 and 3:</b> Minimum—148 x 210 mm (5.8 x 8.3 inches); Maximum—216 x 356 mm (8.5 x 14 inches) |        | ✓             |

<sup>1</sup> These sizes are supported as custom sizes.

**Table 1-4 Supported envelopes and postcards**

| Size             | Dimensions                        | Tray 1 | Trays 2 and 3  |
|------------------|-----------------------------------|--------|----------------|
| Envelope #10     | 105 x 241 mm (4.13 x 9.49 inches) | ✓      | Not supported. |
| Envelope DL      | 110 x 220 mm (4.33 x 8.66 inches) | ✓      | Not supported. |
| Envelope C5      | 162 x 229 mm (6.93 x 9.84 inches) | ✓      | Not supported. |
| Envelope B5      | 176 x 250 mm (6.7 x 9.8 inches)   | ✓      | Not supported. |
| Envelope Monarch | 98 x 191 mm (3.9 x 7.5 inches)    | ✓      | Not supported. |
| Postcard         | 100 x 148 mm (3.94 x 5.83 inches) | ✓      | Not supported. |
| Double postcard  | 148 x 200 mm (5.83 x 7.87 inches) | ✓      | Not supported. |

**Table 1-5 ADF**

| Media        | Dimensions                     | Weight                                 | Capacity  |
|--------------|--------------------------------|--|-----------|
| Minimum-size | 127 x 127 mm (5 x 5 inches)    | 60 to 90 gm <sup>2</sup> (16 to 24 lb) | 50 sheets |
| Maximum-size | 216 x 381 mm (8.5 x 15 inches) |  |           |

 **NOTE:** When faxing, copying, or scanning using the product, use the flatbed scanner if the original is fragile, thin, thick, too small for the ADF, or a photograph. Also use the flatbed scanner for the fit-to-page copying feature. The flatbed scanner provides the best fax, copy, and scan resolution.

## Media to avoid

The product can handle many types of media. Using media that is outside the specifications degrades print quality and increases the chance of jams occurring.

- Do not use media that is too rough.
- Do not use media that contains cutouts or perforations other than standard 3-hole punched paper.
- Do not use multipart forms.
- Do not use paper that contains a watermark if you are printing solid patterns.

## Media that can damage the product

In rare circumstances, media can damage the product. Avoid the following types of media to prevent possible damage:

- Do not use media with staples attached.
- Do not use transparencies designed for inkjet printers or other low-temperature printers. Use only transparencies that are specified for use with HP LaserJet printers.
- Do not use photo paper intended for inkjet printers.

- Do not use paper that is embossed or coated and is not designed for the temperature of the image-fuser. Select media that can tolerate temperatures of 200°C (392°F) for 0.1 second. HP manufactures a media that is designed for the product.
- Do not use letterhead paper that was produced with low-temperature dyes or thermography. Preprinted forms or letterhead must use inks that can tolerate temperatures of 200°C (392°F) for 0.1 second.
- Do not use any media that produces emissions, or that melts, offsets, or discolors when exposed to 200°C (392°F) for 0.1 second.

To order HP LaserJet printing supplies, go to [www.hp.com/go/ljsupplies](http://www.hp.com/go/ljsupplies) in the U.S., or go to [www.hp.com/go/ljsupplies](http://www.hp.com/go/ljsupplies) worldwide.



---

## 2 Installation

- [Operating environment](#)
- [Unpack the product](#)
- [Install input devices](#)
- [Install the control-panel faceplate](#)
- [Load paper and print media](#)
- [Install memory DIMMs](#)

## Operating environment

Place the product on a sturdy, level surface in a well-ventilated area. Make sure that the air vents are not blocked and that the product is installed away from direct sunlight, open flames, and ammonia fumes.

Store or install the product in an area that meets the following requirements:

- Temperature (printer; operating) 15° to 32.5°C (59° to 90.5°F)
- Temperature (printer; storage) -20° to 60°C (-4° to 140°F)
- Humidity (printer; operating) 10% to 80% relative humidity (no condensation)
- Humidity (printer; storage) 10% to 90% relative humidity (no condensation)
- Temperature (toner cartridge; storage) -20° to 40° C (-4 to 104° F)
- Humidity (toner cartridge; storage) 10% to 90% relative humidity (no condensation)

**Figure 2-1** Operating environment

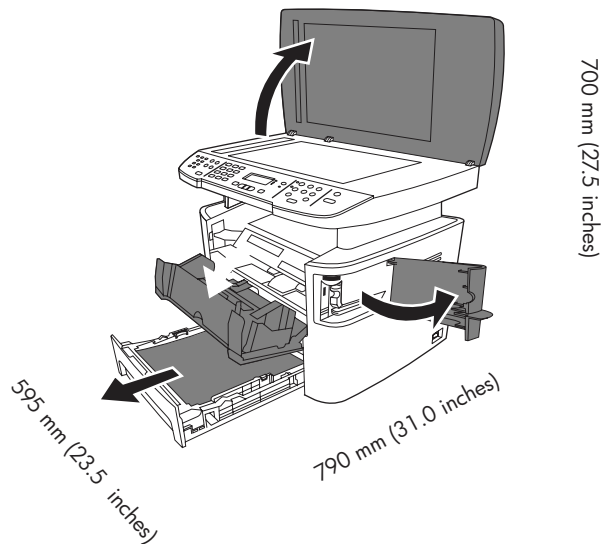

## Minimum system requirements

- Windows OS (Win 98, Win 2000, 2003 Server, Millennium Edition (Me), XP, or Vista)  
or  
Mac OS X v10.3 and later
- 128 MB RAM for Windows operating systems
- 32 MB RAM for Macintosh operating systems
- 250 MB hard-disk space (full installation)
- CD-ROM drive
- USB port

# Unpack the product

The following components are included in the box.

 **NOTE:** The USB and network cables are not included.

**Figure 2-2** HP LaserJet M2727 MFP package contents

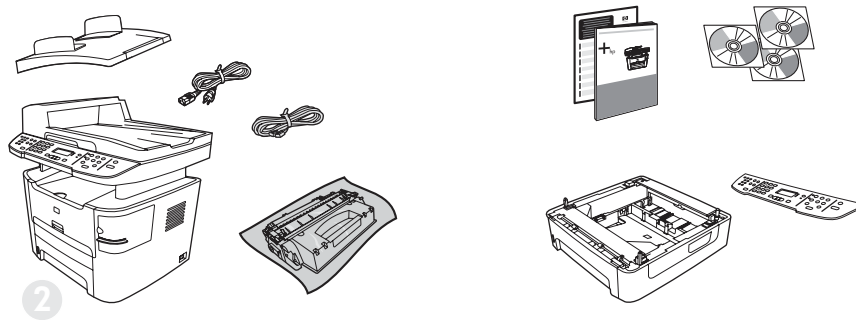

| Item | Description   |
|------|---|
| 1    | Automatic document feeder (ADF) input tray  |
| 2    | HP LaserJet M2727 MFP   |
| 3    | Power cord  |
| 4    | Fax cord  |
| 5    | Print cartridge   |
| 6    | Start guide and support flyer   |
| 7    | CD-ROMs (software and online user guide)  |
| 8    | 250-sheet media input tray (optional tray 3, standard on the HP LaserJet M2727nfs only) |
| 9    | Control-panel faceplate (if not already installed)                                      |

Installing the supplies (for example, the print cartridge) is similar to replacing them. See [Manage supplies on page 34](#) for more information about installing supplies.

# Install input devices

## ADF input tray

1. Open the ADF cover.
2. Align the two tabs on the input tray with the grooves in the ADF.
3. Slide the tray into the grooves until the tray snaps into place.
4. Close the ADF cover.

**Figure 2-3** Install the ADF input tray

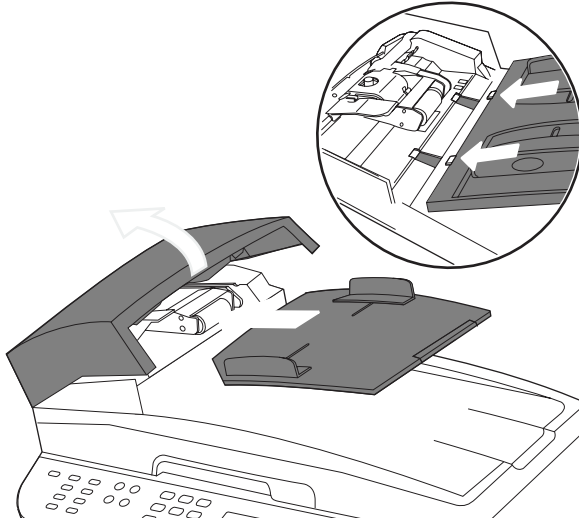

## 250-sheet input tray (tray 3)

**CAUTION:** Always install the 250-sheet tray (tray 3) in the location where the product will remain. The assembled combination is heavy, and cannot be easily moved.

1. Place the 250-sheet feeder (tray 3) on a sturdy, level surface.
2. Using the alignment pins at the corners of the tray as a guide place the product on top of the tray.
3. Make sure that the right-rear connector (callout 1) connects with the product.

**Figure 2-4** Install the 250-sheet input tray

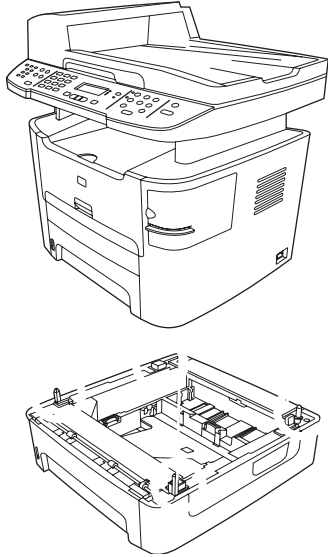

## Install the control-panel faceplate

 **NOTE:** The control-panel faceplate might already be installed.

---

1. Lift the scanner cover.
2. Align the control-panel faceplate with the product.
3. Beginning in the center of the faceplate and working outward, press the faceplate until it snaps into place.

**Figure 2-5** Install the control-panel faceplate

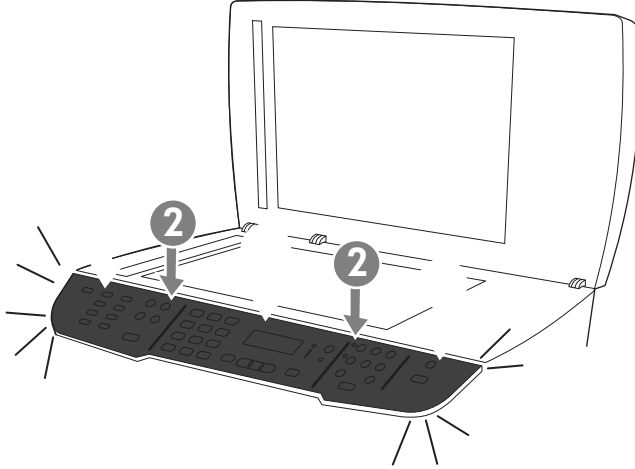

# Load paper and print media

## Load documents to fax, copy, or scan

 **NOTE:** For the best-quality scans, use the flatbed scanner.

---

### To load originals onto the flatbed scanner

1. Make sure that the automatic document feeder (ADF) contains no media.
2. Lift the scanner cover.
3. Place the original document face-down on the flatbed scanner glass with the upper-left corner of the document at the lower-right corner of the glass.

**Figure 2-6** Load a document onto the flatbed scanner

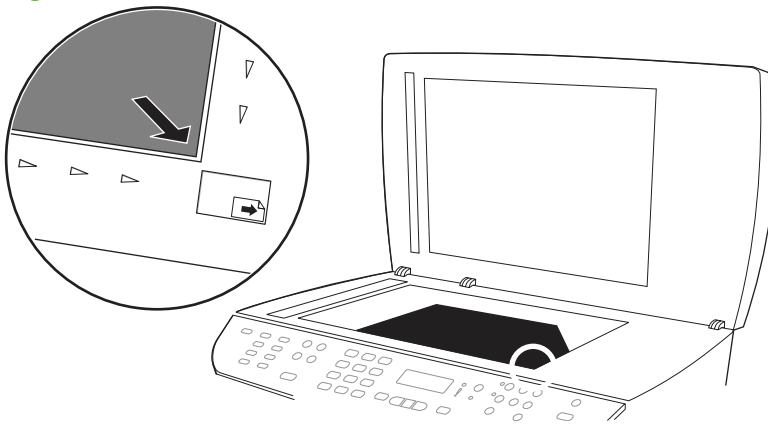

4. Gently close the scanner cover.

The document is ready to be faxed/copied/scanned.



## To load originals into the ADF

 **NOTE:** The ADF capacity for the product is up to 50 sheets of 75 g/m<sup>2</sup> (20 lb) media.

1. Insert the stack of originals into the ADF input tray top-edge-first, with the media stack face-up and the first page to be copied on the top of the stack. Slide the stack into the ADF until it does not move any farther.

**Figure 2-7** Load documents into the ADF (1 of 2)

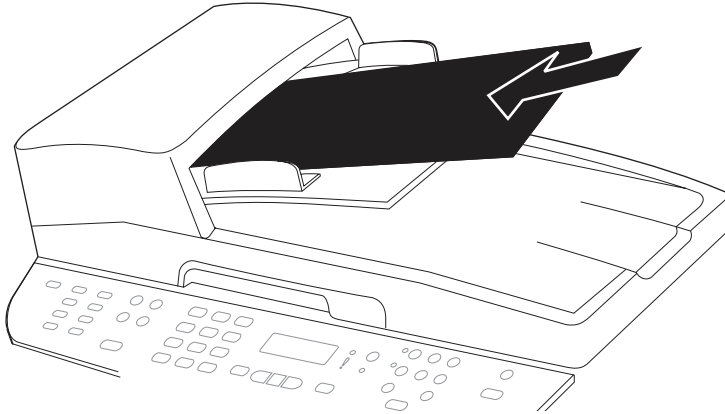

2. Adjust the media guides until they are snug against the stack.

**Figure 2-8** Load documents into the ADF (2 of 2)

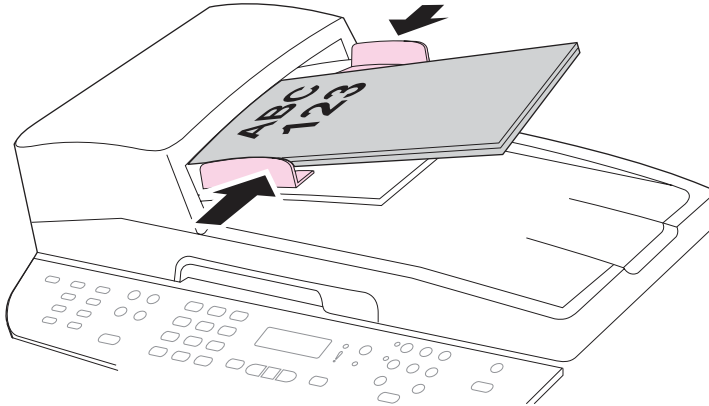

3. The document is ready to be faxed, copied, or scanned.

## Tray 1

Tray 1 is accessed from the front of the product. The product prints from tray 1 before attempting to print from other trays.

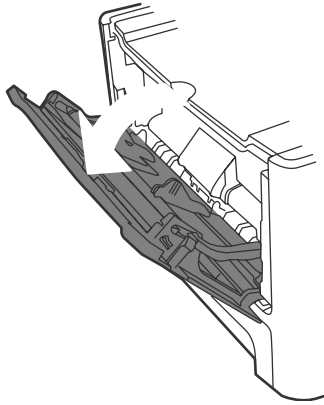

Tray 1 holds up to 50 sheets of 75 g/m<sup>2</sup> (20 lb) media or five envelopes, ten transparencies, or ten cards. You can use tray 1 to print the first page on media different from the remainder of the document.

Media guides ensure that the media is correctly fed into the product and that the print is not skewed (crooked on the media). When loading media, adjust the media guides to match the width of the media that you are using.

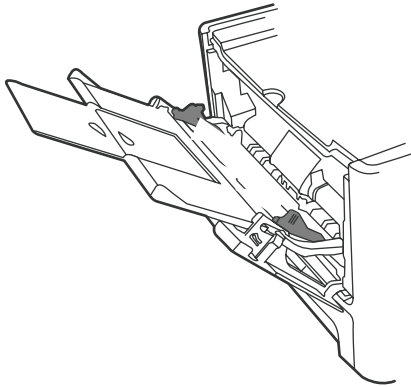

## Tray 2 or 3

Tray 2 and optional tray 3 hold up to 250 pages of 75 g/m<sup>2</sup> (20 lb) paper, or fewer pages of heavier media (25 mm (0.9 in) or less stack height). Load media with the top forward and the side to be printed on facing down.

Media guides ensure that the media feeds correctly into the product and that the print is not skewed. Tray 2 has side and rear media guides. When loading media, adjust the media guides to match the length and width of the media that you are using.

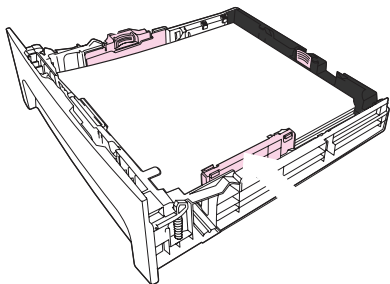

---

 **NOTE:** When you add new media, make sure that you remove all of the media from the input tray and straighten the stack of new media. Do not fan the media. This reduces jams by preventing multiple sheets of media from feeding through the product at one time.

---

## Configure trays

When using one of the trays for a specific size of paper, you can set the default size for the tray in HP ToolboxFX or from the control panel. In HP ToolboxFX, select **Paper handling**, and then select the size for the tray you want to set. When you select that size of paper for a print job in the print dialog, the product automatically selects that tray for printing.

To set the default paper size or type from the control panel, complete the following steps:

1. On the product control panel, press **Setup**.
2. Use the arrow buttons to select **System setup**, and then press **OK**.
3. Use the arrow keys to select **Paper setup**, and then press **OK**.
4. Use the arrow keys to select the tray to be configured, and then press **OK**.
5. Use the arrow keys to select either **Paper type** or **Paper size**, and then press **OK**.
6. Use the arrow keys to select a default type or size for the tray, and then press **OK**.

## Change tray selection

The product is set to automatically pull media from trays that contain media. The product always pulls media from tray 1 if you insert media into tray 1. If there is no media in tray 1, the product attempts to pull media from tray 3, if installed, and then from tray 2.

You can specify which tray you want to use by changing the tray selection. **Auto select**, **Tray 1**, **Tray 2**, and **Tray 3** are available settings. **Auto select** will pull media from the first available tray with the appropriate matching media loaded.

---

 **NOTE:** **Tray 3** is only available if a tray 3 is installed.

---

### Change the tray selection for the current job

1. On the product control panel, press **Tray Select**.
2. Use the arrow buttons to select the input tray that you want to use.
3. Press **Start Copy** to save the selection and immediately start the copy job, or press **OK** to save the selection without starting the job.

### Change the default tray selection

1. On the product control panel, press **Setup**.
2. Use the arrow buttons to select **Copy setup**, and then press **OK**.
3. Use the arrow buttons to select **Def. Tray Select**, and then press **OK**.
4. Use the arrow buttons to select a tray setting, and then press **OK**.

# Install memory DIMMs

## Information

The product comes with 64 MB of RAM and can be upgraded to 320 MB via the DIMM slot, which is accessible from the left side of the product.

## Install a memory DIMM

**CAUTION:** Handling a DIMM without wearing a grounded, antistatic device might damage the DIMM. Touch any metal part of the product or other grounded metal before touching the DIMM.

1. Use the power switch to turn off the product, and then unplug all of the cables and cords connected to the product.

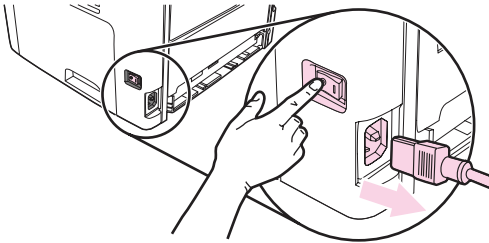

2. Open the DIMM door.

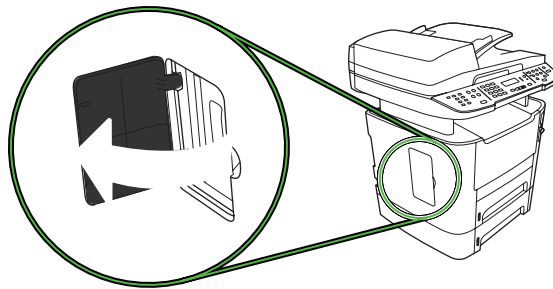

3. Remove the DIMM from the antistatic bag it came in, grasping the DIMM on the top edge.

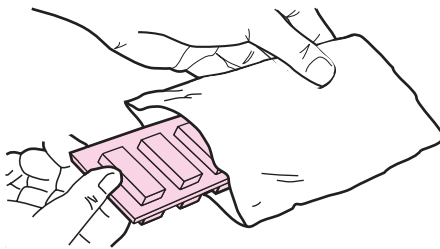

4. With the gold contacts facing upward, insert the DIMM in the DIMM seat and press the DIMM body in until the metal retaining pins click.

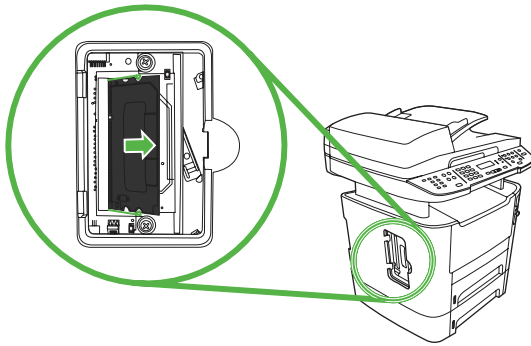
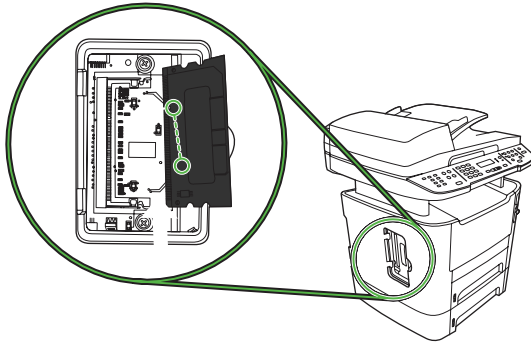

5. Close the DIMM door.

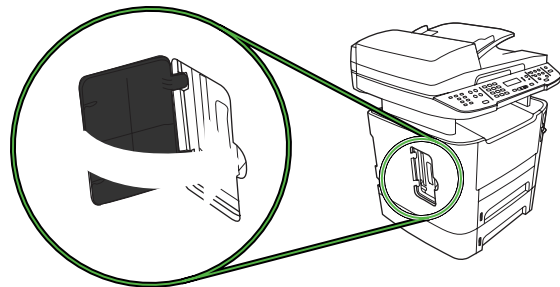

6. Reconnect all cables and cords, and then use the power switch to turn on the product.
7. Print a configuration page, and then verify that the Memory section shows the new memory amount. See [Product information pages and reports on page 237](#).



---

## 3 Maintenance

- Manage supplies
- Clean the product
- Manage the product

## Manage supplies

This section describes replacing the print cartridge, staple cassette, tray 2 pickup roller, and the tray 2 and optional tray 3 separation pad. For information about replacing the ADF pickup-roller assembly, see [Replace the ADF pickup-roller assembly on page 110](#).

Inspect any parts that wear when servicing the product. Replace them as needed, based on failure or wear rather than usage.

The following table lists approximate schedules for replacing consumables.

### Life expectancies of supplies and the product

| Item                         | Capacity  |
|------------------------------|---|
| HP LaserJet M2727 MFP Series | Recommended maximum of 3,000 pages per month                                    |
| Print cartridge              | 3,500 pages <sup>1</sup> (standard)<br>7,000 pages <sup>1</sup> (high-capacity) |
| Staple cassette              | 1,500 staples   |

<sup>1</sup> The estimated print cartridge life is based on using letter- or A4-sized media with an average of 5% toner coverage and a medium density setting. Print cartridge life can be extended by using draft-mode settings to conserve toner.

## Order supplies

 **NOTE:** To locate part numbers for supplies, see [Accessories and ordering information on page 247](#).

To order supplies, go to one of the following Web sites.

- North America: [www.hp.com/go/orders/supplies-na](http://www.hp.com/go/orders/supplies-na)
- Europe and Middle East: [www.hp.com/go/orders/supplies-emea](http://www.hp.com/go/orders/supplies-emea)
- Asia Pacific countries/regions: [www.hp.com/go/orders/supplies-ap](http://www.hp.com/go/orders/supplies-ap)
- Latin America: [www.hp.com/go/orders/supplies-la](http://www.hp.com/go/orders/supplies-la)



## Store print cartridges

Follow these guidelines for storing print cartridges:

- Do not remove the print cartridge from its package until you are ready to use it.

---

**CAUTION:** To prevent damage, do not expose the print cartridge to light for more than a few minutes.

---

- Make sure that you store print cartridges in accordance with the environmental operating and storage specifications in this manual. See [Environmental specifications on page 325](#).
- Store the print cartridges in a horizontal position.
- Store the print cartridges in a dark, dry location away from heat and magnetic sources.

## Replace and recycle supplies

Visit [www.hp.com/go/environment](http://www.hp.com/go/environment) or [www.hp.com/hpinfo/community/environment/productinfo/saftey](http://www.hp.com/hpinfo/community/environment/productinfo/saftey) for information about the following environmental topics:

- Product environmental profile sheet for this and many related HP products
- Hewlett Packard's commitment to the environment
- Hewlett-Packard's environmental management system
- Hewlett Packard's end-of-life product return and recycling program
- Material safety data sheets (MSDSs), which are also available at: [www.hp.com/go/msds](http://www.hp.com/go/msds), contain information about supplies that contain chemical substances, such as toner.

It's easy to return and recycle your empty HP LaserJet print cartridges—free of charge—with HP Planet Partners. HP is committed to providing inventive, high-quality products and services that are environmentally sound, from product design and manufacturing to distribution, operation, and recycling processes. We ensure that returned HP LaserJet print cartridges are recycled properly, processing them to recover valuable plastics and metals for new products and diverting millions of tons of waste from landfills. Because this cartridge is being recycled and used in new materials, it will not be returned to you. Empty HP LaserJet print cartridges are recycled responsibly when you participate in the HP Planet Partners program. Thank you for being environmentally responsible!

In many countries/regions, this product's printing supplies (for example, the print cartridge) can be returned to HP through the HP Printing Supplies Returns and Recycling Program. An easy-to-use and free take-back program is available in more than 35 countries/regions. Multi-lingual program information and instructions are included in every new HP LaserJet print cartridge and supplies package.

### HP Printing Supplies Returns and Recycling Program information

Since 1992, HP has offered HP LaserJet supplies return and recycling free of charge. In 2004, HP Planet Partners for LaserJet Supplies was available in 85% of the world market where HP LaserJet supplies are sold. Postage-paid and pre-addressed labels are included within the instruction guide in most HP LaserJet print cartridge boxes. Labels and bulk boxes are also available through the Web site [www.hp.com/go/recycle](http://www.hp.com/go/recycle).

Use the label to return empty, original HP LaserJet print cartridges only. Please do not use this label for non-HP cartridges, refilled or remanufactured cartridges, or warranty returns. Printing supplies or other objects that are inadvertently sent to the HP Planet Partners program cannot be returned.

More than 10 million HP LaserJet print cartridges were recycled globally in 2004 through the HP Planet Partners supplies recycling program. This record number represents 26 million pounds of print cartridge materials diverted from landfills. In 2004, HP recycled an average of 59% of the print cartridge by weight consisting primarily of plastic and metals. Plastics and metals are used to make new products such as HP products, plastic trays and spools. The remaining materials are disposed of in an environmentally responsible manner.

### **U.S. returns**

For a more environmentally responsible return of used cartridges and supplies, HP encourages the use of bulk returns. Simply bundle two or more cartridges together and use the single, pre-paid, pre-addressed UPS label that is supplied in the package. For more information in the U.S., call 1-800-340-2445 or visit the HP Web site at [www.hp.com/go/recycle](http://www.hp.com/go/recycle).

### **Non-U.S. returns**

Non-U.S. customers should visit the [www.hp.com/go/recycle](http://www.hp.com/go/recycle) Web site for further information regarding availability of the HP Printing Supplies Returns and Recycling Program.

### **Paper**

This product is capable of using recycled papers, when the paper meets the guidelines outlined in the *HP LaserJet Printer Family Print Media Guide*, which you can view on the Web at [www.hp.com/support/ljpaperguide](http://www.hp.com/support/ljpaperguide). This product is suitable for the use of recycled paper according to EN12281:2002.

### **Material restrictions**

This HP product contains a battery and contains mercury in the fluorescent lamp or scanner that might require special handling at end-of-life.

|                 |   |
|-----------------|---|
| Type:           | Lithium carbon monofluoride (solid button cell) |
| Weight:         | Approximately .1 gram                           |
| Location:       | On formatter PC board (one battery per product) |
| User removable: | No  |

## Replace print cartridge

1. Open the print-cartridge door.

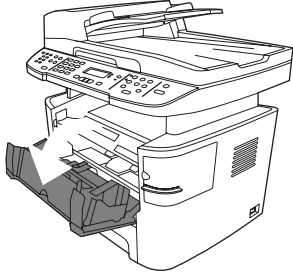

2. Grasp the handle on the print cartridge and then pull the cartridge straight out to remove it. See the recycling information inside the print cartridge box.

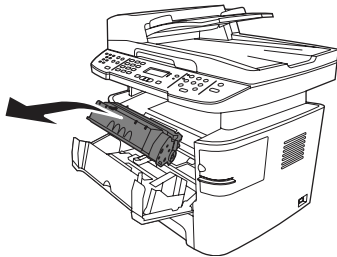

3. Remove the new print cartridge from its packaging, remove the orange cover from the print cartridge, and then pull the orange tab straight out to remove the sealing tape.

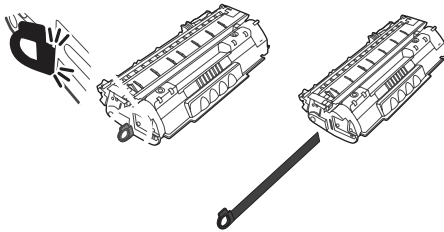

4. Insert the cartridge into the product until it is *firmly* in place.

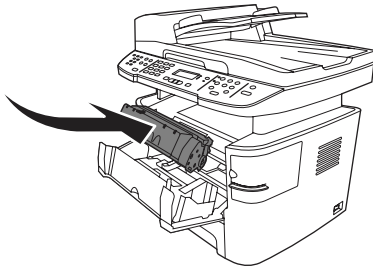

5. Close the print-cartridge door.

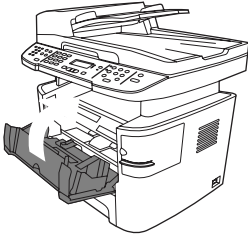

---

**CAUTION:** If toner gets on any clothing, wipe it off with a dry cloth and wash the clothing in cold water. *Hot water sets toner into the fabric.*

---

## Load staples

Each staple cassette holds 1,500 unformed staples.

1. Open the stapler door.

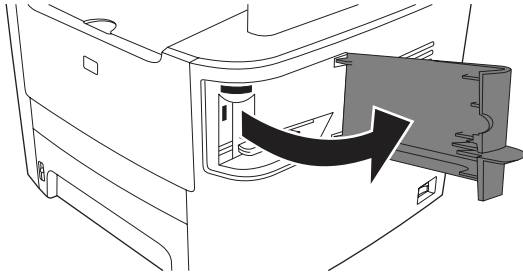

 **NOTE:** Opening the stapler door disables the stapler.

Instructions and replacement staples part numbers are listed on the stapler door.

2. If you are replacing a staple cassette (for example, if the staple cassette has run out of staples), remove the staple cassette from the product.

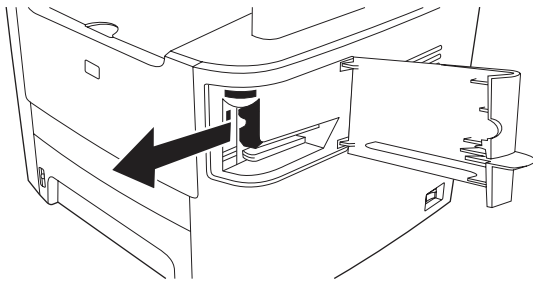

3. Insert a new staple cassette into the opening inside the stapler door.

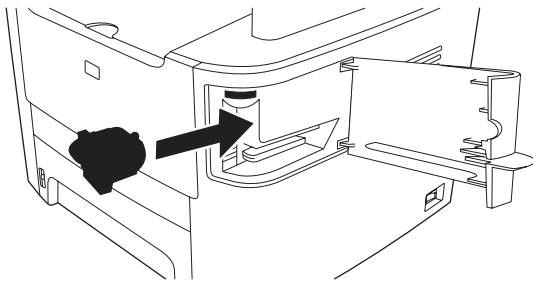

4. Close the stapler door.

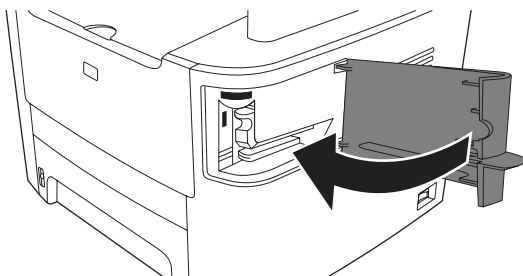

## Replace the tray 2 pickup roller

---

**CAUTION:** Failure to correctly complete this procedure might cause damage to the product.

---

1. Perform the following tasks before beginning this procedure:
  - Turn off the product and unplug the power cord from the electrical outlet.
  - Open the print-cartridge door and remove the print cartridge.
  - Remove the tray 2 cassette.
  - Lift the product off of tray 3, if that tray is installed.
2. Place the product on its back on the work surface, with the front facing up.

---

**WARNING!** When you move the product into this position, the scanner cover can open suddenly and be damaged. You *must* support the scanner cover to keep it from opening.

---

**Figure 3-1** Replace the tray 2 pickup roller (1 of 7)

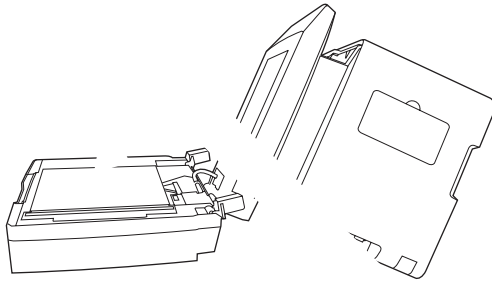

3. Reach into the area that you exposed when you removed tray 2. Pull the white tabs outward, and then rotate the roller-retaining collars up.

 **TIP:** Push down on the green tab to release and lower the duplex assembly to expose more of the roller.

**Figure 3-2** Replace the tray 2 pickup roller (2 of 7)

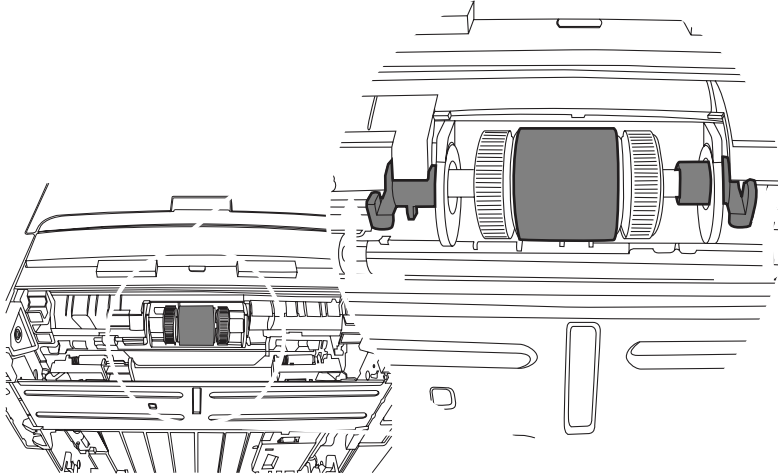

4. With the tab on the collar aligned with the slot in the plastic bracket, slide the collar to the right. Leave the collar in this position for the remainder of this procedure.

**Figure 3-3** Replace the tray 2 pickup roller (3 of 7)

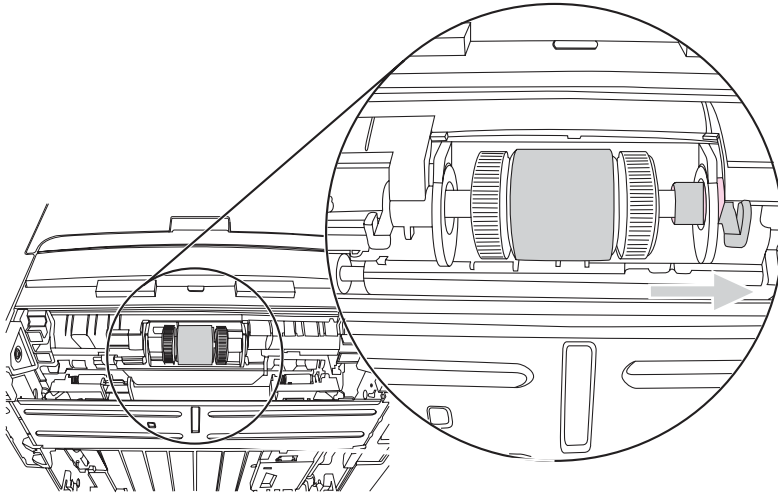

5. Remove the pickup roller.

**Figure 3-4** Replace the tray 2 pickup roller (4 of 7)

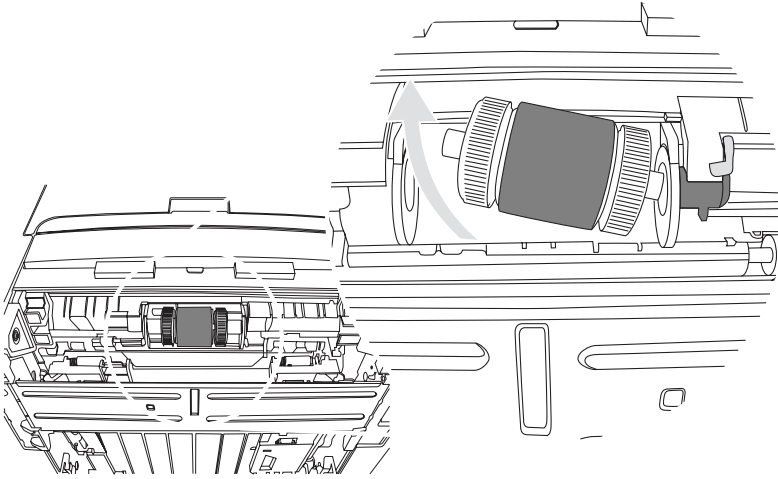

6. Insert the left side of the replacement pickup-roller shaft into the left slot (callout 1), and then insert the right side shaft (the side with the notch) into the right slot (callout 2).

**Figure 3-5** Replace the tray 2 pickup roller (5 of 7)

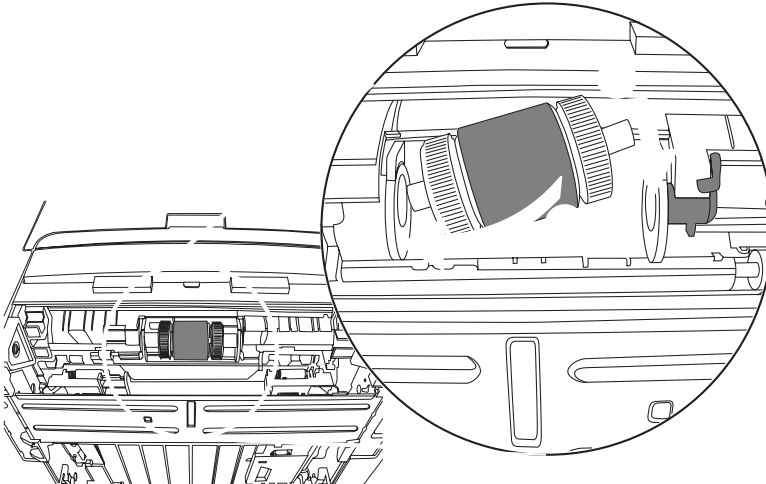

7. Rotate the roller shaft until the notch engages with the drive shaft and clicks into place.



8. Place the left retaining collar over the end of the roller shaft, align the tab on the collar with the slot in the plastic bracket, and then slide the collar toward the pickup roller.

**Figure 3-6** Replace the tray 2 pickup roller (6 of 7)

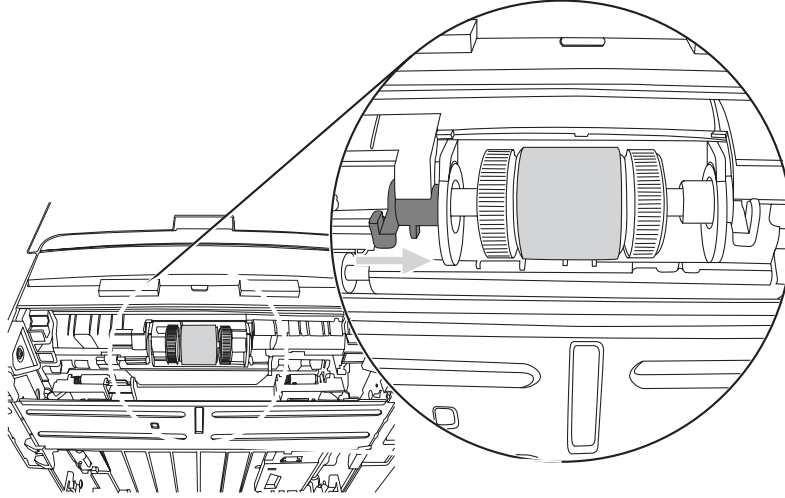

9. With the tab on the right collar aligned with the slot on the plastic bracket, slide the collar towards the pickup roller. Rotate the right and left retaining collars down into the locked position.

**Figure 3-7** Replace the tray 2 pickup roller (7 of 7)

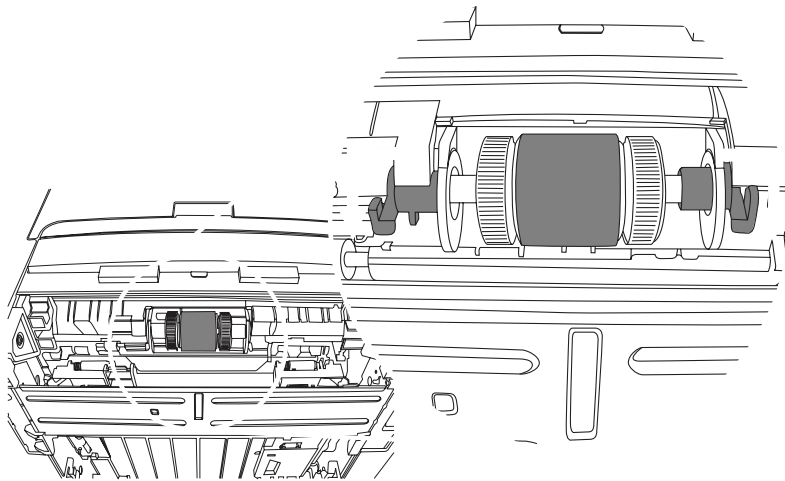

10. Push up on the duplex assembly until it locks into place. Place the product upright on the work surface with the top of the product facing up.

---

**WARNING!** When you move the product into this position, the scanner cover can open suddenly and be damaged. You *must* support the scanner cover to keep it from opening.

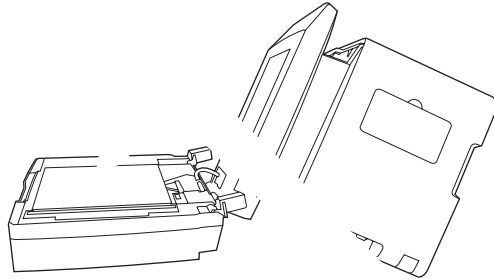

- 
11. Perform the following tasks after completing this procedure.
- Replace the product on tray 3, if that tray was installed.
  - Replace the tray 2 cassette.
  - Open the print-cartridge door and install the print cartridge.
  - Plug the power cord into an electrical outlet, and turn on the product.

## Replace the tray 2 and optional tray 3 separation pad

1. Remove tray 2 or tray 3.

**Figure 3-8** Replace the tray 2 or tray 3 separation pad (1 of 6)

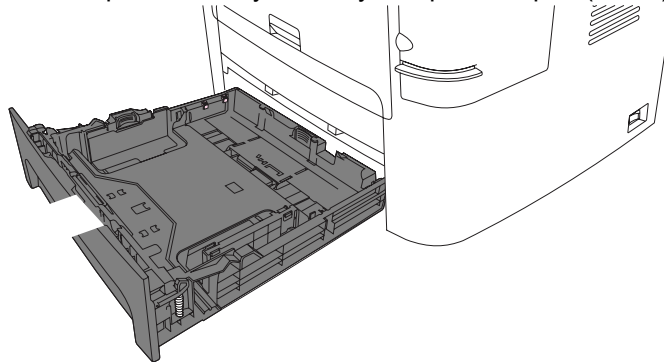

2. Locate the separation pad.

**Figure 3-9** Replace the tray 2 or tray 3 separation pad (2 of 6)

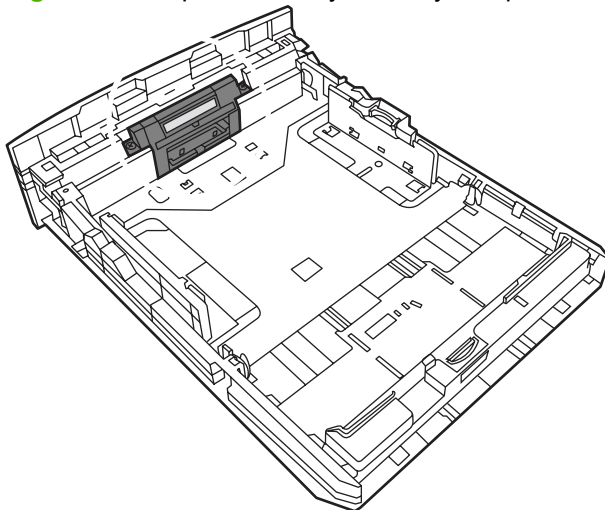

3. Remove two screws.

**Figure 3-10** Replace the tray 2 or tray 3 separation pad (3 of 6)

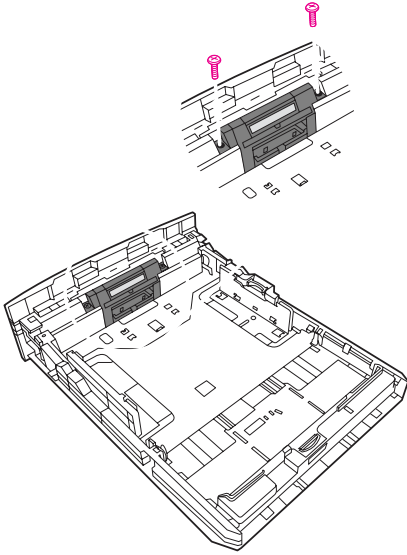

4. Remove the separation pad.

**CAUTION:** Before you remove the separation pad, take note of how it is positioned in the tray.

**Figure 3-11** Replace the tray 2 or tray 3 separation pad (4 of 6)

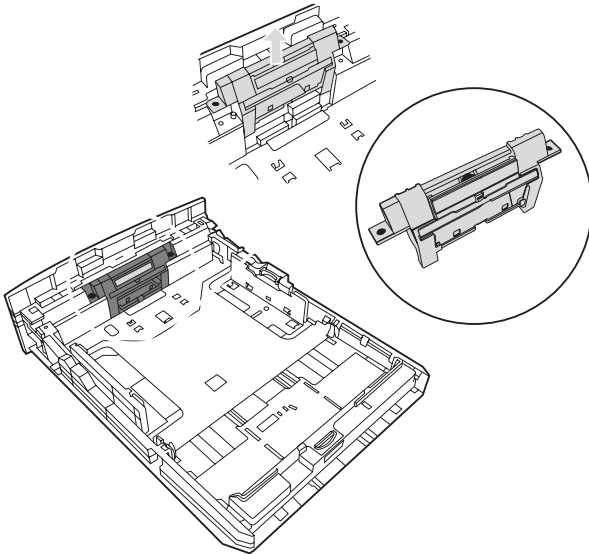

5. Install the replacement separation pad.

**Figure 3-12** Replace the tray 2 or tray 3 separation pad (5 of 6)

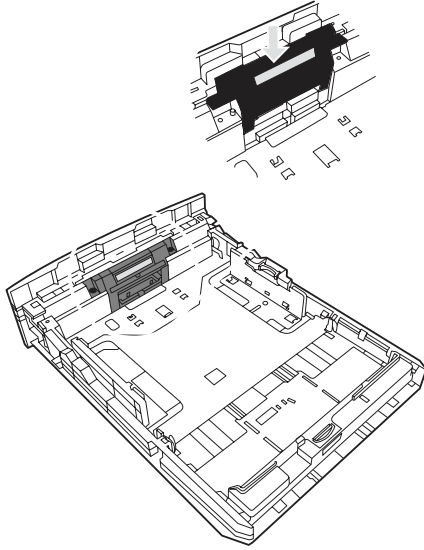

6. Replace the two screws, and then return the tray to the product.

**Figure 3-13** Replace the tray 2 or tray 3 separation pad (6 of 6)

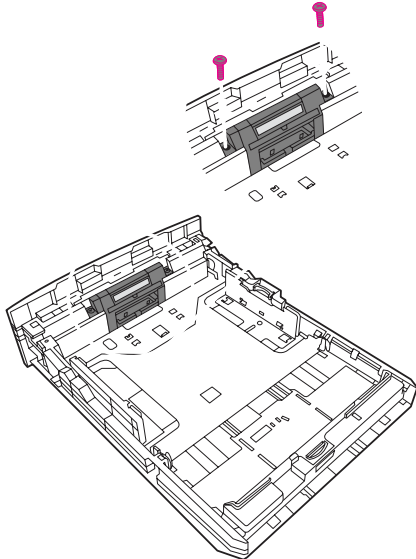

## HP policy on non-HP supplies

Hewlett-Packard Company cannot recommend the use of non-HP supplies, either new or remanufactured. Because they are not HP products, HP cannot influence their design or control their quality. Service or repairs required as a result of using a non-HP supply will *not* be covered under the warranty.

When you insert a supply into the product, the product will inform you if the supply is not a genuine HP supply. If you insert a genuine HP supply that has reached the low state from another HP device, the product identifies the supply as non-HP. Simply return the supply to the original device to reactivate the HP features and functionality.

## Reset the product for non-HP supplies

When you install a non-HP print cartridge, **Unauthorized** appears on the control-panel display. In order to print with this supply, you must press **OK** when you install this non-HP supply.

---

**CAUTION:** The product will *not* stop printing when this type of supply is empty. Damage to the product could occur if the product prints with an empty non-HP print cartridge. See [Hewlett-Packard limited warranty statement on page 319](#) and [Print cartridge limited warranty statement on page 321](#).

---

## HP fraud hotline

Call the HP fraud hotline if the product or HP ToolboxFX indicates that the print cartridge is not an HP print cartridge and you think that it is genuine. HP will help determine if the product is genuine and take steps to resolve the problem.

The print cartridge might not be a genuine HP product if you notice the following issues:

- You are experiencing a large number of problems with the print cartridge.
- The print cartridge does not look like it usually does (for example, the pull tab or the box is different).

*In the United States*, call toll-free: 1-877-219-3183.

*Outside the United States*, you can call collect. Dial the operator and ask to place a collect call to this telephone number: 1-770-263-4745. If you do not speak English, a representative at the HP fraud hotline who speaks your language will assist you. Or, if someone who speaks your language is not available, a language line interpreter will connect approximately one minute after the beginning of the call. The language line interpreter is a service that will translate between you and the representative for the HP fraud hotline.

# Clean the product

## Clean the exterior

Use a soft, damp, lint-free cloth to wipe dust, smudges, and stains off of the exterior of the product.

## Clean the flatbed scanner glass

Dirty glass, from fingerprints, smudges, hair, and so on, slows down performance and affects the accuracy of special features such as fit-to-page and copy.

---

 **NOTE:** If streaks or other defects appear only on copies produced from the ADF, clean the ADF scanner glass (step 3). It is not necessary to clean the flatbed scanner glass.

---

1. Turn off the product, unplug the power cord from the electrical outlet, and raise the scanner cover.
2. Clean the glass by using a soft cloth or sponge that has been moistened with nonabrasive glass cleaner.

---

 **CAUTION:** Do not use abrasives, acetone, benzene, ammonia, ethyl alcohol, or carbon tetrachloride on any part of the product, as they can damage the product. Do not place liquids directly on the glass. They might seep under it and damage the product.

---

**Figure 3-14** Clean the scanner glass (1 of 2)

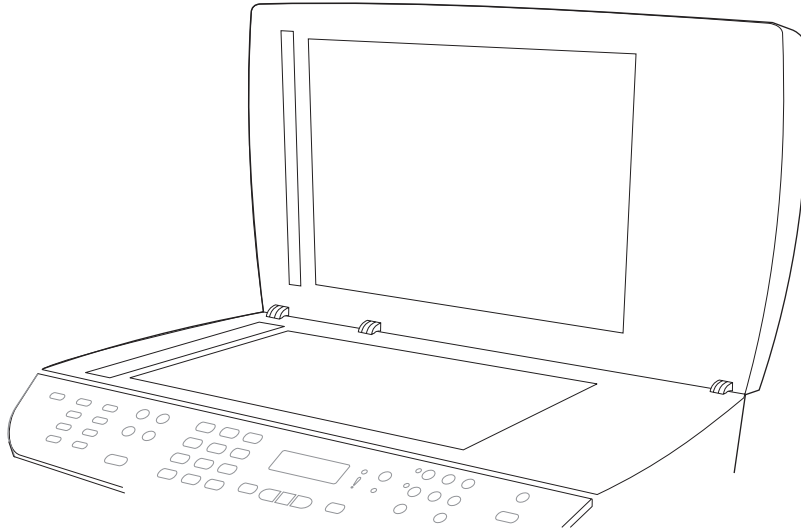

3. Clean the ADF scanner glass by using a soft cloth or sponge that has been moistened with nonabrasive glass cleaner.

**Figure 3-15** Clean the scanner glass (2 of 2)

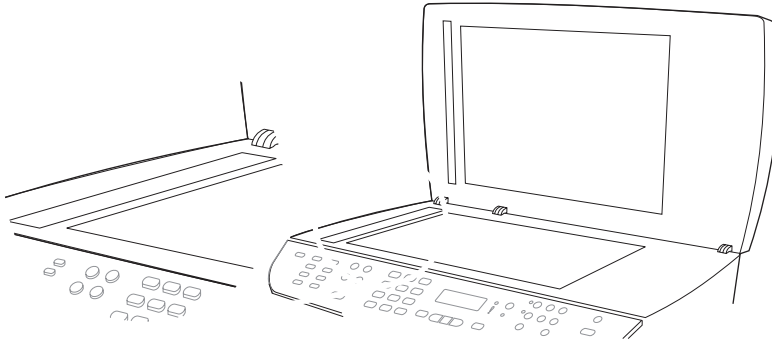



## Clean the scanner-cover backing

1. Turn off the product, unplug the power cord from the electrical outlet, and raise the scanner cover.
2. Clean the white scanner-cover backing by using a soft cloth or sponge that has been moistened with mild soap and warm water. Also, clean the ADF scanner glass (callout 1) next to the flatbed scanner glass.

**Figure 3-16** Clean the scanner-cover backing

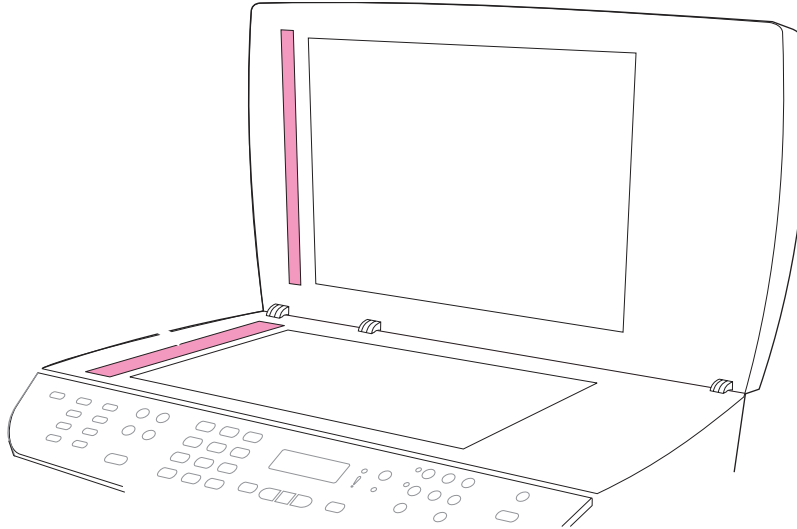

3. Wash the backing gently to loosen debris; do not scrub the backing.
4. Dry the backing by using a chamois or soft cloth.

---

**CAUTION:** Do not use paper-based wipes because they might scratch the backing.

---

5. If this does not clean the backing well enough, repeat the previous steps and use isopropyl alcohol to dampen the cloth or sponge, and then wipe the backing thoroughly with a damp cloth to remove any residual alcohol.

## Clean the tray 2 pickup roller

1. Perform the removal steps from [Replace the tray 2 pickup roller on page 40](#).
2. Gently wipe the roller with a lint-free cloth moistened with water.

**Figure 3-17** Clean the tray 2 pickup roller (1 of 6)

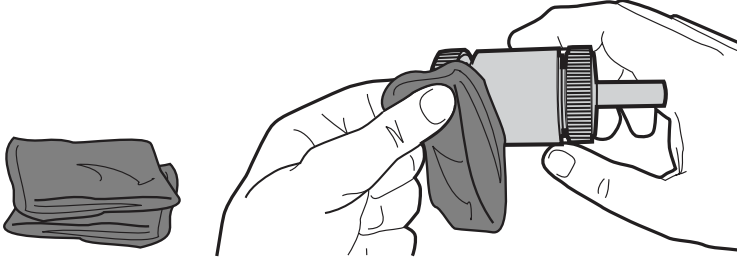

3. Use a dry lint-free cloth to wipe the roller and remove loosened dirt.

**Figure 3-18** Clean the tray 2 pickup roller (2 of 6)

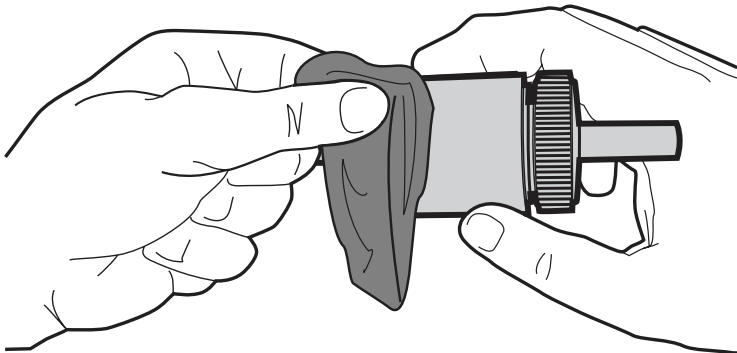

4. Allow the roller to dry completely before you reinstall it.

**Figure 3-19** Clean the tray 2 pickup roller (3 of 6)

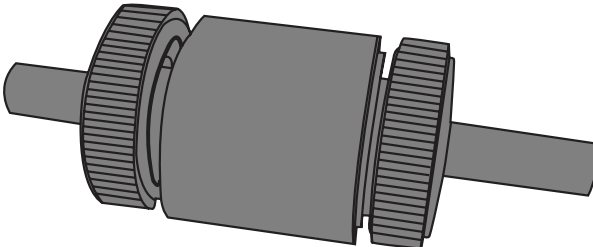

5. Insert the left side of the pickup-roller shaft into the left slot (callout 1), and then insert the right side of the shaft (the side with the notch) into the right slot (callout 2).

**Figure 3-20** Clean the tray 2 pickup roller (4 of 6)

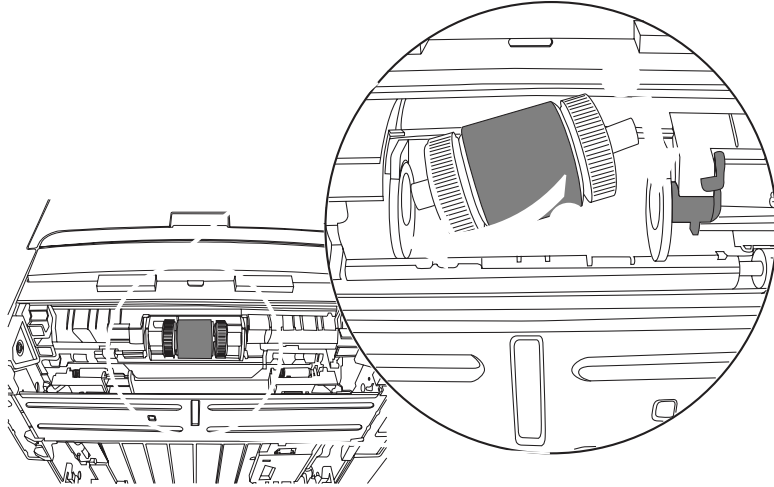

6. Rotate the roller shaft until the notch engages with the drive shaft and clicks into place.
7. Place the left retaining collar over the end of the roller shaft, align the tab on the collar with the slot in the plastic bracket, and then slide the collar toward the pickup roller.

**Figure 3-21** Clean the tray 2 pickup roller (5 of 6)

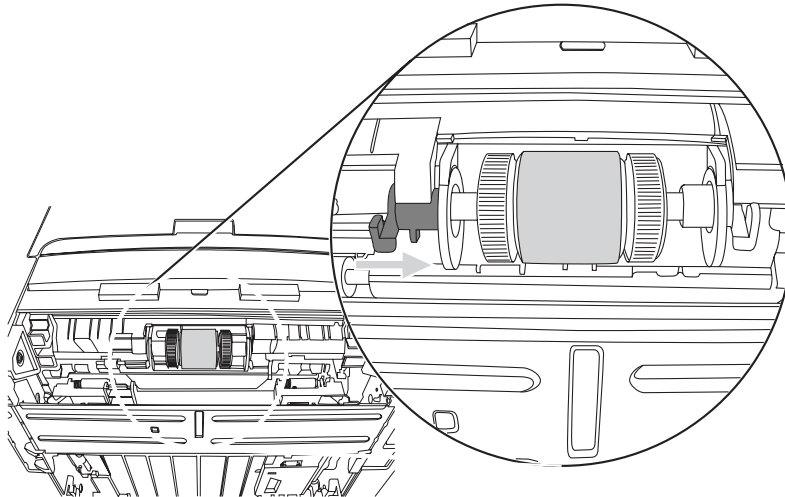

8. With the tab on the right collar aligned with the slot on the plastic bracket, slide the collar towards the pickup roller. Rotate the right and left retaining collars down into the locked position.

**Figure 3-22** Clean the tray 2 pickup roller (6 of 6)

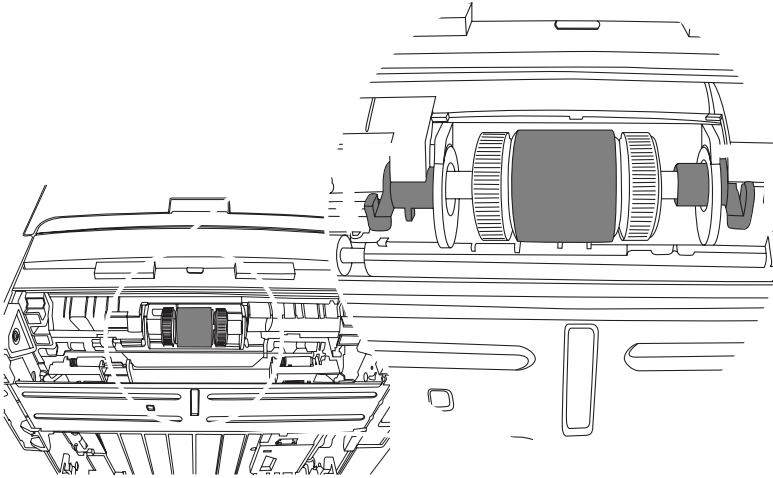

9. Push up on the duplex assembly until it locks into place, and then place the product upright on the work surface with the top of the product facing up.

**WARNING!** When you move the product into this position, the scanner cover can open suddenly and be damaged. You *must* support the scanner cover to keep it from opening.

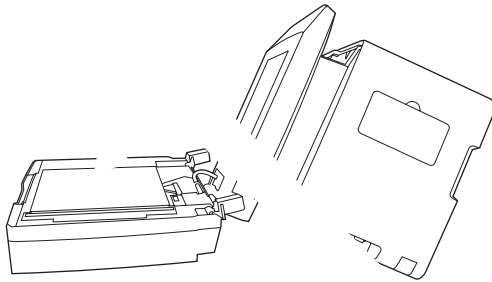

10. Perform the following tasks after completing this procedure.
  - Replace the product on tray 3, if that tray was installed.
  - Replace the tray 2 cassette.
  - Open the print-cartridge door and install the print cartridge.
  - Plug the power cord into an electrical outlet, and turn on the product.

## Clean the ADF pickup-roller assembly

1. Turn off the product and unplug the power cord.

**Figure 3-23** Clean the ADF pickup-roller assembly (1 of 5)

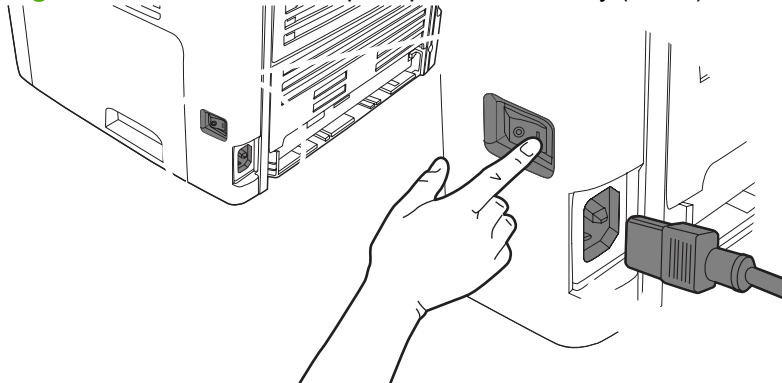

2. Open the ADF cover.

**Figure 3-24** Clean the ADF pickup-roller assembly (2 of 5)

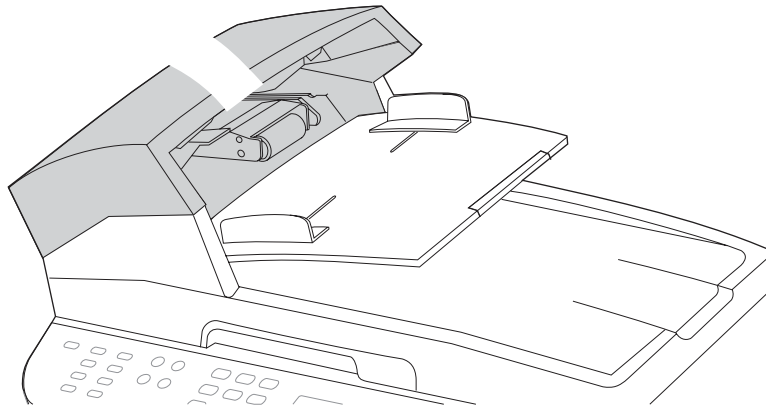

3. Rotate the assembly upward. Wipe it clean and rotate the rollers until the assembly is clean.

**Figure 3-25** Clean the ADF pickup-roller assembly (3 of 5)

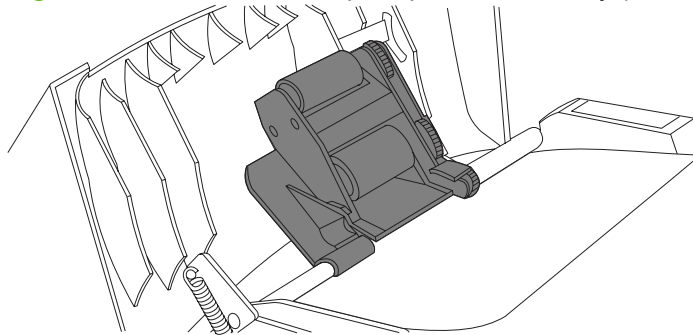

4. Lower the green lever and the roller assembly and close the ADF cover.

**Figure 3-26** Clean the ADF pickup-roller assembly (4 of 5)

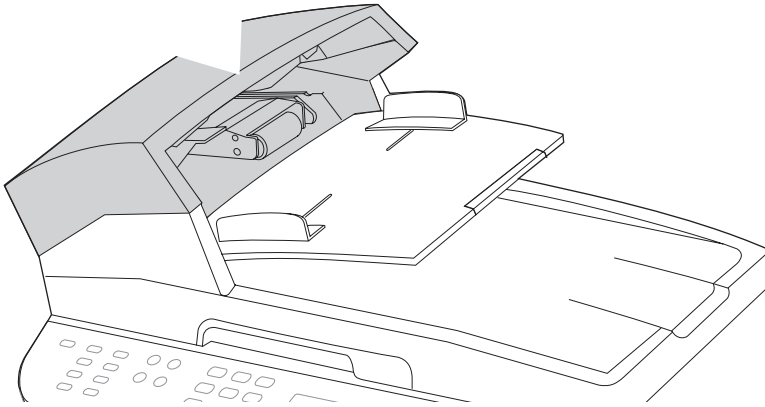

5. Plug in the product, and then turn it on.

**Figure 3-27** Clean the ADF pickup-roller assembly (5 of 5)

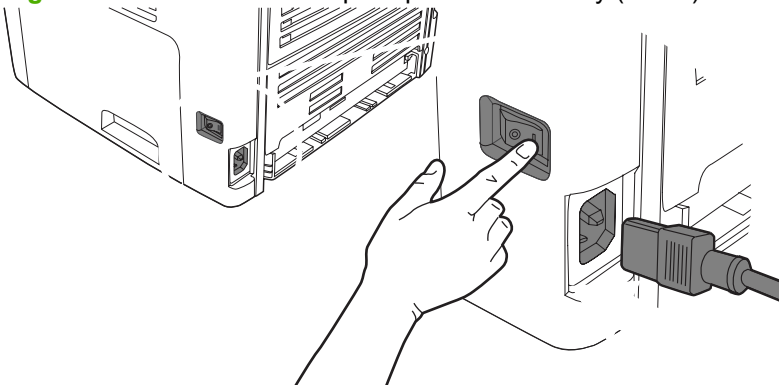

## Clean the paper path

During the printing process, paper, toner, and dust particles can accumulate inside the product. Over time, this buildup can cause print-quality problems such as toner specks or smearing. This product has a cleaning mode that can correct and prevent these types of problems.

Specks

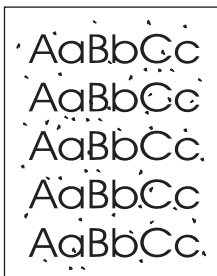

Smearing

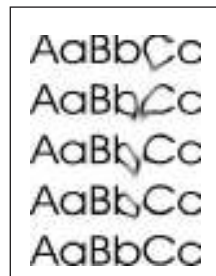

## Clean the paper path from HP ToolboxFX

Use HP ToolboxFX to clean the paper path. This is the recommended cleaning method. If you do not have access to HP ToolboxFX, use the method in [Clean the paper path from the product control panel on page 57](#).

1. Make sure that the product is turned on and in the Ready state, and that media is loaded in tray 1 or tray 2.
2. Open HP ToolboxFX, click the product, and then click the **System Settings** tab.
3. Click the **Service** tab, and then click **Start**.

A page feeds through the product slowly. Discard the page when the process is completed.

## Clean the paper path from the product control panel

If you do not have access to HP ToolboxFX, you can print and use a cleaning page from the product control panel.

1. Press **Setup**.
2. Use the arrow buttons to select the **Service** menu, and then press **OK**.
3. Use the arrow buttons to select **Cleaning mode**, and then press **OK**.
4. Load plain letter or A4 paper when you are prompted.
5. Press **OK** again to confirm and begin the cleaning process.

A page feeds through the product slowly. Discard the page when the process is completed.

# Manage the product

## HP ToolboxFX

The HP ToolboxFX is a Web-based program that you can use to complete the following tasks:

- Check the product status.
- Configure the product settings.
- View problem-solving information.
- View online documentation.

You can view the HP ToolboxFX when the product is directly connected to your computer or when it is connected to the network. You must perform a typical software installation to use HP ToolboxFX.

 **NOTE:** The HP ToolboxFX is not supported for Windows 98 SE or Macintosh operating systems. To use the HP ToolboxFX, the TCP/IP protocol must be installed on the computer. You do not have to have Internet access to open and use the HP ToolboxFX.

---

## View the HP ToolboxFX

Open the HP ToolboxFX in one of these ways:

- In the Windows system tray or on the desktop, double-click the HP ToolboxFX icon.
- On the Windows **Start** menu, click **Programs** (or **All Programs** in Windows XP), click **HP**, click **HP LaserJet M2727**, and then click **HP ToolboxFX**.

The HP ToolboxFX software contains the following tabs, and the information about each tab is on the specified page:

- [Status on page 58](#)
- [Alerts on page 59](#)
- [Fax on page 59](#)
- [Help \(Documentation\) on page 62](#)
- [System settings on page 63](#)
- [Print settings on page 65](#)
- [Network settings on page 66](#)

## Status

The HP ToolboxFX **Status** tab contains links to the following main pages:

- **Device Status.** View product status information. This page indicates product conditions such as a jam or an empty tray. After you correct a problem with the product, click **Refresh Status** to update the product status.
- **Supplies Status.** View detailed supplies status, such as the estimated percentage of toner remaining in the print cartridge and the number of pages that have been printed with the current print cartridge. This page also has links to order supplies and to find recycling information.



- **Device configuration.** View a detailed description of the current product configuration, including the amount of memory that is installed and whether optional trays are installed.
- **Network configuration.** View a detailed description of the current network configuration, including the IP address and network status.
- **Print Info Pages.** Print the Configuration page and various other information pages that are available for the product, such as the Supplies Status page and the Demo page.
- **Event Log.** View a history of product errors. The most recent error is at the top of the list.

## Event log

The Event log is a four-column table where the product events are logged for your reference. The log contains codes that correspond to the error messages that appear on the product control-panel display. The number in the Page Count column specifies the total number of pages that the product had printed when the error occurred. The Event log also contains a brief description of the error. For more information about error messages, see [Control-panel messages on page 169](#).

## Alerts

The HP ToolboxFX **Alerts** tab contains links to the following main pages:

- **Set up Status Alerts.** Set up the product to send pop-up alerts for certain events, such as low toner levels.
- **Set up E-mail Alerts.** Set up the product to send e-mail alert messages for certain events, such as low toner levels.

### Set up status alerts

Use HP ToolboxFX to set up the product so that it issues pop-up alerts when certain events occur. Events that trigger alerts include jams, low levels of toner in HP print cartridges, non-HP print cartridge in use, empty input trays, and specific error messages.

Select the pop-up format, the tray icon format, or both for the alerts. The pop-up alerts only appear when the product is printing from the computer on which you set up the alerts.

---

 **NOTE:** You must click **Apply** before changes take effect.

---

### Set up e-mail alerts

Use HP ToolboxFX to configure up to two e-mail addresses to receive alerts when certain events occur. You can specify different events for each e-mail address. Specify the information for the e-mail server that will send out the e-mail alert messages for the product.

---

 **NOTE:** You must click **Apply** before changes take effect.

---

## Fax

Use the HP ToolboxFX **Fax** tab to perform fax tasks from the computer. The **Fax** tab contains links to the following main pages:

- **Fax Tasks.** Perform such tasks as sending a fax or clearing the fax memory, or set the fax receive mode.
- **Fax Phone Book.** Add, edit, or delete entries in the product phone book.

- **Fax Send Log.** View all of the recent faxes that have been sent from the product.
- **Fax Receive log.** View all of the recent faxes that have been received by the product.
- **Fax Dat Properties.** Manage the space used to store faxes on a computer. These settings apply only if you have chosen to send or receive faxes remotely from the computer.

## Fax tasks

The following three options are available when receiving a fax:

- **Print the fax.** You can select an option to have a message appear on a computer to notify you when a fax is printed.
- **Receive the fax on your computer.** You can select an option to have a message appear on a computer to notify you when a fax arrives. If the fax machine is connected to multiple computers, only one computer can be designated to receive faxes.
- **Forward the fax to another fax machine.**

For more information about fax tasks, see [Fax on page 59](#).

---

 **NOTE:** You must click **Apply** before changes take effect.

---

## Fax phone book

Use the HP ToolboxFX Fax phone book to add and remove individuals or groups on a speed-dial list, import phone books from a variety of sources, and update and maintain a contact list.

- To add an individual contact to a speed-dial list:
  1. Select the check box next to the speed dial number that you want to specify.
  2. Type the contact name in the **Contact Name** window.
  3. Type the fax number in the **Fax number** window.
  4. Click **Add/Edit**.
- To add a group of contacts to a speed-dial list:
  1. Select the check box next to the speed-dial number that you want to specify.
  2. Click **New/Edit Group**.
  3. Double-click a contact name from the list on the left to move it to the group list on the right, or select a name on the left and then click the appropriate arrow to move it to the group list on the right. You can also use these two methods to move names from right to left.
  4. When you have created a group, type a name in the **Group name** window, and then click **OK**.
- To edit an existing individual speed-dial entry:
  1. Click anywhere on the row that contains the contact name to select it.
  2. Type changes in the appropriate windows, and then click **Add/Edit**.

You can also make changes directly in the phone book directory list by clicking the entry and typing your changes. Make sure that you do not have a check mark in the **Select** column.

- To edit an existing group speed-dial entry:
    1. Click anywhere on the row containing the group name to select it, and then click **New/Edit Group**.
    2. Make any required changes, and then click **OK**.
 

You can make changes to the name of the group directly in the phone book directory list by clicking the entry and typing your changes. Make sure that you do not have a check mark in the **Select** column.
  - To delete an entry from the speed-dial list: Select the item and then click **Delete**.
  - To move speed-dial entries:
    1. Select the entry and then click **Move**, or you can select **Move** and then specify the entry in the dialog box.
    2. Select **Next empty row**, or specify the number of the row where you want to move the entry.
- 
-  **NOTE:** If you specify a row that is occupied, the new entry will overwrite the existing entry.
- 
- To import contacts from a phone book that exists in Lotus Notes, Outlook, or Outlook Express:
    1. Click **Import Phone Book**.
    2. Select the appropriate software program, navigate to the appropriate file, and then click **OK**.
 

You can also select individual entries from the phone book instead of importing the entire phone book.
  - To select all of the entries in your speed-dial list: Click the **Select** column heading.

In addition to numerical digits, the following are valid characters for fax numbers:

- (
- )
- +
- -
- \*
- #
- R
- W
- .
- ,
- <space>

---

 **NOTE:** You must click **Apply** before changes take effect.

---

## Fax send log

The HP ToolboxFX Fax send log lists all recently sent faxes and information about them, including the date and time sent, job number, fax number, page count, and the results.

When you send a fax from a computer that is connected to the product, the fax contains a **View** link. Click this link to open a new page that provides information about the fax.

Click any column heading in the Fax send log to re-sort the information in that column in ascending or descending order.

The Results column shows the status of the fax. If the fax attempt was unsuccessful, this column provides a description of why the fax was not sent.

---

 **NOTE:** You must click **Apply** before changes take effect.

---

For more information about faxes, see [Fax on page 59](#).

## Fax receive log

The HP ToolboxFX Fax receive log provides a list of all recently received faxes and information about them, including the date and time received, job number, fax number, page count, results, and an abbreviated fax image.

When you receive a fax on a computer that is connected to the product, the fax contains a **View** link. Click this link to open a new page that provides information about the fax.

Click on any column heading in the Fax receive log to re-sort the information in that column in ascending or descending order.

The Results column provides the status of the fax. If the fax attempt was unsuccessful, this column provides a description of why the fax was not received.

---

 **NOTE:** You must click **Apply** before changes take effect.

---

## Help (Documentation)

The HP ToolboxFX **Documentation** tab contains links to the following main pages:

- **Troubleshooting**
- **How do I?** View the How Do I? Help for help with specific tasks.
- **Animated Demonstrations**
- **User Guide.** View information about the product usage, warranty, specifications, and support. The user guide is available in both HTML and PDF format.
- **Install Notes.** View important information about the product that is not available in the user guide. The late-breaking Install Notes contain last-minute information about the product (in English only).

## System settings

The HP ToolboxFX **System Settings** tab contains links to the following main pages:

- **Device information.** View information about the product, such as the product description and a contact person.
- **Paper handling.** Change the product paper-handling settings, such as default paper size and default paper type.
- **Print quality.** Change the product print-quality settings.
- **Paper types.** Change the product mode settings for a each media type, such as letterhead, prepunched, or glossy paper.
- **System setup.** Change the product system settings, such as product language and jam recovery.
- **Service.** Gain access to various procedures that help you maintain the product.
- **Device polling.** Change the product polling settings, which determine how often HP ToolboxFX collects data from the product.
- **Save/restore settings.** Save the current settings for the product to a file on your computer. Use this file to load the same settings onto another product or to restore these settings to this product at a later time.

## Device information

The HP ToolboxFX Device information page stores data about your product for future reference. The information that you type in these fields appears on the Configuration page. You can type any character in each of these fields.



---

**NOTE:** You must click **Apply** before changes take effect.

---

## Paper handling

Use the HP ToolboxFX paper-handling options to configure your default settings. These are the same options that are available on the **Paper Handling** and **Printing** menus on the control panel.

You must set the asset number. The asset number is not set at the factory. This number is stored in the product for identification purposes.

Three options are available for handling print jobs when the product is out of media:

- Select **Wait for paper to be loaded**.
- Select **Cancel** from the **Paper out action** drop-down list to cancel the print job.
- Select **Override** from the **Paper out time** drop-down list to send the print job to another paper tray.

The **Paper out time** field specifies how long the product waits before acting on your selections. You can specify from 0 to 3600 seconds.

---

 **NOTE:** You must click **Apply** before changes take effect.

---

## Print quality

Use the HP ToolboxFX print-quality options to improve the appearance of your print jobs. These are the same options that are available on the **Print Quality** menu on the control panel.

The four options provided for controlling print quality are resolution, REt (Resolution Enhancement technology), print density, and Economode.

- **Resolution.** Select 600 resolution for average print jobs and Fast Res 1200 for higher-quality print jobs. Select ProRes 1200 for the highest-quality print job, but a longer printing time.
- **REt.** You can turn on REt, which HP provides for improved print quality.
- **Print density.** For increased print density, select a higher number. For decreased print density, select a lower number.
- **Economode.** Turn Economode on when you are printing average print jobs. Economode reduces print quality, but increases the life of your print cartridge. To increase print quality, turn Economode off. HP does not recommend full-time use of Economode.

---

 **NOTE:** You must click **Apply** before changes take effect.

---

## Paper types

Use the HP ToolboxFX paper-types options to configure print modes that correspond to the various media types. When you select **Restore Modes**, all of the modes are reset to the factory settings.

---

 **NOTE:** You must click **Apply** before changes take effect.

---

## System setup

Use the HP ToolboxFX system-settings options to configure the settings for printing, faxing, copying, and scanning. These are the same options that are available on the **System Settings** menu on the control panel.

---

 **NOTE:** You must click **Apply** before changes take effect.

---

## Service

During the printing process, paper, toner, and dust particles can accumulate inside the product. Over time, this buildup can cause print-quality problems, such as toner specks or smearing. HP ToolboxFX provides an easy method for cleaning the paper path. For more information, see [Clean the paper path on page 56](#).

## Device Polling

You can turn off HP ToolboxFX device polling to reduce network traffic, but you will also disable some HP ToolboxFX features: pop-up alerts, fax log updates, the ability to receive faxes to this computer, and scanning using the **Scan To** button.

To turn device polling on, do *both* of the following tasks:

- Clear **Turn off device polling** in HP ToolboxFX.
- Turn on one of the disabled device-polling features in HP ToolboxFX.

---

 **NOTE:** You must click **Apply** before changes take effect.

---

## Print settings

The HP ToolboxFX **Print Settings** tab contains links to the following main pages:

- **Printing.** Change the default product print settings, such as number of copies and paper orientation.
- **PCL5e.** View and change the PCL5e settings.
- **PostScript.** View and change the PS settings.

## Printing

Use the HP ToolboxFX printing-settings options to configure the settings for all print functions. These are the same options that are available on the **Print Settings** menu on the control panel.

---

 **NOTE:** You must click **Apply** before changes take effect.

---

## PCL 5e

Use the PCL5e options to configure the settings when you are using the PCL5e print personality. These are the same options that are available on the **PCL5e** menu on the control panel.

---

 **NOTE:** You must click **Apply** before changes take effect.

---

## PostScript

Use the PostScript option when you are using the PostScript print personality. When the **Print PostScript error** option is turned on, the PostScript error page automatically prints when PostScript errors occur.

---

 **NOTE:** You must click **Apply** before changes take effect.

---

## Network settings

The network administrator can use the HP ToolboxFX **Network Settings** tab to control the network-related settings for the product when it is connected to an IP-based network.

## Embedded Web server

This product is equipped with an embedded Web server (EWS), which provides access to information about product and network activities. A Web server provides an environment in which Web programs can run, much in the same way that an operating system, such as Windows, provides an environment for programs to run on a computer. The output from these programs can then be displayed by a Web browser, such as Microsoft Internet Explorer, Safari, or Netscape Navigator.

An “embedded” Web server resides on a hardware device (such as an HP LaserJet product) or in firmware, rather than as software that is loaded on a network server.

The advantage of an EWS is that it provides an interface to the product that anyone with a network-connected product and computer can use. There is no special software to install or configure, but you must have a supported Web browser on the computer. To gain access to the EWS, type the IP address for the product in the address line of the browser. (To find the IP address, print a configuration page. For more information about printing a configuration page, see [Product information pages and reports on page 237.](#))

---

 **NOTE:** For Macintosh operating systems, you can use the EWS over a USB connection after installing the Macintosh software included with the product.

---

## Features

The EWS allows you to view product and network status and manage printing functions from a computer. With the EWS, you can complete the following tasks:

- View product status information.
- Determine the remaining life on all supplies and order new ones.
- View and change part of the product configuration.
- View and print some internal pages.
- Select the language in which to display the EWS pages.



- View and change network configuration.
- Set, change, or clear the product security password.

---

 **NOTE:** Changing network settings in the EWS might disable some product software or features.

---

## Secure the embedded Web server

Use the EWS to set a password.

1. Open the EWS, and then click the **System** tab.
2. Click **Password**.
3. In the **Password** box, type the password you want to set, and then in the **Confirm password** box, type the same password again to confirm your choice.
4. Click **Apply** to save the password.

## Macintosh Configure Device (Mac OS X v10.3, v10.4, and later)

Macintosh Configure Device is a Web-based program that provides access to information about the product (for example, information about supplies status and product settings). Use Macintosh Configure Device to monitor and manage the product from the computer

---

 **NOTE:** You must perform a complete software installation to use Macintosh Configure Device.

---

- Check the product status and print information pages.
- Check and change product system settings.
- Check default print settings.
- Check and change fax settings, including fax send, fax receive, fax phone book and speed-dial settings, and fax reports.
- Check and change network settings, including IP configuration, Advanced, mDNS, SNMP, network configuration, and password.

You can view Macintosh Configure Device when the product is directly connected to your computer or when it is connected to the network.

---

 **NOTE:** You do not have to have Internet access to open and use Macintosh Configure Device.

---

### To view Macintosh Configure Device when the product is directly connected to the computer

1. Open HP Director by clicking the **HP Director** icon in the dock.
2. In HP Director, click **Settings**.
3. Select **Configure device** to open the Macintosh Configure Device home page in a browser.

### To view Macintosh Configure Device when the product is connected to a network

1. Open one of the following supported Web browsers:
  - Safari 1.2 or later
  - Microsoft Internet Explorer 5.0 or later

- Netscape Navigator 4.75 or later
  - Opera 6.05 or later
2. Type the IP address of the product into the Web browser to open the Macintosh Configure Device home page.

---

# 4 Theory of operation

- [Basic operation](#)
- [Scanner and ADF functions and operation](#)
- [Internal components \(base unit\)](#)
- [Engine control system](#)
- [Laser/scanner system](#)
- [Pickup/feed/delivery system](#)
- [Image-formation system](#)
- [Fax functions and operation](#)

## Basic operation

This chapter presents an overview of the relationships between major components in the product, and includes a detailed discussion of the image-formation system. The following systems are discussed:

- Engine control system
- Laser/scanner system
- Pickup/feed/delivery system
- Image-formation system

**Figure 4-1** HP LaserJet M2727 MFP system block diagram

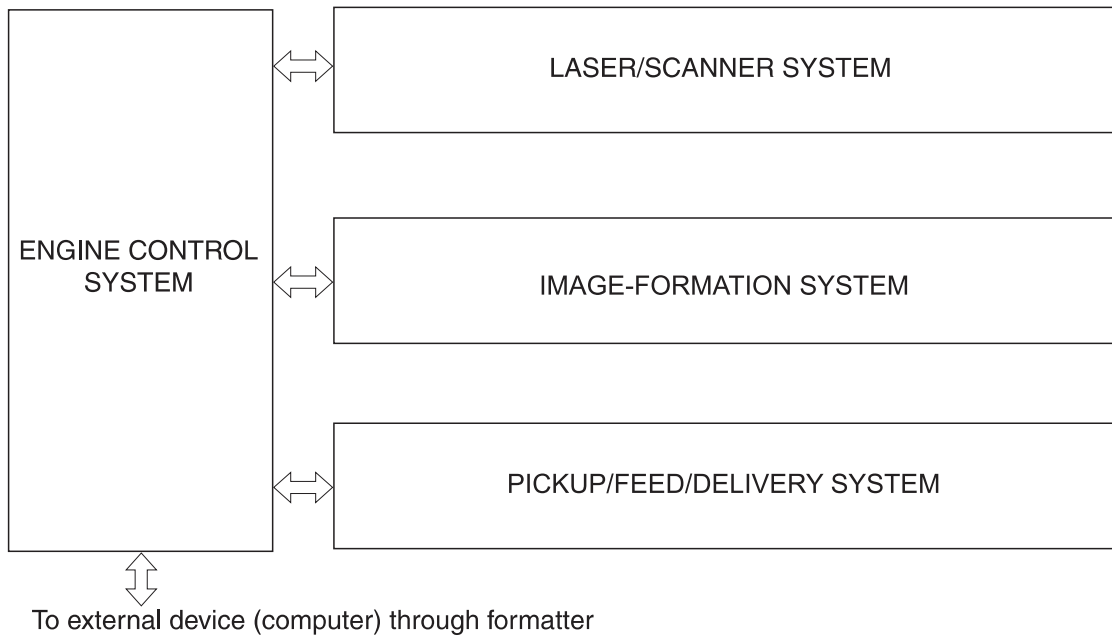

## Sequence of operation for the base unit

Operational sequences are controlled by the microprocessor and the DC controller.

**Table 4-1** Sequence of operation

| Name                    | Timing   | Purpose  |
|-------------------------|--|--|
| WAIT                    | From power-on until the end of the main-motor initial drive  | Detects the presence of a print cartridge; clears potential from the drum surface and cleans the transfer roller<br><br>See <a href="#">Table 4-2 Power-on sequence on page 71</a> for a complete description of the WAIT (power-on) period. |
| STBY (standby)          | From the end of the WAIT or LSTR period until either a print command is sent from the formatter or the power is turned off | Prepares the product to receive print commands   |
| INTR (initial rotation) | From the time of the print command until the pickup solenoid is turned on  | Prepares the photosensitive drum for printing  |

**Table 4-1 Sequence of operation (continued)**

| Name                 | Timing   | Purpose  |
|----------------------|--|--|
| PRINT                | From the end of the INTR period until the primary high-voltage is turned off                           | Forms the image on the photosensitive drum and transfers the toner image to the media  |
| LSTR (last rotation) | From the end of the PRINT period (when high-voltage is turned off) until the main motor stops rotating | Delivers the last page of a print job<br><br>After LSTR, the product either returns to STBY or, if another print command was sent from the formatter, enters INTR. |

**Table 4-2 Power-on sequence**

| Step | Action  |
|------|---|
| 1    | Power-on  |
| 2    | CPU initialization  |
| 3    | Start video interface communication   |
| 4    | Check sensors for residual media  |
| 5    | Main motor initial drive  |
| 6    | Fuser heater initial drive. The fuser heater reaches a surface temperature of 100° C.   |
| 7    | Laser/scanner motor initial drive   |
| 8    | High-voltage control<br><br>Detect presence of a print cartridge<br><br>Clean the transfer roller after the primary charging AC bias is turned on |
| 9    | Failure/abnormality check: detect laser/scanner failure, fuser failure, and open covers   |
| 10   | Communication with the memory tag   |

## Scanner and ADF functions and operation

The following sections describe how the document scanner and the automatic document feeder (ADF) function.

### Scanner functions

The scanner uses a light source, a color-separation method, and a charge-coupled device array (CCD) to collect optical information about the document and transform that into an image file. The scanner consists of these elements:

- A lamp (LED)
- Five mirrors and a lens
- A CCD

**Figure 4-2** Optical system

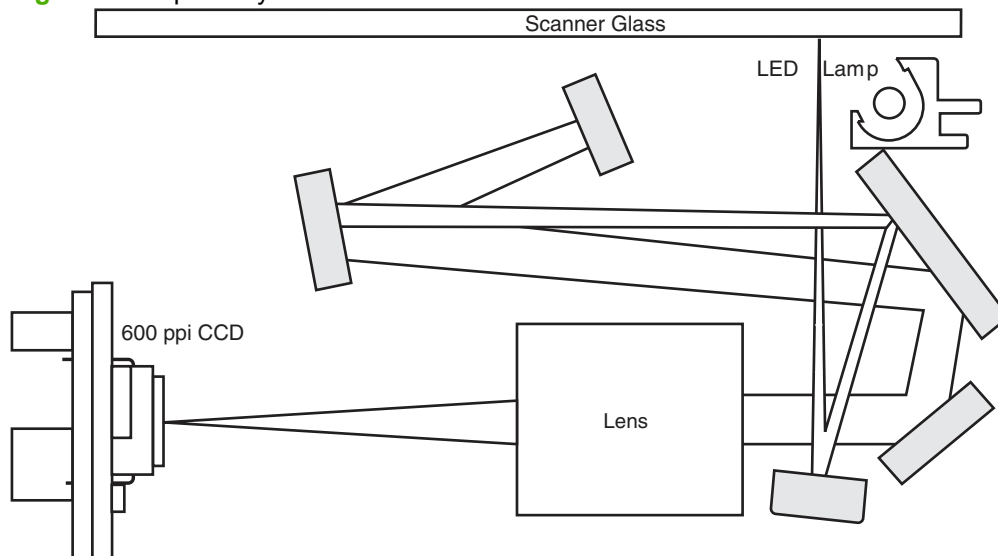

The scanner lamp illuminates a small strip of the document (called the *raster line*). The mirrors direct the light through the lens to the CCD. The CCD senses and records the light, creating an analog representation of the raster line. If the ADF is being used, the document then advances in the ADF to the next raster line. If the flatbed is being used, the scanner module advances to the next raster line. This advancing and collection process continues to the end of the sheet.

The image data is collected in the motor controller board, where it is processed and sent to the formatter. The formatter then handles the image data, outputting it as a copy, sending it through the Fax Card as a fax, or directing it to the computer as scanner output.

The image data collected is 600 pixels per inch (ppi). Each pixel has 8 bits for each of the three colors (256 gray scale levels for each color), or a total of 24 bits per pixel (24-bit color).

## Scanner operation

At power-on and periodically at other times, the scanner assembly moves systematically to locate its home position. It then calibrates to a white strip located under the glass at the right end of the scan tub.

If the product detects a document in the ADF when a copy or scan is initiated (from the software or the control panel), the scan module moves to the left side of the scan tub and stops. The image is acquired as the paper is fed through the ADF past the scanner module.

If no document is detected in the ADF, the scan module acquires the image from the flatbed glass while slowly moving within the scan tub.

## ADF operation

**Standby (paper-loading) mode:** In standby mode, the pickup roller is up and the stack-stop is down, preventing the user from inserting the original document too far. When a document is inserted correctly, the paper-present sensor detects its presence.

The standard operation of the ADF consists of the pick, feed, and lift steps.

**Pick:** When it receives a copy or scan command, the ADF motor engages the gear train to lower the pickup-roller assembly and raise the stack-stop. The first roller, called the pre-pick roller, moves the top few sheets forward into the ADF. The next roller is the pickup roller. This roller contacts the ADF separation pad, which separates multiple pages into single sheets.

**Feed:** The single sheet continues through the path. Along the way, the form sensor, which is a set distance from the ADF glass, detects the sheet. This alerts the scanner to start when the page reaches the glass. The scanner acquires the image, one raster line at a time, until it detects the end of the page. The page is then ejected. The pick and feed steps are repeated as long as paper is detected in the ADF input tray.

**Lift:** When no more paper is detected in the ADF input tray and the form sensor detects the trailing edge of the last page, the last sheet is ejected and the motor turns in a sequence that lifts the pick-roller assembly to standby (paper-loading) mode again.

The ADF will not function when the ADF cover is open. The paper path is incomplete if the ADF cover is lifted from the glass.

## ADF paper path and ADF sensors

The following diagram shows the ADF paper path.

**Figure 4-3** ADF paper path

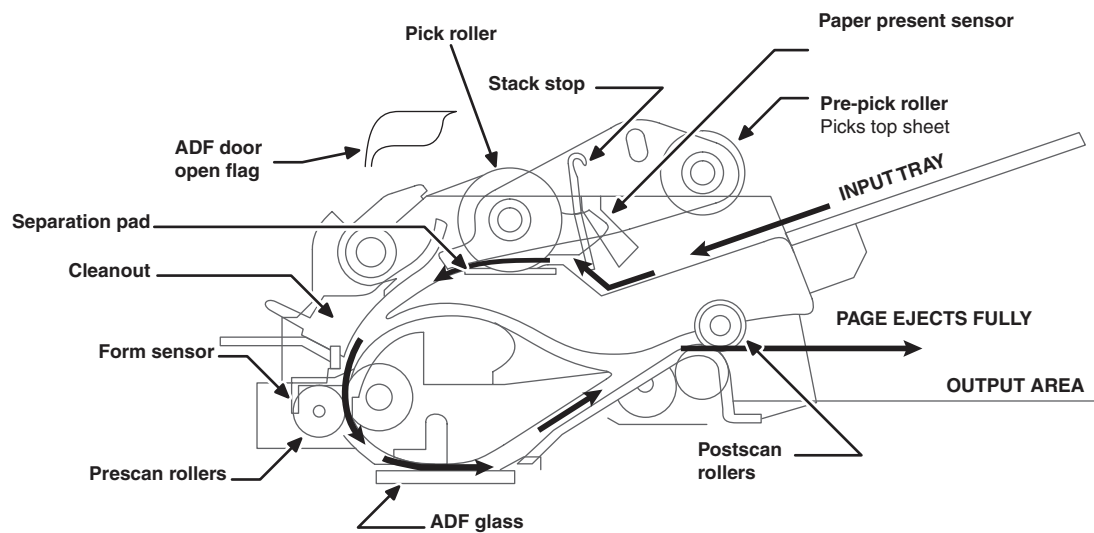

The paper-present sensor determines if paper is in the ADF. The form sensor detects the top and bottom edges of the document. One other sensor detects an open ADF door.



## ADF jam detection

The ADF has two sensors that detect paper. The paper-present sensor detects the presence of media in the ADF input tray. The form sensor detects media moving through the ADF. If a jam is detected, the ADF immediately stops the paper feeding and a jam message appears on the control-panel display.

A jam can be detected under any of the following conditions:

- **Document-feeder jam.** When documents are detected in the ADF input tray, and a command to copy, scan or fax is received, the scan module travels to the left side of the scan assembly and stops beneath the ADF scanner glass. The ADF then attempts three times, or for about ten seconds, to advance the paper to the form sensor. If the paper does not advance, the scan module travels back to the home position on the right side of the scanner assembly. The message **Document feeder mispick. Reload.** appears on the control-panel display.
- **Long-document jam.** If the paper has advanced to trigger the form sensor, but the trailing edge is not detected within the time allowed for a 381-mm (15-inch) document (the maximum allowable page length for the ADF), the scanner returns to the home position on the right side of the scanner assembly. The message **Doc feeder jam. Clear, Reload.** appears on the control-panel display.
- **Stall jam.** When a page that is less than 381 mm (15 inches) long has advanced to the form sensor but has not left it within the expected time, the paper has probably stalled or jammed. The scanner returns to the home position on the right side of the scanner assembly. The message **Doc feeder jam. Clear, Reload.** appears on the control-panel display.
- **Other.** If the paper stops in the ADF and the scan module remains under the ADF scanner glass, an internal firmware error has probably occurred. This is usually remedied by cycling the power.

# Internal components (base unit)

Figure 4-4 Cross-section of printer on page 76 highlights the major internal components.

Figure 4-4 Cross-section of printer

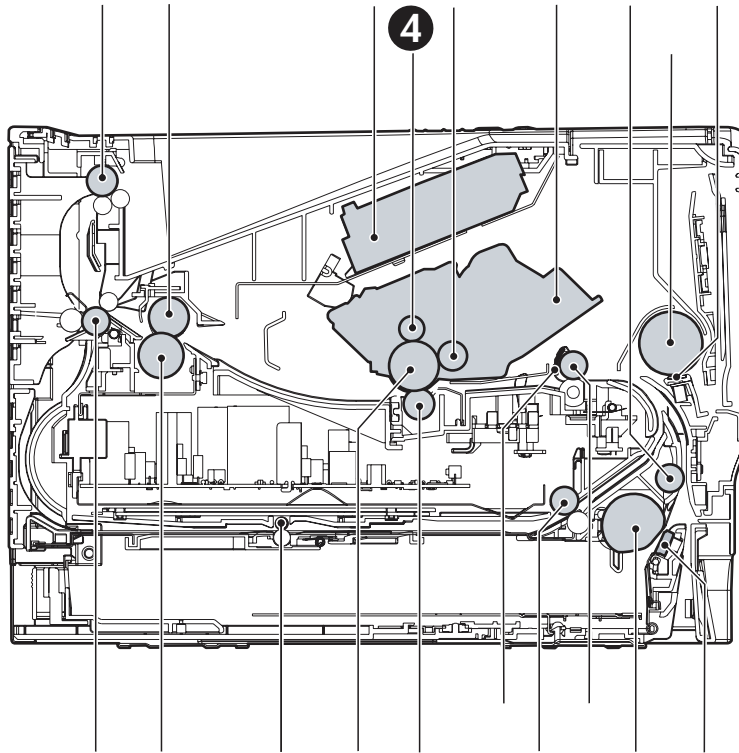

|    |                                |
|----|--------------------------------|
| 1  | Top output bin delivery roller |
| 2  | Fuser film                     |
| 3  | Laser/scanner                  |
| 4  | Primary charging roller        |
| 5  | Developer roller               |
| 6  | Print cartridge                |
| 7  | Feed roller                    |
| 8  | Multipurpose pickup roller     |
| 9  | Multipurpose separation pad    |
| 10 | Separation pad                 |
| 11 | Pickup roller                  |
| 12 | Registration roller            |
| 13 | Duplexer pickup roller         |
| 14 | Registration shutter           |

|    |                                 |
|----|---------------------------------|
| 15 | Transfer roller                 |
| 16 | Photosensitive drum             |
| 17 | Duplexer feed roller            |
| 18 | Pressure roller                 |
| 19 | Rear output bin delivery roller |

# Engine control system

The engine control system coordinates all of the product functions, according to commands sent from the formatter. It drives the laser/scanner system, the image-formation system, and the pickup/feed/delivery system.

The engine control system contains the following components:

- Formatter
- High-voltage PCA

**Figure 4-5** Engine control system

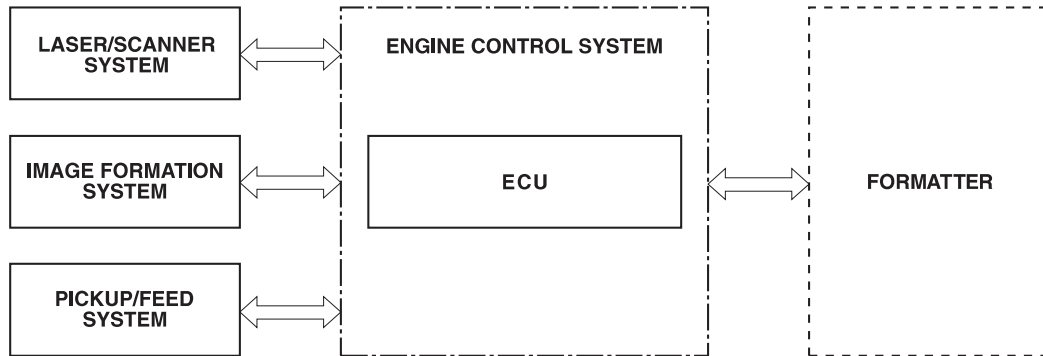

**Figure 4-6** Engine-control-system circuit diagram

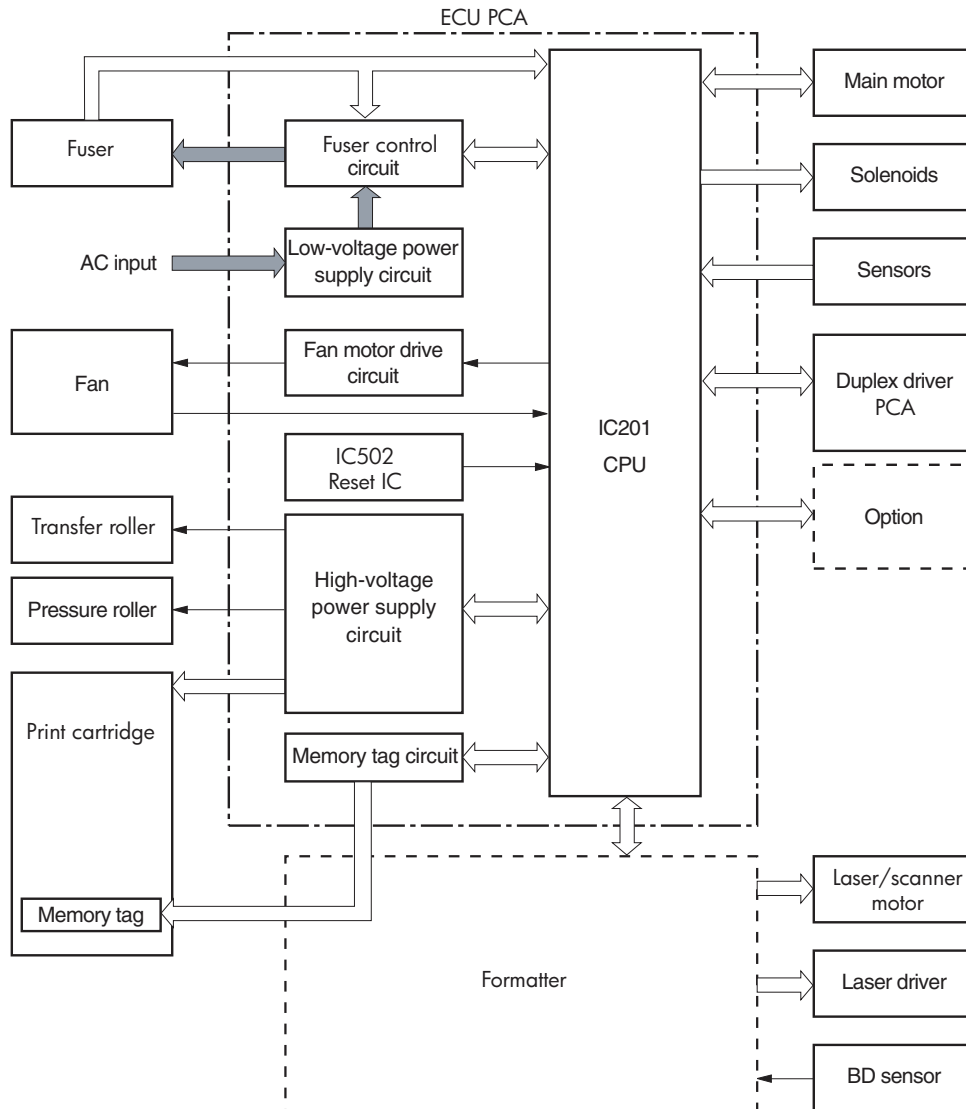

# Laser/scanner system

The laser/scanner system receives video signals from the DC controller and the formatter, and converts the signals into latent images on the photosensitive drum.

Figure 4-7 Laser/scanner system

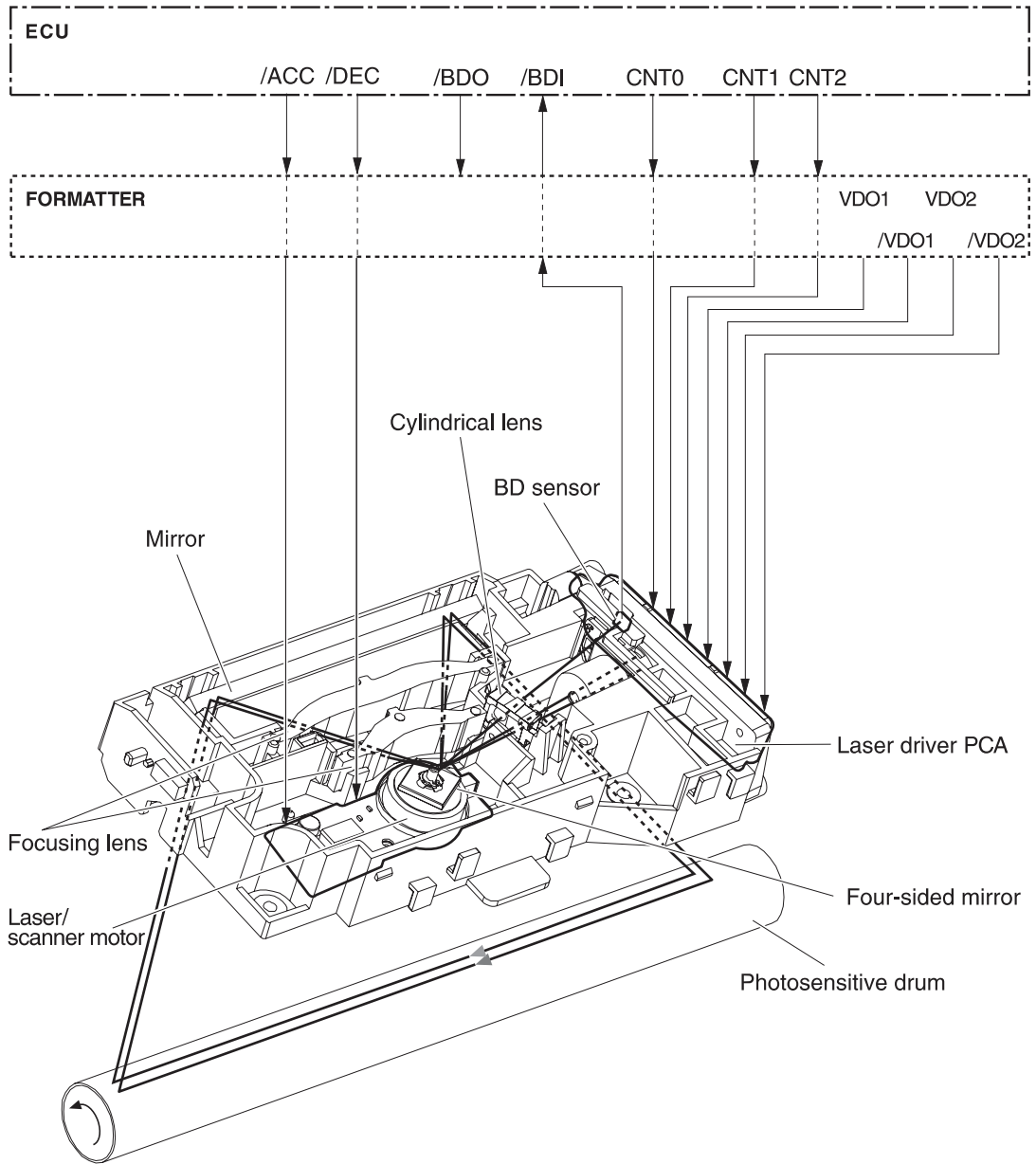

## Pickup/feed/delivery system

The pickup/feed/delivery system consists of several types of feed rollers and sensors. The DC controller uses two motors and two solenoids to drive the rollers. Three media-detection sensors detect media as it passes through the printer. If media does not reach or pass each sensor within a specified time period, the DC controller determines that a jam has occurred and alerts the formatter.

The following components are identified in [Figure 4-8 Pickup/feed/delivery system on page 82](#):

- M1, main motor
- SL1, tray 2 pickup solenoid
- SL2, tray 1 pickup solenoid
- SL3, duplex solenoid
- PS911, width-detection sensor
- PS912, top-of-page sensor
- PS913, width-detection sensor
- PS914, tray 2 media sensor
- PS915, fuser-delivery sensor and duplex sensor

 **NOTE:** This sensor has two sensor flags; one flag detects the media when it is delivered from the fuser, and the other flag detects the media when it is reversed for duplexing.

**Figure 4-8** Pickup/feed/delivery system

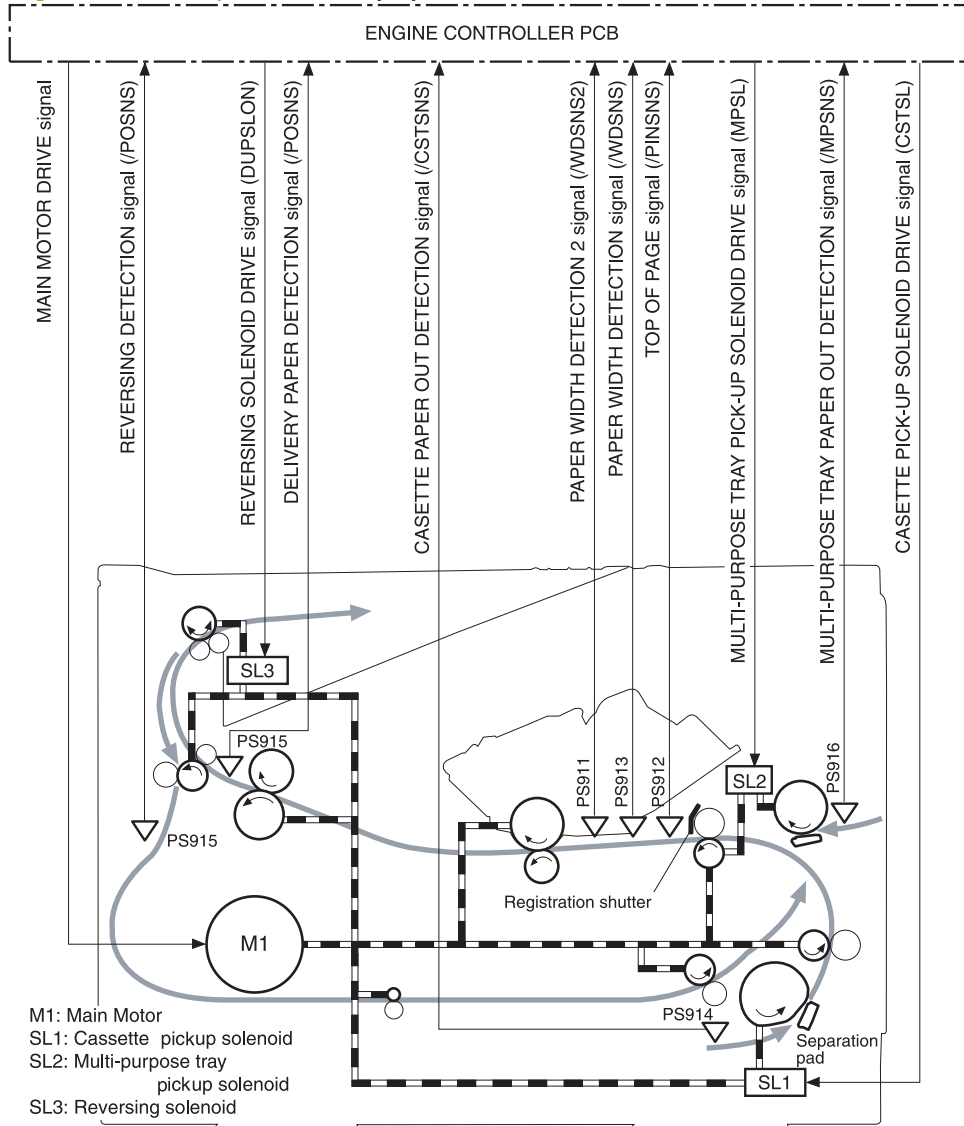



# Image-formation system

Laser printing requires the interaction of several technologies, including electronics, optics, and electrophotographics, to produce a printed page. Each process functions independently and must be coordinated with the other product processes. Image formation consists of the following five processes:

- Electrostatic latent-image formation
- Developing
- Transfer
- Fusing
- Drum cleaning

These five processes contain seven steps, which are shown in [Figure 4-9 Image-formation system on page 83](#) and described in the following sections.

**Figure 4-9** Image-formation system

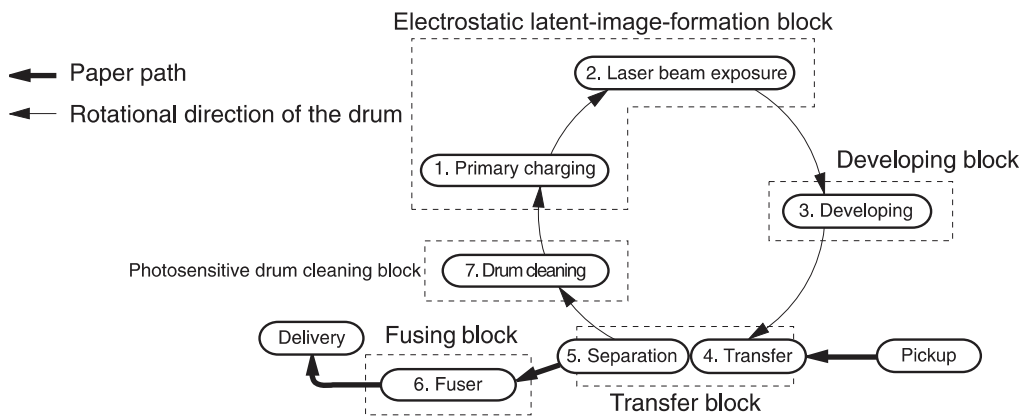

## Step 1: Primary charging

DC and AC biases are applied to the primary charging roller, which transfers a uniform negative potential to the photosensitive drum.

**Figure 4-10** Primary charging

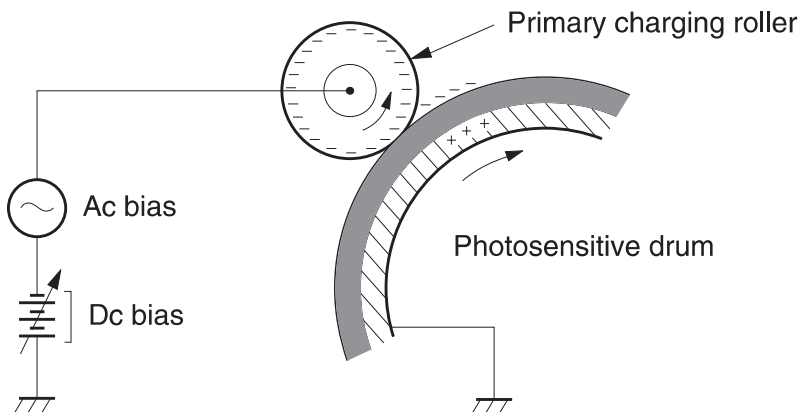

### Step 2: Laser beam exposure

The laser beam scans the photosensitive drum to neutralize negative charges on parts of the drum. An electrostatic latent image is formed on the drum where negative charges were neutralized.

### Step 3: Developing

The developing cylinder comes in contact with the photosensitive drum to deposit toner onto the electrostatic latent image.

**NOTE:** The charges on the exposed area of the drum are shown as positive in [Figure 4-11 Developing on page 84](#). The charges are actually negative, but they are more positive than the charges on the developing cylinder.

**Figure 4-11** Developing

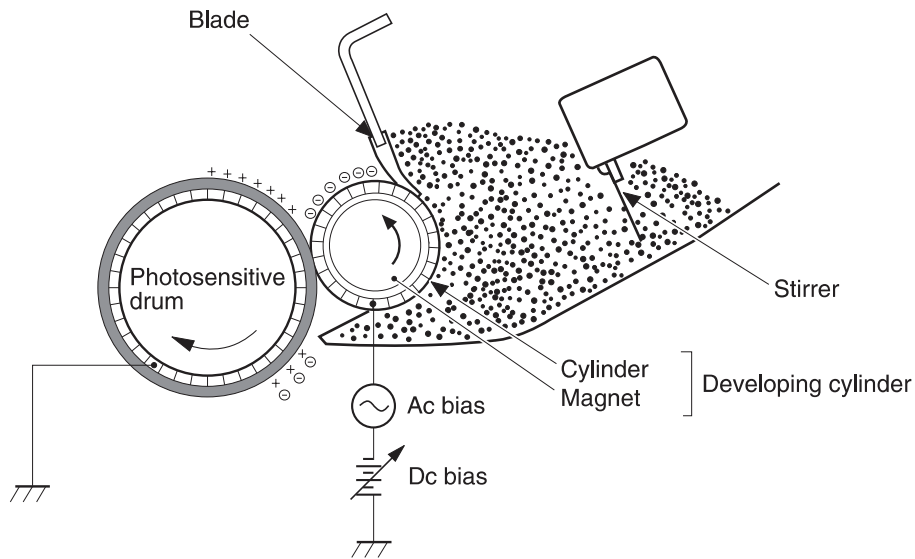

Toner acquires a negative charge through friction from the developing cylinder and the blade. When the negatively charged toner comes in contact with the drum, the toner adheres to the electrostatic latent image. The image on the drum becomes visible because of the toner.

### Step 4: Transfer

The transfer charging roller, to which a DC positive bias is applied, imparts a positive charge on the print media. When the print media comes in contact with the photosensitive drum, the toner is transferred to the print media.

**Figure 4-12** Transfer

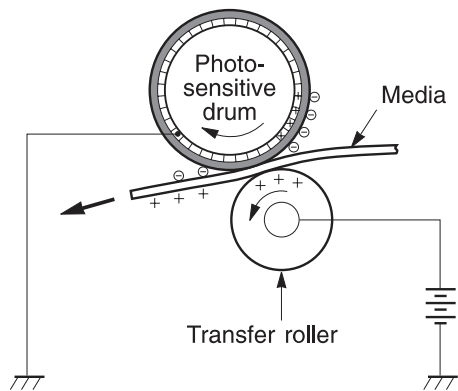

**Step 5: Separation**

The elasticity of the print media causes its separation from the photosensitive drum. A static-charge eliminator aids separation by weakening any electrostatic adhesion.

**Figure 4-13** Separation

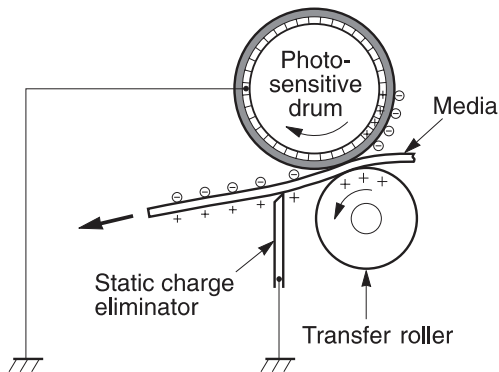

**Step 6: Fusing**

The DC negative bias applied to the fusing film strengthens the holding force of the toner on the print media and prevents the toner from scattering.

**Figure 4-14** Fusing

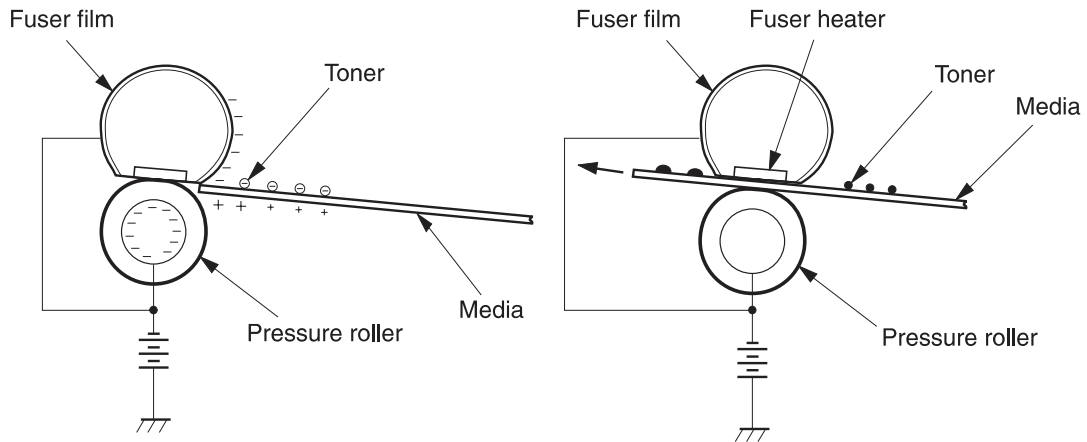

**Step 7: Drum cleaning**

The cleaning blade scrapes the residual toner off of the photosensitive drum and deposits it into the waste-toner case.

**Figure 4-15** Drum cleaning

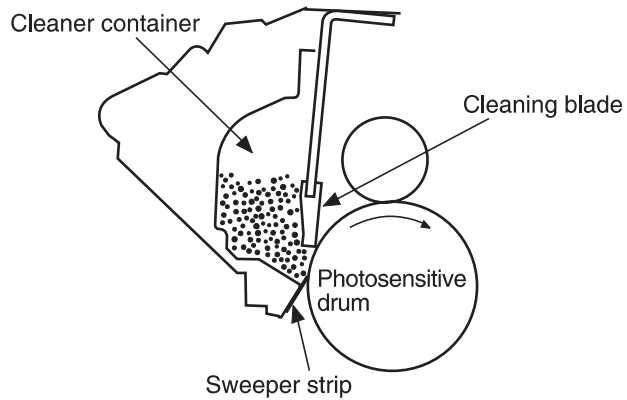

# Fax functions and operation

The following sections describe the product fax capabilities.

## Computer and network security features

The product can send and receive fax data over telephone lines that conform to public switch telephone network (PSTN) standards. The secure fax protocols make it impossible for computer viruses to be transferred from the telephone line to a computer or network.

The following product features prevent virus transmission:

- No direct connection exists between the fax line and any devices that are connected to the USB or Ethernet ports.
- The internal firmware cannot be modified through the fax connection.
- All fax communications go through the fax subsystem, which does not use Internet data-exchange protocols.

## PSTN operation

The PSTN operates through a central office (CO) that generates a constant voltage on the TIP and RING wires (48 V, usually). A device goes on-hook by connecting impedance (such as 600 ohms for the U.S.) across the TIP and RING so that a line current can flow. The CO can detect this current and can send impulses like dial tones. The product generates more signaling tones, such as dialing digits, to tell the CO how to connect the call. The product can also detect tones, such as a busy tone from the CO, that tell it how to behave.

When the call is finally connected, the CO behaves like a piece of wire connecting the sender and receiver. This is the period during which all of the fax signaling and data transfer occurs. When a call is completed, the circuit opens again and the line-current flow ceases, removing the CO connection from both the sender and the receiver.

On most phone systems, the TIP and RING wires appear on pins 3 and 4 of the RJ-11 modular jack (the one on the fax card). These two wires do not have to be polarized because all the equipment works with either TIP or RING on pin 3 and the other wire on pin 4. This means that cables of either polarity can interconnect and will still work.

These basic functions of PSTN operation are assumed in the design of the fax subsystem. The product generates and detects the signaling tones, currents, and data signals that are required to transmit and receive faxes on the PSTN.

## Receive faxes when you hear fax tones

In general, incoming faxes to the product are automatically received. However, if other devices are connected to the same phone line, the product might not be set to answer automatically.

If the product is connected to a phone line that receives both fax and phone calls, and you hear fax tones when you answer the extension phone, receive the fax in one of two ways:

- If you are near the product, press **Start Fax** on the control panel.
- Press 1-2-3 in sequence on the extension phone keypad, listen for fax transmission sounds, and then hang up.

---

 **NOTE:** In order for the 1-2-3 sequence to work, the extension phone setting must be set to **On** in the **Fax setup** menu.

---

## Distinctive ring function

Distinctive ring is a service that a telephone company provides. The distinctive ring service allows three phone numbers to be assigned to one phone line. Each phone number has a distinctive ring. The first phone number has a single ring, the second phone number has a double ring, and the third phone number has a triple ring.

---

 **NOTE:** The product has not been tested with all of the distinctive-ring services that telephone companies provide in all countries/regions. HP does not guarantee that the distinctive-ring function will operate correctly in all countries/regions. Contact the local phone service provider for assistance.

---

### Set up the distinctive ring function

1. Press **Setup**. Use the arrow buttons to select **Fax setup** and then press **OK**.
2. Use the arrow buttons to select **Fax recv. setup** and then press **OK**.
3. Use the arrow buttons to select **Answer ring type** and then press **OK**.
4. Use the arrow buttons to select one of the following options:

---

 **NOTE:** The control-panel display might show some of these options as abbreviations.

---

- **All rings** (default setting)
- **Single**
- **Double**
- **Triple**
- **DoubleTriple**

Press **OK** to save the setting.

## Fax by using Voice over IP services

Voice over IP (VoIP) services provide normal telephone service, including long distance service through a broadband Internet connection. These services use packets to break up the voice signal on a telephone line and transmit it digitally to the receiver, where the packets are reassembled. The VoIP services are often not compatible with fax machines. The VoIP provider must state the service supports fax over IP services.

Because the installation process varies, the VoIP service provider will have to assist in installing the product fax component.

Although a fax might work on a VoIP network, it can fail when the following events occur:

- Internet traffic becomes heavy and packets are lost.
- Latency (the time it takes for a packet to travel from its point of origin to its point of destination) becomes excessive.

If you experience problems using the fax feature on a VoIP network, ensure that all of the product cables and settings are correct. Configuring the **Fax Speed** setting to **Medium(V.17)** or **Slow(V.29)** can also improve your ability to send a fax over a VoIP network. See [Table 6-8 Fax setup menu on page 194](#).

If you continue to have problems faxing, contact your VoIP provider.

## The fax subsystem

The formatter, fax card, firmware, and software all contribute to the fax functionality. The designs of the formatter and fax card, along with parameters in the firmware, determine the majority of the regulatory requirements for telephony on the product.

The fax subsystem is designed to support V.34 fax transmission, lower speeds (such as V.17 fax), and older fax machines.

## Fax card in the fax subsystem

Two versions of the fax card are used in the HP LaserJet M2727 MFP. One is used in the North American, South American, and Asian countries/regions. The other is used primarily in European countries/regions.

The fax card contains the modem chipset (DSP and CODEC) that controls the basic fax functions of tone generation and detection, along with channel control for fax transmissions. The CODEC and its associated circuitry act as the third-generation silicon DAA to achieve compliance world-wide regulatory requirements.

The only difference between the two versions is that each version is compliant with the 2/4-wire phone jack system from the respective country/region.

## Safety isolation

The most important function of the fax card is the safety isolation between the high-voltage, transient-prone environment of the telephone network (TNV [telephone network voltage]) and the low-voltage analog and digital circuitry of the formatter (SELV [secondary extra-low voltage]). This safety isolation provides both customer safety and product reliability in the telecom environment.

Any signals that cross the isolation barrier do so magnetically. The breakdown voltage rating of barrier-critical components is greater than 5 kV.

## Safety-protection circuitry

In addition to the safety barrier, the fax card protects against over-voltage and over-current events.

Telephone over-voltage events can be either differential mode or common mode. The event can be transient in nature (a lightning-induced surge or ESD) or continuous (a power line crossed with a phone line). The fax card protection circuitry provides margin against combinations of over-voltage and over-current events.

Common mode protection is provided by the selection of high-voltage-barrier critical components (transformer and relay). The safety barrier of the fax card PCB traces and the clearance between the fax card and surrounding components also contribute to common mode protection.

A voltage suppressor (a crowbar-type SIDACTOR) provides differential protection. This device becomes low impedance at approximately 300 V differential, and crowbars to a low voltage. A series thermal switch works in conjunction with the crowbar for continuous telephone line events, such as crossed power lines.

All communications cross the isolation barrier magnetically. The breakdown voltage rating of barrier-critical components is greater than 5 kV.

## Data path

TIP and RING are the two-wire paths for all signals from the telephone network. All signaling and data information comes across them, including fax tones and fax data.

The telephone network uses DC current to determine the hook state of the telephone, so line current must be present during a call. The silicon DAA provides a DC holding circuit to keep the line current constant during a fax call.

The silicon DAA converts the analog signal to a digital signal for DSP processing, and also converts the digital signal to an analog signal for transmitting data through a telephone line.

The magnetically coupled signals that cross the isolation barrier go either through a transformer or a relay.

The DSP in the fax card communicates with the ASIC in the formatter using the high-speed serial interface.

## Hook state

Another magnetically coupled signal is the control signal that disconnects the downstream telephone devices (such as a phone or answering machine). A control signal originating on the DSP can change the relay state, causing the auxiliary jack (downstream jack) to be disconnected from the telephone circuit.

The product takes control of calls that it recognizes as fax calls. If the product does not directly pick up the call, it monitors incoming calls for the fax tone or for the user to direct it to receive a fax. This idle mode is also called eavesdropping. This mode is active when the product is on-hook but current exists in the downstream phone line because another device is off-hook. During eavesdropping, the receive circuit is enabled but has a different gain from the current that is generated during normal fax transmissions.

The product does not take control of the line unless it detects a fax tone or the user causes it to connect manually. This feature allows the user to make voice calls from a phone that is connected to the product without being cut off if a fax is not being received.

## Downstream device detection

The line voltage monitoring module of the silicon DAA can detect the line state as well as the downstream device. It tells DSP via DIB that an active device (telephone, modem, or answering machine) is connected to the auxiliary port on the product (the right side of the RJ-11 jack). The DSP uses the signal to ensure that the product does not go off-hook (and disconnect a downstream call) until it has been authorized to do so (by a manual fax start or the detection of the appropriate tones).

## Hook switch control

In the silicon DAA the CODEC controls the hook switch directly. The CODEC is activated when it receives commands from the DSP. When the circuit is drawing DC current from the central office it is considered off-hook. When no DC current flows the state is considered on-hook.



## Ring detect

Ring detect is performed by the line voltage monitoring module of the silicon DAA, and is a combination of voltage levels and cadence (time on and time off). Both must be present to detect a valid ring. The CODEC works with DSP as well as the firmware to determine if an incoming signal is an answerable ring.

## Line current control

The DC current from the CO needs to have a path to flow from TIP to RING. The DC impedance emulation line modulator and DC terminations modules in the silicon DAA act as a DC holding circuit, and works with the firmware to achieve the voltage-current characteristic between TIP and RING. The impedance (the current-voltage characteristic) changes corresponding to certain special events, such as pulse dialing or when the product goes on-hook.

## Billing- (metering-) tone filters

Switzerland and Germany provide high-frequency AC signals on the phone line in order to bill customers.

A filter in a special fax cable (for certain countries/regions), can filter these signals. Because these billings signals are not used in the U.S., these filters are not present in the U.S. fax cable.

To obtain a special fax cable, contact your local telephone service provider.

## Fax page storage in flash memory

Fax pages are the electronic images of the document page. They can be created in any of three ways: scanned to be sent to another fax machine, generated to be sent by the computer, or received from a fax machine to be printed.

The product stores all fax pages in flash memory automatically. After these pages are written into flash memory, they are stored until the pages are sent to another fax machine, printed on the product, transmitted to the computer, or erased by the user.

These pages are stored in flash memory, which is the nonvolatile memory that can be repeatedly read from, written to, and erased. The product has 8 MB of flash memory, of which 7.5 MB is available for fax storage. The remaining 0.5 MB is used for the file system and reclamation. Adding RAM does not affect the fax page storage because the product does not use RAM for storing fax pages.

## Stored fax pages

The user can reprint stored fax receive pages in case of errors. For a fax send, the product will re-send the fax in case of errors. The product will re-send stored fax pages after a busy signal, comm error, no answer, or power failure. Other fax devices store fax pages in either normal RAM or short-term RAM. Normal RAM immediately loses its data when power is lost, while short-term RAM loses its data about 60 minutes after power failure. Flash memory maintains its data for years without any applied power.

## Advantages of flash memory storage

Fax pages that are stored in flash memory are persistent. They are not lost as a result of a power failure, no matter how long the power is off. Users can reprint faxes in case the print cartridge runs out of toner or the product experiences other errors while printing faxes.

The product also has scan-ahead functionality that makes use of flash memory. Scan-ahead automatically scans pages into flash memory before a fax job is sent. This allows the sender to pick up

the original document immediately after it is scanned, eliminating the need to wait until the fax is transmission is complete.

Because fax pages are stored in flash memory rather than RAM, more RAM is available to handle larger and more complicated copy and print jobs.

---

# 5 Removal and replacement

- [Introduction](#)
- [External panels, covers, and doors](#)
- [Replace the ADF pickup-roller assembly](#)
- [ADF scanner glass](#)
- [ADF assembly](#)
- [Scanner/ADF assembly](#)
- [Bezel and control panel](#)
- [Internal assemblies](#)

## Introduction

This chapter documents the removal and replacement of field replaceable units (FRUs) only.

Replacing FRUs is generally the reverse of removal. Occasionally, notes and tips are included to provide directions for difficult or critical replacement procedures.

HP does *not* support repairing individual subassemblies or problem-solving at the component level.

Note the length, diameter, color, type, and location of each screw. Be sure to return each screw to its original location during reassembly.

Incorrectly routed or loose wire harnesses can interfere with other internal components and can become damaged or broken. Frayed or pinched harness wires can be difficult to locate. When replacing wire harnesses, always use the provided wire loops, lance points, or wire-harness guides.

## Removal and replacement strategy

- ! **WARNING!** Turn the product off, wait 5 seconds, and then remove the power cord before attempting to service the product. If this warning is not followed, severe injury can result, as well as damage to the product. The power must be on for certain functional checks during problem solving. However, the power supply should be disconnected during parts removal.

Never operate or service the product with the protective cover removed from the laser/scanner assembly. The reflected beam, although invisible, can damage your eyes.

The sheet-metal parts can have sharp edges. Be careful when handling sheet-metal parts.

**CAUTION:** Do not bend or fold the flat flexible cables (FFCs) during removal or installation. Also, do not straighten pre-folds in the FFCs. You *must* make sure that all FFCs are fully seated in their connectors. Failure to fully seat an FFC into a connector can cause a short circuit in a PCA.

- 📄 **NOTE:** To install a self-tapping screw, first turn it counterclockwise to align it with the existing thread pattern, and then carefully turn it clockwise to tighten. Do not overtighten. If a self-tapping screw hole becomes stripped, repair the screw hole or replace the affected assembly.

## Electrostatic discharge



**CAUTION:** Some parts are sensitive to electrostatic discharge (ESD). Look for the ESD reminder when removing product parts. Always perform service work at an ESD-protected workstation or mat. If an ESD workstation or mat is not available, ground yourself by touching the sheet-metal chassis *before* touching an ESD-sensitive part.

Protect the ESD-sensitive parts by placing them in ESD pouches when they are out of the product.

## User-replaceable parts

To remove and replace the tray 2 pickup roller or the tray 2 or tray 3 separation pad, see [Replace the tray 2 pickup roller on page 40](#) or [Replace the tray 2 and optional tray 3 separation pad on page 45](#).

## Required tools

- #2 Phillips screwdriver with a magnetic tip and a 152-mm (6-inch) shaft length
- Small flatblade screwdriver
- #8 torx driver
- #10 torx driver
- Needle-nose pliers
- ESD mat (if one is available)
- Penlight (optional)

---

**CAUTION:** Always use a Phillips screwdriver (callout 1). Do not use a pozidrive screwdriver (callout 2) or any motorized screwdriver. These can damage screws or screw threads.

**CAUTION:** Do *not* pull directly on the wires to disconnect them. *Always* pull on the plastic body of a connector to avoid damaging the connector wires.

---

**Figure 5-1** Phillips and pozidrive screwdriver comparison

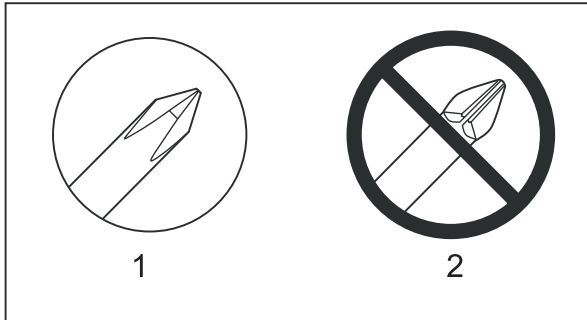

## Before performing service

- Remove all media from the product.
- Turn off the power using the power switch.
- Unplug the power cable and interface cable(s).
- Place the product on an ESD mat (if one is available). If an ESD workstation or mat is not available, ground yourself by touching the sheet-metal chassis *before* touching an ESD-sensitive part.
- Remove the print cartridge. See [Remove the print cartridge on page 99](#).
- Remove the tray 2 cassette.
- Lift the product off of the optional tray 3 (if it is installed).

## After performing service

- Return all media to the trays.
- Plug in the power cable.
- Reinstall the print cartridge.
- Reinstall the tray 2 cassette.
- Replace the product on the optional tray 3 (if present).

## Post-service tests

After service has been completed, the following tests can be used to verify that the repair or replacement was successful.

### Test 1 (print-quality test)

1. Verify that you have completed the necessary reassembly steps.
2. Ensure that the input tray contains clean, unmarked paper.
3. Attach the power cord and interface cable, and then turn on the product.
4. Verify that the expected start-up sounds occur.
5. Perform a control-panel test from the secondary service menu. Verify that the control-panel buttons beep when they are pressed.

---

 **NOTE:** If the control-panel buttons do not beep, verify that the user did not disable this function.

6. Print a configuration page, and then verify that the expected printing sounds occur. See [Product information pages and reports on page 237](#).
7. Print a demo page, and then verify that the print quality is as expected. See [Product information pages and reports on page 237](#).
8. Send a print job from the host computer, and then verify that the output meets expectations.
9. If necessary, restore any customer-specified settings.
10. Clean the outside of the product with a damp cloth.

### Test 2 (copy-quality test)

1. Verify that you have completed the necessary reassembly steps.
2. Ensure that the input tray contains clean, unmarked paper.
3. Attach the power cord and interface cable, and then turn on the product.
4. Verify that the expected start-up sounds occur.
5. Print a configuration page, and then verify that the expected printing sounds occur. See [Product information pages and reports on page 237](#).
6. Place the configuration page in the ADF.

7. Print a copy job, and then verify the results.
8. Place the configuration page on the scanner glass.
9. Print a copy job, and then verify the results.
10. Clean the outside of the product with a damp cloth.

### **Test 3 (fax-quality test)**

1. Place the configuration page in the ADF.
2. Type a valid fax number and send the fax job.
3. Verify that the send quality and receive quality meet expectations.

## Parts removal order

Use the following diagram to determine which parts must be removed before removing other parts.

**Figure 5-2** Parts-removal tree

ADF

Bezel and control panel

Convenience stapler cartridge

Print cartridge

Transfer roller

Right cover

Left cover

Convenience stapler assembly

Convenience stapler inlet cable

Power switch PCA

Convenience stapler bracket and strap

Print-cartridge door

Top cover (Note: scanner assembly removed)

Rear cover

Registration assembly

Convenience stapler power supply

Note: Convenience stapler components are only for the HP LaserJet M2727nfs.

Scanner assembly

Speaker

Formatter

Note: some formatters will include an Asian character control panel display PCA.

Duplex assembly

Laser/scanner assembly

Memory-tag reader assembly

Fan

Interlock assembly

Duplex-drive gears (Note: formatter removed)

Fuser

Main drive gears

Tray 2 pickup assembly

ECU (Note: interlock assembly removed)

Main motor



## Remove the print cartridge

**CAUTION:** If toner gets on your clothing, wipe it off with a dry cloth and wash the clothing in cold water. *Hot water sets toner into the fabric.*

1. Open the print-cartridge door.

**Figure 5-3** Remove the print cartridge (1 of 2)



2. Grasp the handle on the print cartridge and then pull the cartridge straight out to remove it.

**Figure 5-4** Remove the print cartridge (2 of 2)



# External panels, covers, and doors

## Right cover

1. Remove the staple cassette (HP LaserJet M2727nfs only).

**Figure 5-5** Remove the right cover (1 of 4)



2. Use a small flatblade screwdriver to release three tabs at the rear of the product.

**Figure 5-6** Remove the right cover (2 of 4)

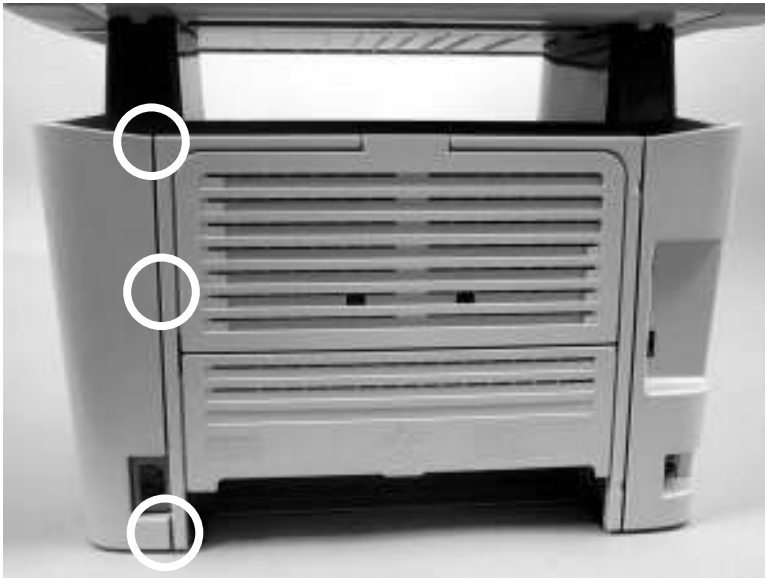

3. Release one tab at the bottom of the cover.

**Figure 5-7** Remove the right cover (3 of 4)

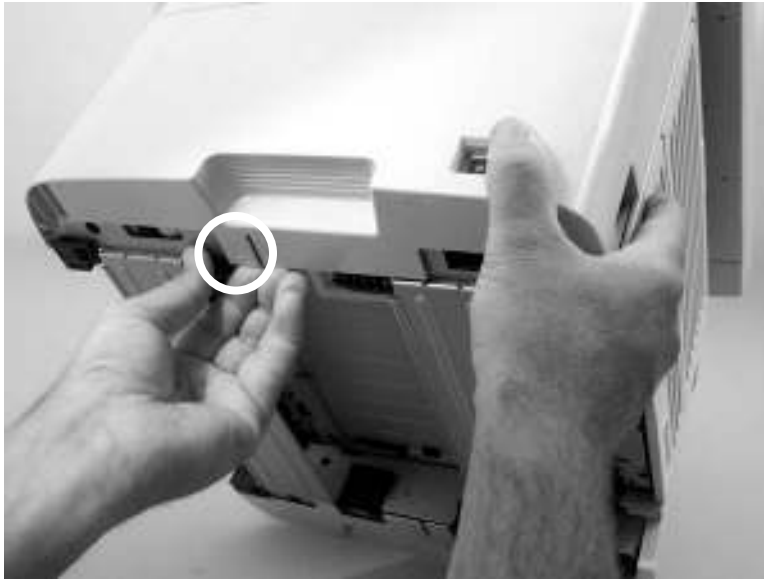

4. Rotate the back of the cover away from the product, and then slide it forward to remove it.

**Figure 5-8** Remove the right cover (4 of 4)



## Left cover

1. Use a small flatblade screwdriver to release two tabs at the rear of the product.

**Figure 5-9** Remove the left cover (1 of 3)



2. Release one tab at the bottom of the cover.

**Figure 5-10** Remove the left cover (2 of 3)

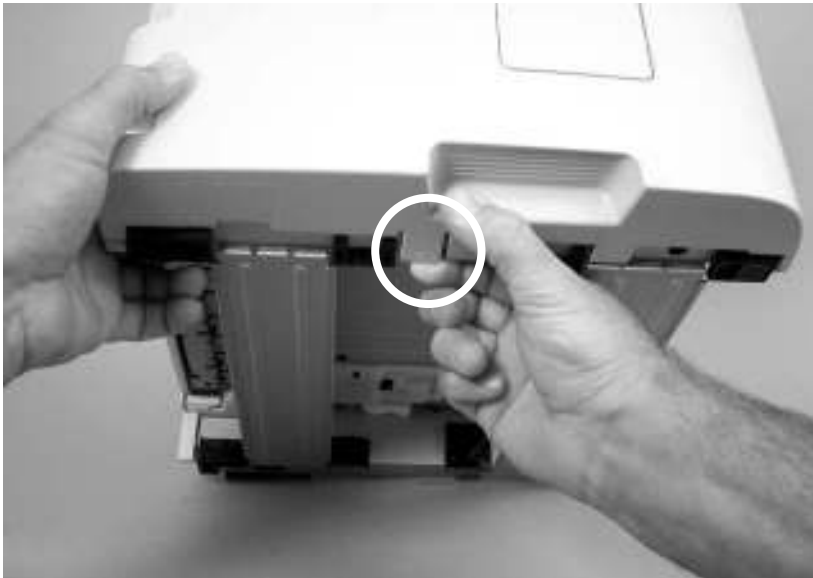

3. Rotate the back of the cover away from the product, and then slide it forward to remove it.

**Figure 5-11** Remove the left cover (3 of 3)

## Print-cartridge door

1. Remove the following components.
  - Right cover. See [Right cover on page 100](#).
  - Left cover. See [Left cover on page 102](#).
2. Open the print-cartridge door, and use a flatblade screwdriver to gently pry the cartridge-door arm (callout 1) off of the print-cartridge door.

---

△ **CAUTION:** Be careful not to break the tabs on the cartridge-door arm.

---

**Figure 5-12** Remove the print-cartridge door (1 of 3)

3. Close the print-cartridge door and remove two screws (callout 2).

**Figure 5-13** Remove the print-cartridge door (2 of 3)

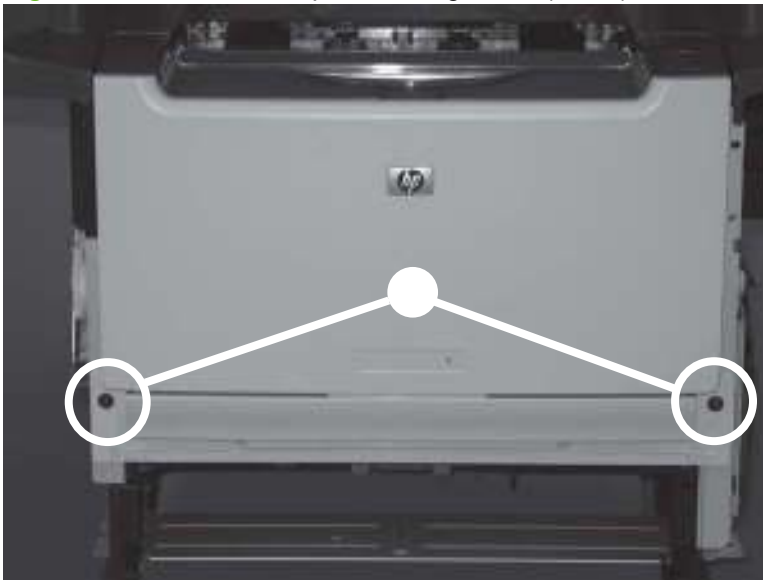

4. Lift the cartridge-door assembly up and straight away from the product.

**Figure 5-14** Remove the print-cartridge door (3 of 3)

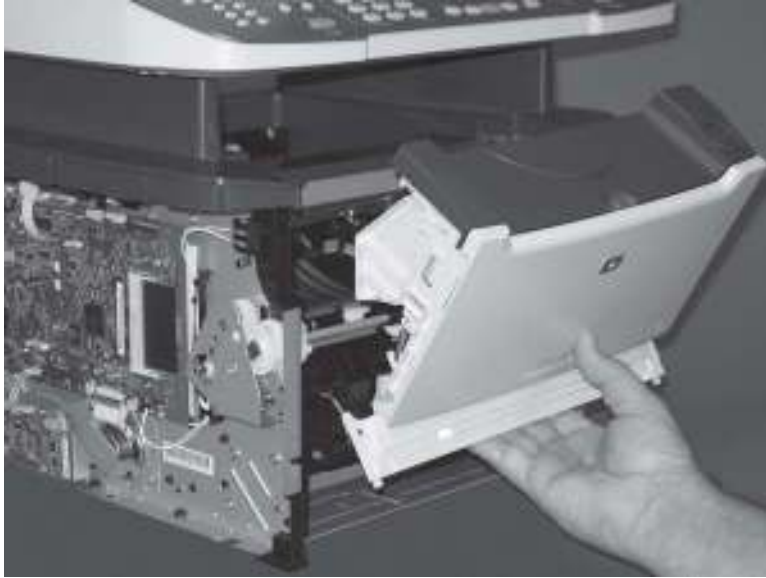

## Rear cover

1. Remove the following components.
  - Right cover. See [Right cover on page 100](#).
  - Left cover. See [Left cover on page 102](#).
2. Remove four screws (callout 1).

**Figure 5-15** Remove the rear cover (1 of 3)

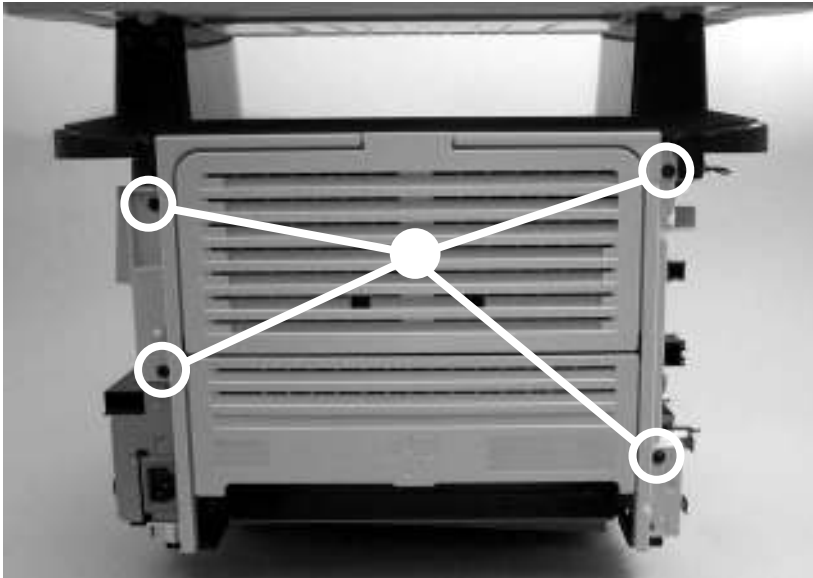

3. Use a small flatblade screwdriver to release the duplex-drive assembly hinge (callout 2) on the power-plug side of the assembly.

 **TIP:** Be careful to not bend the hinge. Straighten the hinge if necessary.

**Figure 5-16** Remove the rear cover (2 of 3)

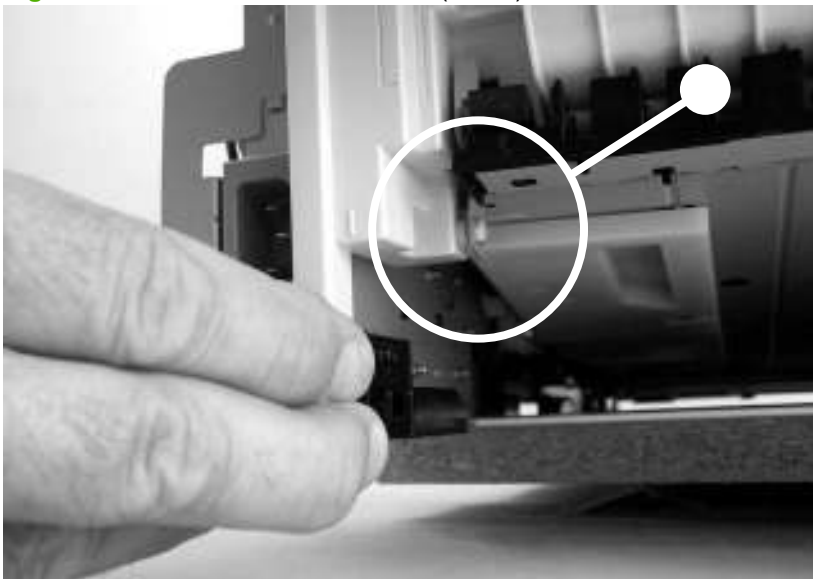



4. Use a small flatblade screwdriver to release the duplex-drive assembly hinge (callout 3) on the opposite side of the assembly from the power plug, and then separate the rear cover from the product.

---

 **TIP:** Be careful to not bend the hinge. Straighten the hinge if necessary.

---

**Figure 5-17** Remove the rear cover (3 of 3)

---

 **NOTE:** After removing the rear cover, the duplex assembly is disconnected at the rear of the product.

---

## Top cover

1. Remove the following components.
  - Right cover. See [Right cover on page 100](#).
  - Left cover. See [Left cover on page 102](#).
  - Rear cover. See [Rear cover on page 106](#).
  - Scanner/ADF assembly. See [Scanner/ADF assembly on page 117](#).
2. Open the print-cartridge door and loosen, but do *not* remove, one screw (callout 1).

**Figure 5-18** Remove the top cover (1 of 4)

3. Loosen, but do *not* remove, one screw (callout 2) on the opposite side.

**Figure 5-19** Remove the top cover (2 of 4)

4. Remove two screws (callout 3) from the back of the product.

**Figure 5-20** Remove the top cover (3 of 4)

5. Remove four screws (callout 4), and then lift up on the top cover (callout 5) to remove it.

**Figure 5-21** Remove the top cover (4 of 4)

## Replace the ADF pickup-roller assembly

1. Open the ADF cover.

**Figure 5-22** Replace the ADF pickup-roller assembly (1 of 6)



2. Release the ADF pickup-roller tension spring.

**Figure 5-23** Replace the ADF pickup-roller assembly (2 of 6)

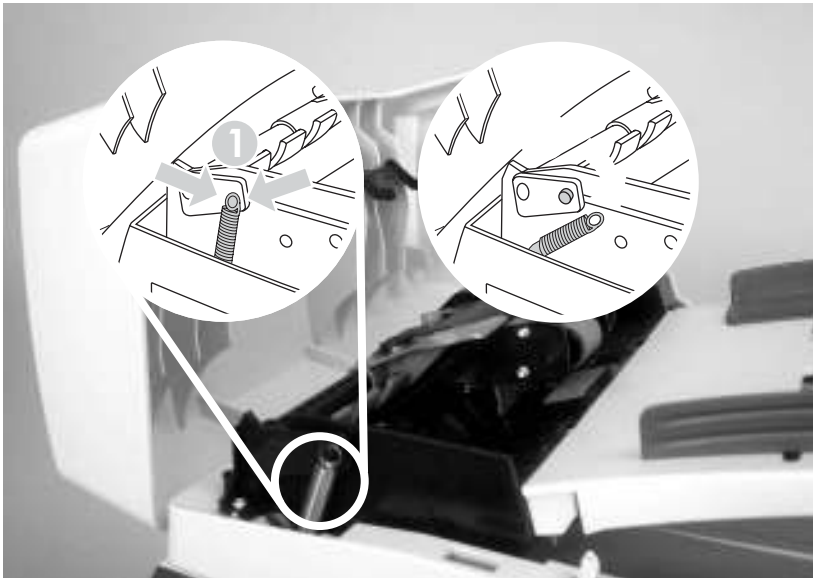

3. Push the pickup-roller assembly lever until the pickup-roller assembly snaps out of the chassis (callout 1), and then lift up the ADF pickup-roller assembly (callout 2).

**Figure 5-24** Replace the ADF pickup-roller assembly (3 of 6)

4. Rotate the end of the assembly away from the ADF (callout 3) and then slide it out of the ADF to remove the assembly (callout 4).

**Figure 5-25** Replace the ADF pickup-roller assembly (4 of 6)

5. Install the replacement assembly.

**Figure 5-26** Replace the ADF pickup-roller assembly (5 of 6)

6. Reattach the ADF pickup-roller tension spring, and then close the ADF cover.

**Figure 5-27** Replace the ADF pickup-roller assembly (6 of 6)

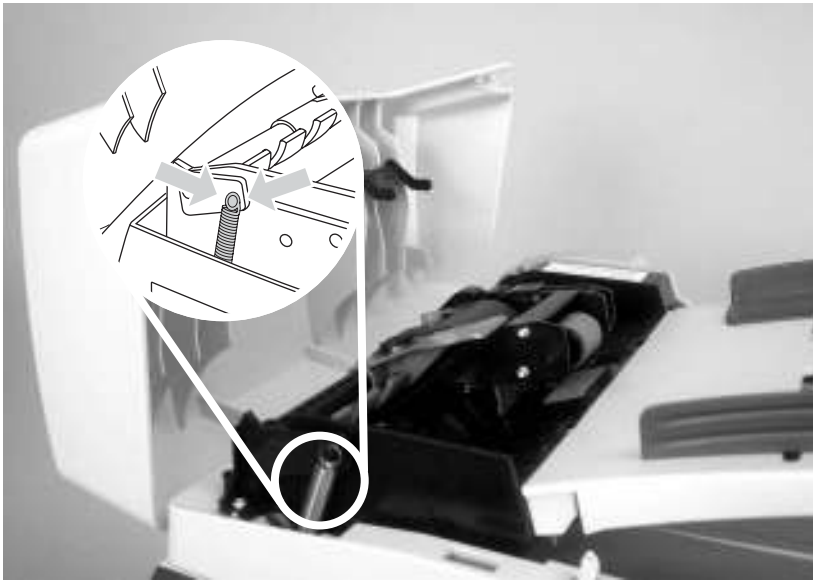

## ADF scanner glass

**CAUTION:** Avoid touching the flatbed glass or the ADF separation pad. Skin oils and fingerprints can contaminate the glass or pad and cause print-quality or paper-pickup problems.

1. Use a #10 torx screwdriver to remove one torx screw.

**Figure 5-28** Removing the ADF scanner glass (1 of 3)



2. Carefully remove the plastic ADF scanner-glass frame.

**Figure 5-29** Removing the ADF scanner glass (2 of 3)



3. Slide the black glass-locking lever toward the back of the product to release the glass, and then carefully remove the glass.

---

**CAUTION:** Avoid touching the flatbed glass or the ADF separation pad. Skin oils and fingerprints can contaminate the glass or pad and cause print-quality or paper-pickup problems.

---

**Figure 5-30** Removing the ADF scanner glass (3 of 3)





## ADF assembly

1. Open the scanner cover (it contains the ADF assembly).

**Figure 5-31** Remove the ADF assembly (1 of 3)



2. Squeeze the locking tabs on the ADF wire-harness plug (callout 1), and then disconnect the plug from the flatbed.

**Figure 5-32** Remove the ADF assembly (2 of 3)



3. Lift the scanner cover (containing the ADF assembly) straight up and off of the flatbed.

**Figure 5-33** Remove the ADF assembly (3 of 3)

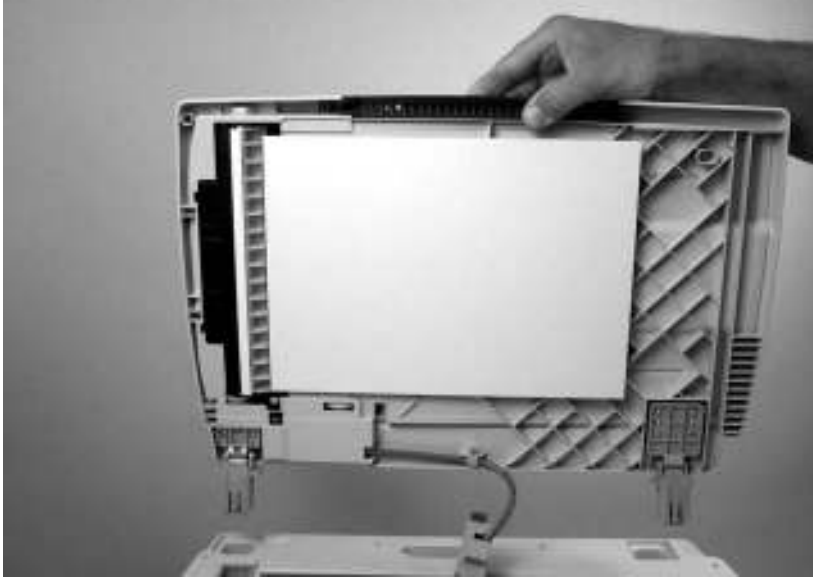

## Scanner/ADF assembly

1. Remove the left cover. See [Left cover on page 102](#).
2. Disconnect two FFC connectors (callout 1; J4 and J27), and two wire-harness connectors (callout 2; J2 and J36) from the formatter. Disconnect one ground-wire terminal lug (callout 3) from the product chassis.

**△ CAUTION:** Do not bend or fold the flat flexible cables (FFCs) during removal or installation. Also, do not straighten pre-folds in the FFCs. You *must* make sure that all FFCs are fully seated in their connectors. Failure to fully seat an FFC into a connector can cause a short circuit in a PCA.

**Figure 5-34** Remove the scanner/ADF assembly (1 of 4)

3. Remove one screw (callout 4) to remove the ferrite from the chassis (callout 5), and then feed the cables out through the ferrite.

**Figure 5-35** Remove the scanner/ADF assembly (2 of 4)

4. Remove four screws (callout 6).

**Figure 5-36** Remove the scanner/ADF assembly (3 of 4)

5. Slide the scanner/ADF assembly toward the front of the base unit, and then lift it up to remove it.

**WARNING!** The scanner cover (which contains the ADF assembly) is not captive when the scanner assembly is removed. The scanner cover can suddenly open and be damaged when you are handling the scanner assembly. You *must* keep the scanner assembly level to make sure that the scanner cover (ADF assembly) does not open.

**CAUTION:** Make sure that you carefully pass the scanner wire harnesses through the opening in the top cover. The connectors can be damaged if they become caught on the top cover.

**Figure 5-37** Remove the scanner/ADF assembly (4 of 4)



## Bezel and control panel

1. Gently pry up on the corner of the control-panel bezel, and then carefully lift it up and off of the control panel to remove it.

 **NOTE:** If you are only replacing the bezel, you can disregard the remaining steps in this procedure. Use the following steps if you are also replacing the control panel.

**Figure 5-38** Remove the bezel and control panel (1 of 4)



2. Remove one screw (callout 1).

**Figure 5-39** Remove the bezel and control panel (2 of 4)



3. Use a small flatblade screwdriver to release the three locking tabs (callout 2) along the top of the control panel.

**Figure 5-40** Remove the bezel and control panel (3 of 4)



4. Turn the control panel over and disconnect one FFC (callout 3).

**CAUTION:** Do not bend or fold the flat flexible cables (FFCs) during removal or installation. Also, do not straighten pre-folds in the FFCs. You *must* make sure that all FFCs are fully seated in their connectors. Failure to fully seat an FFC into a connector can cause a short circuit in a PCA.

**Figure 5-41** Remove the bezel and control panel (4 of 4)



**TIP:** When you reinstall the control panel, make sure that the tabs at the bottom of the panel (callout 4) fit underneath the retainers in the scanner body.

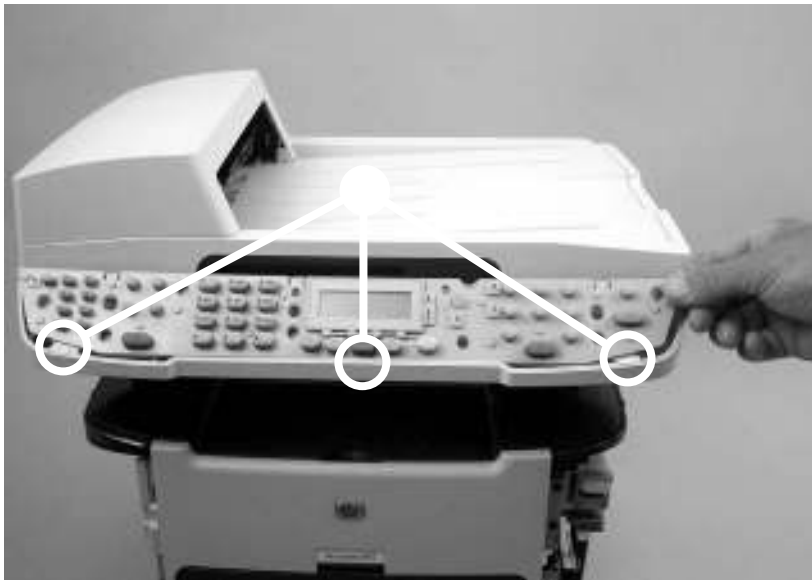

## Internal assemblies

### Convenience-stapler assembly (HP LaserJet M2727nfs only)

1. Remove the right cover. See [Right cover on page 100](#).
2. Disconnect one connector (callout 1).

**Figure 5-42** Remove the convenience-stapler assembly (1 of 2)

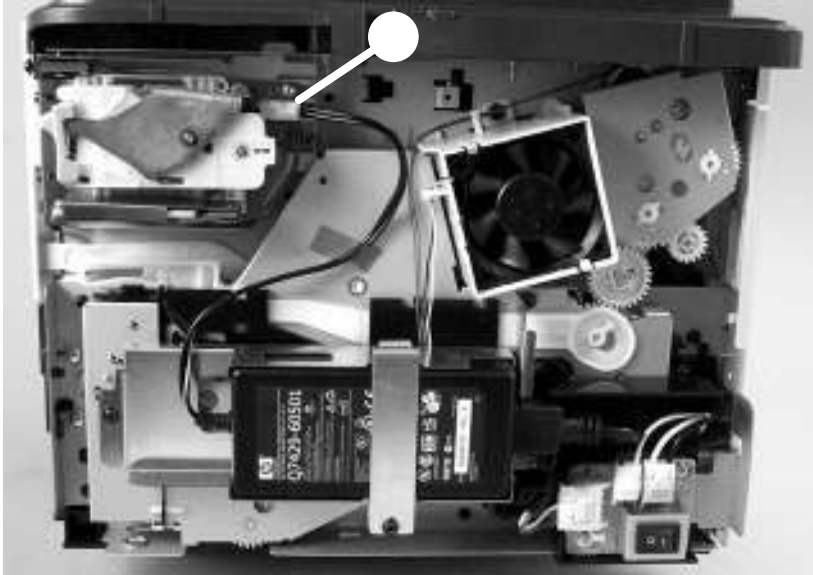



3. Remove two screws (callout 2), and then separate the stapler assembly from the chassis to remove it.

**Figure 5-43** Remove the convenience-stapler assembly (2 of 2)



 **TIP:** When you reinstall the convenience-stapler assembly, make sure that the hook on the top of the assembly bracket fits into the slot on the product chassis.



## Convenience-stapler power supply (HP LaserJet M2727nfs only)

1. Remove the right cover. See [Right cover on page 100](#).
2. Disconnect one connector (callout 1) at the convenience-stapler assembly, and then remove one screw (callout 2).

**Figure 5-44** Remove the convenience-stapler power assembly (1 of 3)

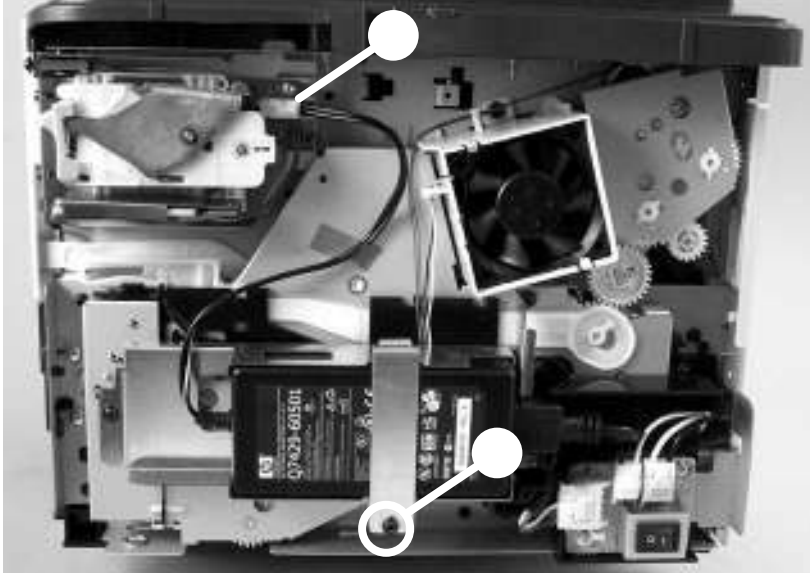

3. Remove the sheet-metal strap, and then separate the convenience-stapler power supply from the chassis.

**Figure 5-45** Remove the convenience-stapler power assembly (2 of 3)



4. Disconnect one connector and then remove the convenience-stapler power supply.

**Figure 5-46** Remove the convenience-stapler power assembly (3 of 3)



## Convenience-stapler AC inlet cable (HP LaserJet M2727nfs only)

1. Remove the right cover. See [Right cover on page 100](#).
2. Disconnect two connectors (callout 1) to remove the convenience-stapler AC inlet cable.

**Figure 5-47** Remove the convenience-stapler AC inlet cable

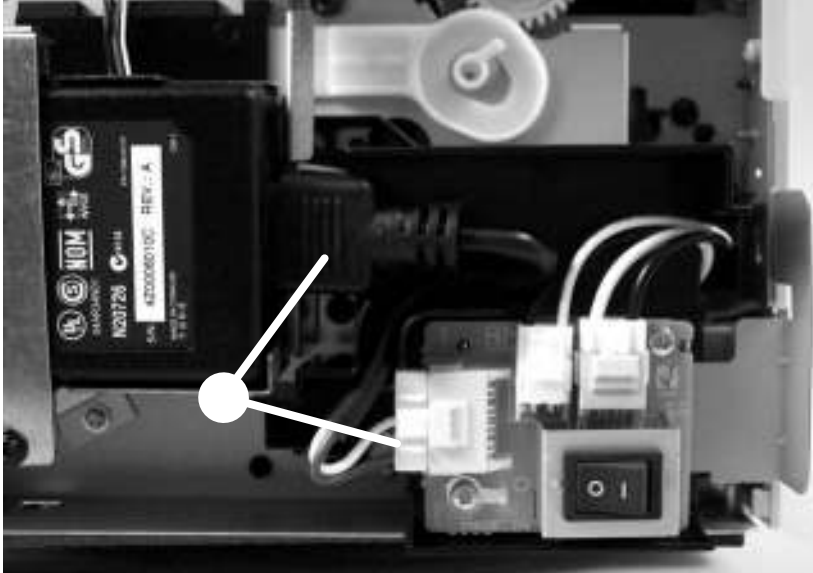

## Convenience-stapler power supply bracket and strap (HP LaserJet M2727nfs only)

1. Remove the following components.
    - Right cover. See [Right cover on page 100](#).
    - Convenience-stapler power supply (HP LaserJet M2727nfs only). See [Convenience-stapler power supply \(HP LaserJet M2727nfs only\) on page 124](#).
- 
-  **NOTE:** When you remove the convenience-stapler power supply, you also remove the sheet-metal strap.
- 
2. Remove three screws (callout 1), and then separate the sheet-metal bracket (callout 2) from the product chassis to remove it.

**Figure 5-48** Remove the convenience-stapler bracket and strap

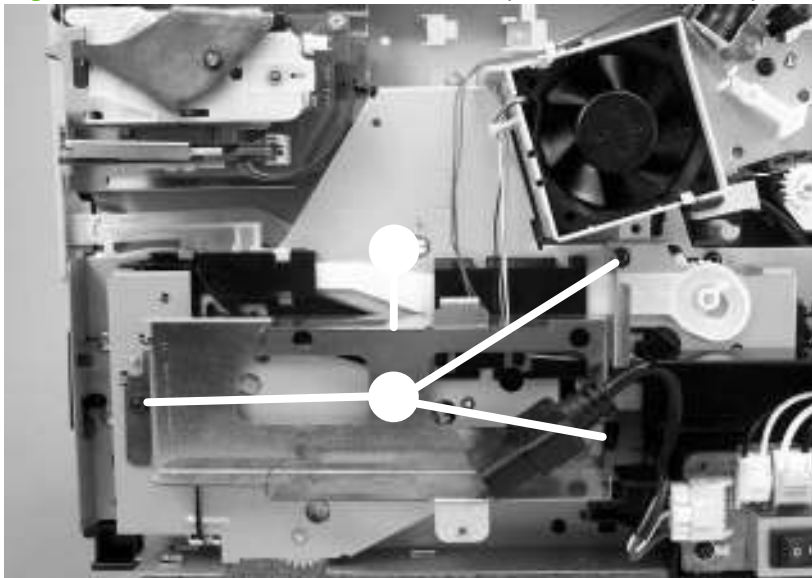

## Speaker

1. Remove the left cover. See [Left cover on page 102](#).
2. Disconnect one FFC (callout 1; J2) from the fax card, remove three screws (callout 2), and remove the fax card (callout 3).



**CAUTION:** PCAs are sensitive to electrostatic discharge (ESD). Look for the ESD reminder when removing PCAs. Always perform service work at an ESD-protected workstation or mat. If an ESD workstation or mat is not available, ground yourself by touching the sheet-metal chassis *before* touching an ESD-sensitive part.

Protect the ESD-sensitive parts by placing them in ESD pouches when they are out of the product.

**CAUTION:** Do not bend or fold the flat flexible cables (FFCs) during removal or installation. Also, do not straighten pre-folds in the FFCs. You *must* make sure that all FFCs are fully seated in their connectors. Failure to fully seat an FFC into a connector can cause a short circuit in a PCA.

**Figure 5-49** Remove the speaker (1 of 2)

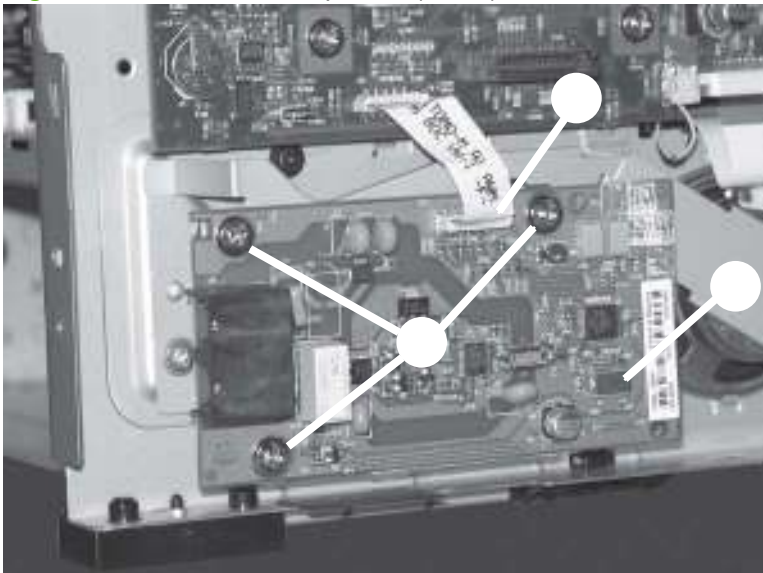

3. Remove one screw (callout 4) and the metal plate (callout 5).

4. Disconnect one connector (callout 6), and then separate the speaker (callout 7) from the product.

**Figure 5-50** Remove the speaker (2 of 2)

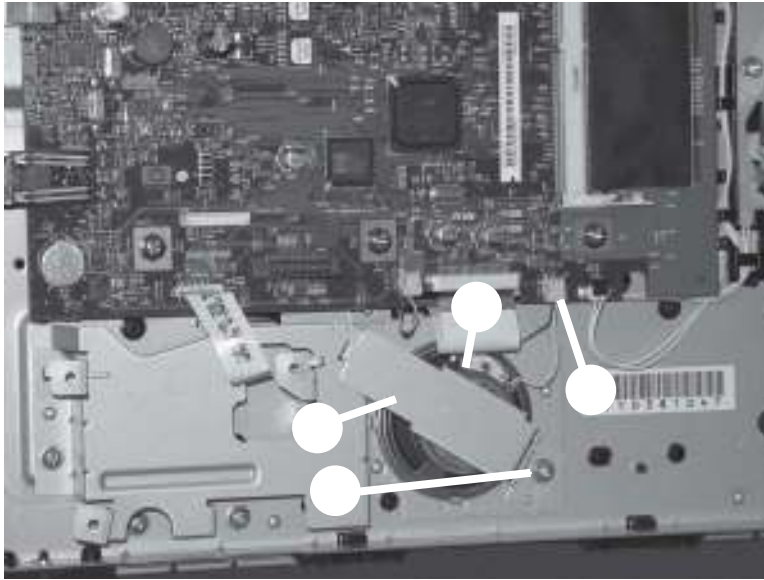

## Power-switch PCA

1. Remove the right cover. See [Right cover on page 100](#).
2. Disconnect two connectors (callout 1), and then remove two screws (callout 2).

 **NOTE:** For the HP LaserJet M2727nfs, disconnect one additional connector (callout 3).

3. Separate the power-switch PCA (callout 4) from the product.



**CAUTION:** PCAs are sensitive to electrostatic discharge (ESD). Look for the ESD reminder when removing PCAs. Always perform service work at an ESD-protected workstation or mat. If an ESD workstation or mat is not available, ground yourself by touching the sheet-metal chassis *before* touching an ESD-sensitive part.

Protect the ESD-sensitive parts by placing them in ESD pouches when they are out of the product.

**Figure 5-51** Remove the power-switch PCA (HP LaserJet M2727nfs shown)

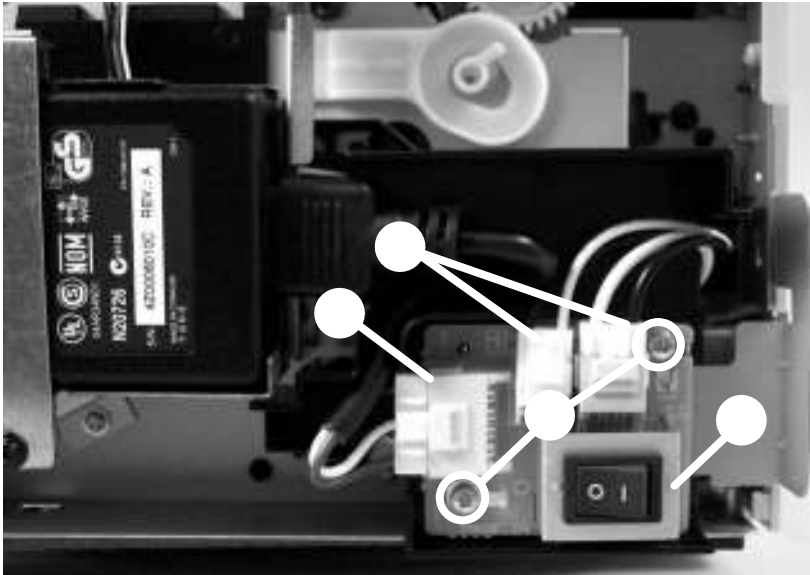



4. If you need to remove the power-switch PCA mounting bracket, remove two screws (callout 5), then separate the power-switch PCA mounting bracket from the product.

**Figure 5-52** Remove the power-switch PCA mounting bracket

## Formatter

---



**CAUTION:** PCAs are sensitive to electrostatic discharge (ESD). Look for the ESD reminder when removing PCAs. Always perform service work at an ESD-protected workstation or mat. If an ESD workstation or mat is not available, ground yourself by touching the sheet-metal chassis *before* touching an ESD-sensitive part.

Protect the ESD-sensitive parts by placing them in ESD pouches when they are out of the product.

**CAUTION:** Do not bend or fold the flat flexible cables (FFCs) during removal or installation. Also, do not straighten pre-folds in the FFCs. You *must* make sure that all FFCs are fully seated in their connectors. Failure to fully seat an FFC into a connector can cause a short circuit in a PCA.

---

1. Remove the left cover. See [Left cover on page 102](#).
2. Disconnect five connectors (callout 1; GND wire lug, J36, J2, J32, J34) and five FFCs (callout 2; J4, J27, J28, J31, J26).

**Figure 5-53** Remove the formatter (1 of 5)

3. Remove six screws (callout 3), and then separate the formatter from the product.

**Figure 5-54** Remove the formatter (2 of 5)

---

**CAUTION:** Make sure that you install the protective sheet behind the formatter when you reinstall it. Failure to install the protective sheet might cause a short circuit and damage the formatter.

---

**Figure 5-55** Install formatter protective sheet

4. **For products that use an Asian character control panel only:** use a pair of needle nose pliers to release the Asian-character control-panel-display PCA spacer from the formatter.

**Figure 5-56** Remove the formatter (3 of 4)

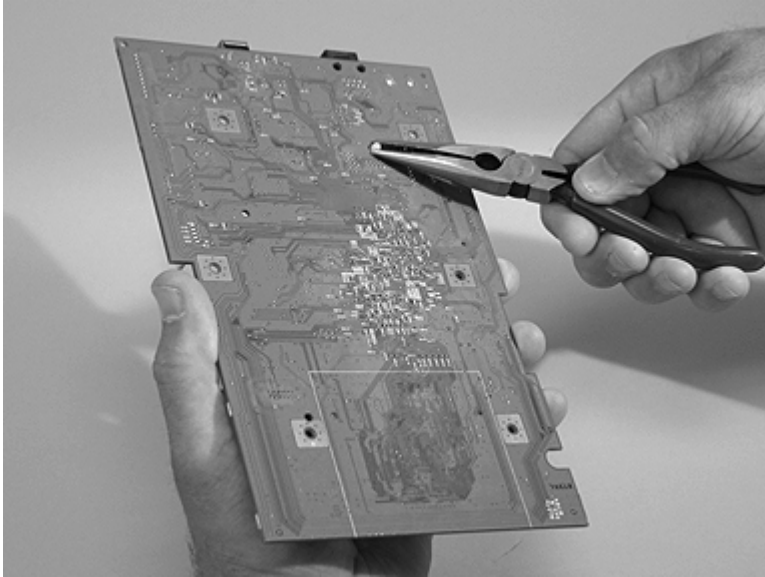

5. **For products that use an Asian character control panel only:** remove the Asian-character control-panel-display PCA from the formatter. Install the PCA on the replacement formatter (connector H3).

**Figure 5-57** Remove the formatter (4 of 4)

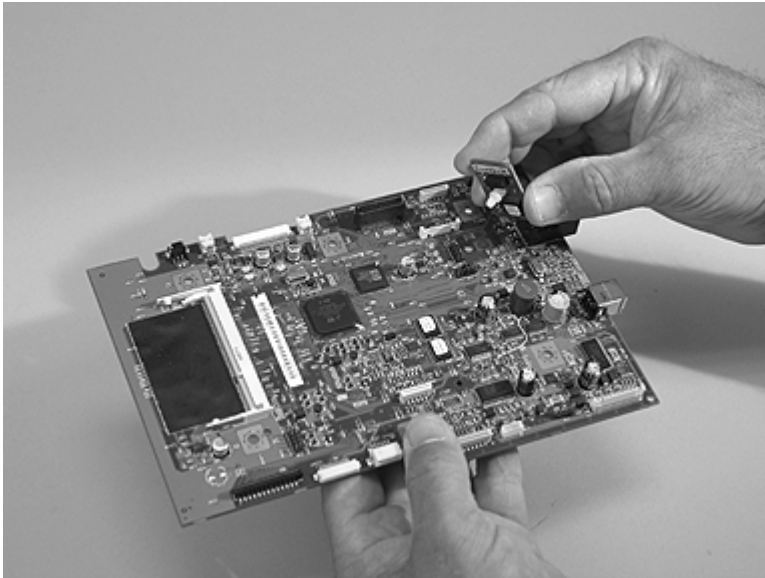

## Duplex assembly

1. Remove the following components.
  - Right cover. See [Right cover on page 100](#).
  - Left cover. See [Left cover on page 102](#).
  - Rear cover. See [Rear cover on page 106](#).

---

 **NOTE:** After removing the rear cover, the duplex assembly is disconnected at the rear of the product.

---

2. Push down on the green lever at the front of the product to unlock and lower the duplex assembly.

**Figure 5-58** Remove the duplex assembly (1 of 2)

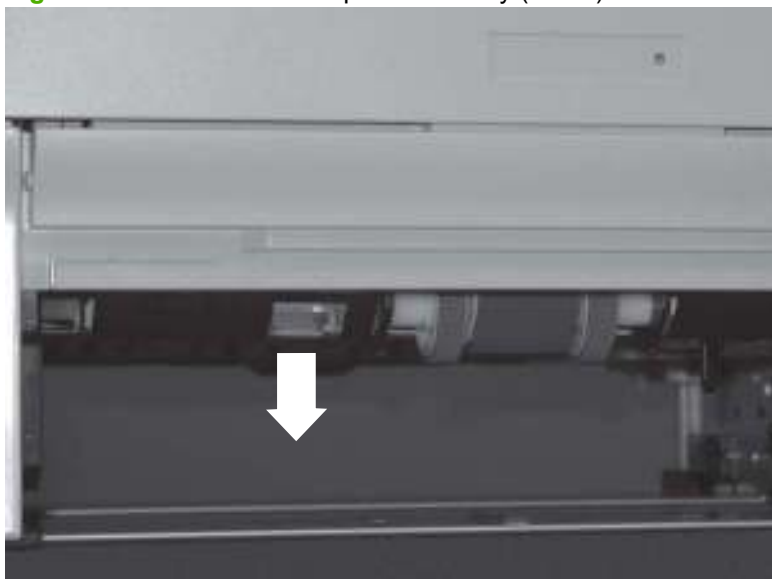

3. Pull the duplex assembly out through the rear of the product.

**Figure 5-59** Remove the duplex assembly (2 of 2)

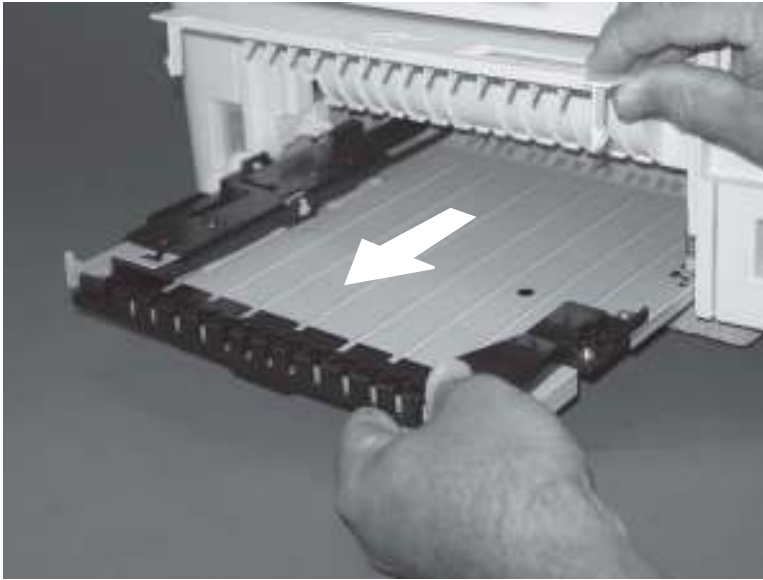

 **TIP:** When you reinstall the duplex assembly, push the size-selection switch in or pull the size-selection switch out to correctly set the media size that is used in your country/region.

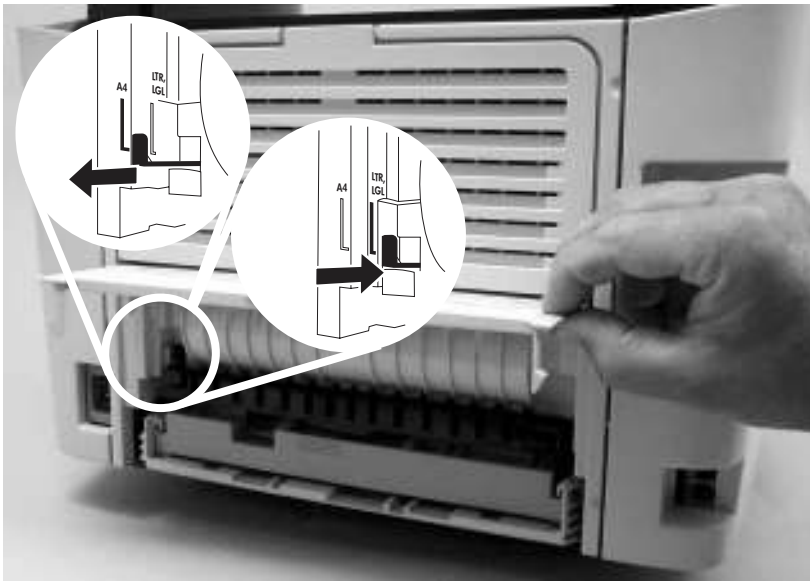

## Laser/scanner (print engine)

---



**CAUTION:** PCAs are sensitive to electrostatic discharge (ESD). Look for the ESD reminder when removing PCAs. Always perform service work at an ESD-protected workstation or mat. If an ESD workstation or mat is not available, ground yourself by touching the sheet-metal chassis *before* touching an ESD-sensitive part.

Protect the ESD-sensitive parts by placing them in ESD pouches when they are out of the product.

**CAUTION:** Do not bend or fold the flat flexible cables (FFCs) during removal or installation. Also, do not straighten pre-folds in the FFCs. You *must* make sure that all FFCs are fully seated in their connectors. Failure to fully seat an FFC into a connector can cause a short circuit in a PCA.

---

1. Remove the following components.
  - Right cover. See [Right cover on page 100](#).
  - Left cover. See [Left cover on page 102](#).
  - Rear cover. See [Rear cover on page 106](#).
  - Scanner/ADF assembly. See [Scanner/ADF assembly on page 117](#).
  - Top cover. See [Top cover on page 108](#).
2. Disconnect one FFC (callout 1) from the laser/scanner PCA.
3. Disconnect one connector (callout 2) from the top of the laser/scanner.
4. Remove all of the wire harnesses (callout 3) from the retainers.

---

 **NOTE:** Examine the cable routing as you remove the wire harnesses.

---

5. Remove four screws (callout 4).

**Figure 5-60** Remove the laser/scanner assembly

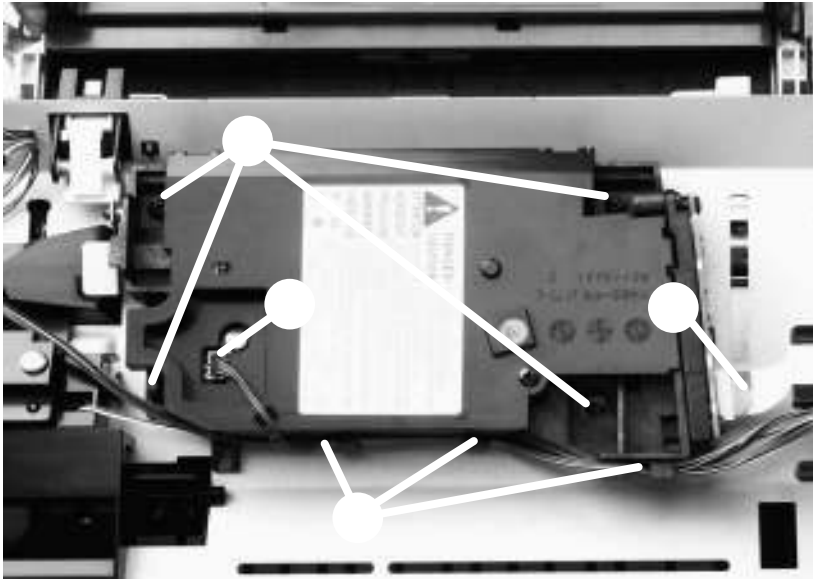

6. Lift the laser/scanner out of the product.

---

 **NOTE:** Examine the shutter switch placement as you lift the laser/scanner out of the product.

---



## Memory-tag-reader assembly (E-label reader)

1. Remove the following components.
  - Right cover. See [Right cover on page 100](#).
  - Left cover. See [Left cover on page 102](#).
  - Rear cover. See [Rear cover on page 106](#).
  - Scanner/ADF assembly. See [Scanner/ADF assembly on page 117](#).
  - Top cover. See [Top cover on page 108](#).
2. Remove the fan from the product chassis (see step 3 of [Fan on page 141](#)).
3. Remove one cable (callout 1) from the cable holder on top of the memory-tag-reader cover.
4. Disconnect one cable from the formatter (callout 2).

**Figure 5-61** Remove the memory-tag-reader assembly (1 of 2)

5. Remove all of the wire harnesses (callout 3) from the retainers.

---

 **NOTE:** Examine the cable routing as you remove the wire harnesses.

---

6. Remove one screw (callout 4).

---

☞ **TIP:** When you reinstall the memory-tag-reader assembly, make sure that the front of the assembly is under the laser/scanner shutter (callout 5).

---

**Figure 5-62** Remove the memory-tag-reader assembly (2 of 2)

7. Lift up slightly the back of the memory-tag-reader assembly, and then slide the assembly toward the back of the product to release it from the laser/scanner plate.

---

☞ **TIP:** The spring is not attached to the memory-tag-reader assembly (callout 6). Do *not* lose this spring.

---

**Figure 5-63** Memory-tag-reader assembly spring

## Fan

1. Remove the following components.
  - Right cover. See [Right cover on page 100](#).
  - Left cover. See [Left cover on page 102](#).
  - Rear cover. See [Rear cover on page 106](#).
  - Scanner/ADF assembly. See [Scanner/ADF assembly on page 117](#).
  - Top cover. See [Top cover on page 108](#).
  - Convenience-stapler power supply. See [Convenience-stapler power supply \(HP LaserJet M2727nfs only\) on page 124](#).
  - Convenience-stapler power supply bracket. See [Convenience-stapler power supply bracket and strap \(HP LaserJet M2727nfs only\) on page 127](#).
  - Power-switch PCA and mounting bracket. See [Power-switch PCA on page 130](#)
2. Disconnect one connector (callout 1; J209) at the ECU and feed the wire harness through the hole in the chassis (behind the power-switch PCA).

**Figure 5-64** Remove the fan (1 of 2)



3. Remove two screws (callout 2), and then lift the fan off of the product.

**Figure 5-65** Remove the fan (2 of 2)

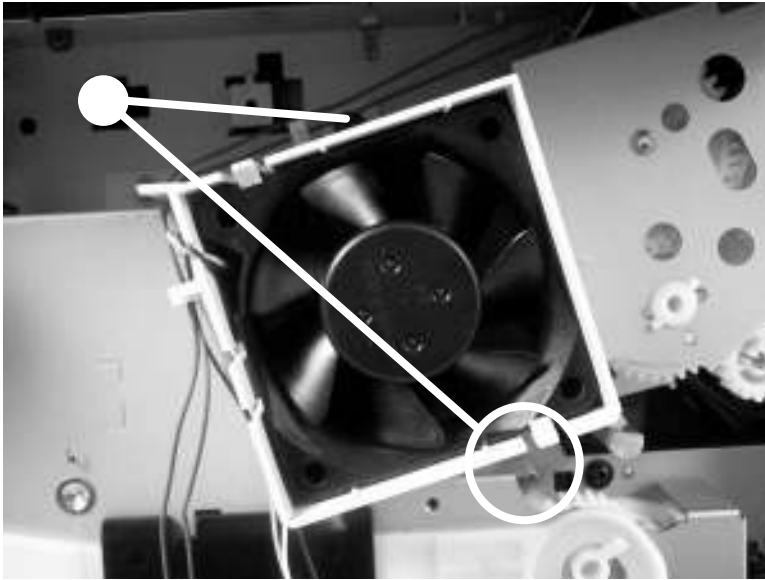

## Duplex-drive gears

1. Remove the following components.
  - Right cover. See [Right cover on page 100](#).
  - Left cover. See [Left cover on page 102](#).
  - Rear cover. See [Rear cover on page 106](#).
  - Scanner/ADF assembly. See [Scanner/ADF assembly on page 117](#).
  - Top cover. See [Top cover on page 108](#).
  - Convenience-stapler power supply (HP LaserJet M2727nfs only). See [Convenience-stapler power supply \(HP LaserJet M2727nfs only\) on page 124](#).
  - Convenience-stapler bracket and strap (HP LaserJet M2727nfs only). See [Convenience-stapler power supply bracket and strap \(HP LaserJet M2727nfs only\) on page 127](#).
  - Fan. See [Fan on page 141](#).

2. Remove three screws (callout 1), and then lift the assembly away from the product.

 **NOTE:** The gears are not attached to the gear plate. Carefully remove the gear plate and the gears together to prevent them from falling out of the assembly. If the gears are separated from the assembly, see [Figure 5-67 Replace the duplex-drive gears on page 144](#) to correctly reinstall them.

**Figure 5-66** Remove the duplex-drive gears

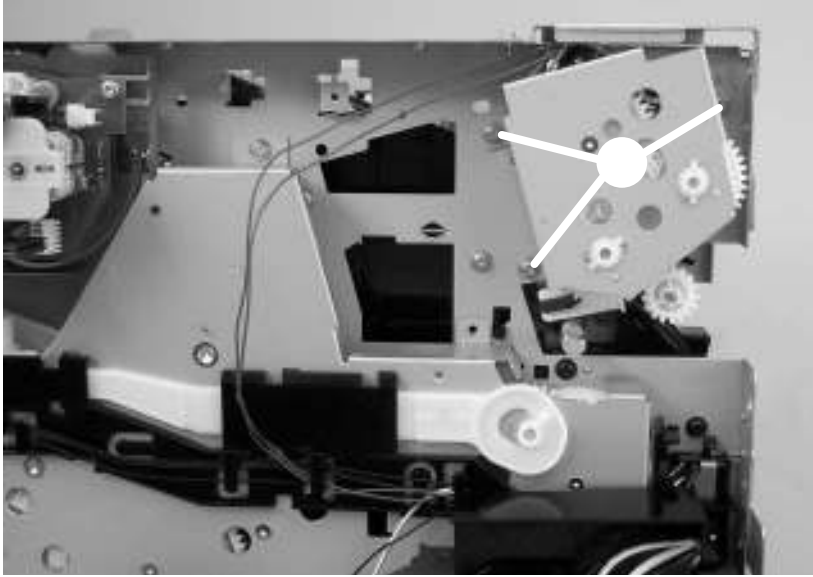

 **TIP:** It might be easier to replace the assembly if you place the two large gear sets into the appropriate holes on the chassis first, and then line up the holes in the gear plate with the gears as you replace the plate.

**Figure 5-67** Replace the duplex-drive gears

## Duplex solenoid

1. Remove the following components.
  - Right cover. See [Right cover on page 100](#).
  - Left cover. See [Left cover on page 102](#).
  - Rear cover. See [Rear cover on page 106](#).
  - Scanner/ADF assembly. See [Scanner/ADF assembly on page 117](#).
  - Top cover. See [Top cover on page 108](#).
  - Convenience-stapler power supply (HP LaserJet M2727nfs only). See [Convenience-stapler power supply \(HP LaserJet M2727nfs only\) on page 124](#).
  - Convenience-stapler bracket and strap (HP LaserJet M2727nfs only). See [Convenience-stapler power supply bracket and strap \(HP LaserJet M2727nfs only\) on page 127](#).
  - Fan. See [Fan on page 141](#).
  - Duplex-drive gears. See [Duplex-drive gears on page 143](#).
2. Disconnect one connector (callout 1; J211) at the ECU. Feed the wire harness out of the product and wire-harness guides.

**Figure 5-68** Remove the duplex solenoid (1 of 2)

3. Remove one screw (callout 2), and then lift the solenoid off of the product chassis.

 **NOTE:** The solenoid lever (callout 3) is not retained. Do *not* lose this lever.

---

**Figure 5-69** Remove the duplex solenoid (2 of 2)

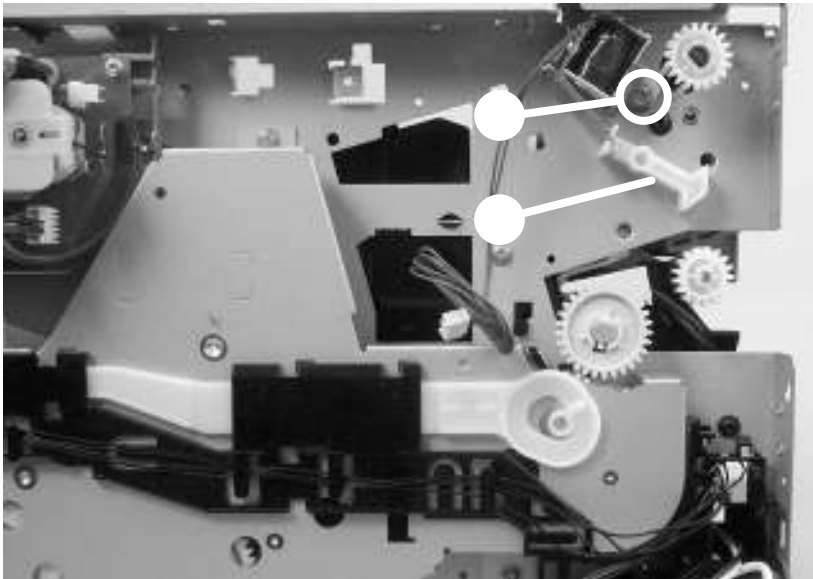



## Fuser

1. Remove the following components.
  - Right cover. See [Right cover on page 100](#).
  - Left cover. See [Left cover on page 102](#).
  - Rear cover. See [Rear cover on page 106](#).
  - Scanner/ADF assembly. See [Scanner/ADF assembly on page 117](#).
  - Top cover. See [Top cover on page 108](#).
  - Convenience-stapler power supply (HP LaserJet M2727nfs only). See [Convenience-stapler power supply \(HP LaserJet M2727nfs only\) on page 124](#).
  - Convenience-stapler bracket and strap (HP LaserJet M2727nfs only). See [Convenience-stapler power supply bracket and strap \(HP LaserJet M2727nfs only\) on page 127](#).
  - Power-switch PCA. See [Power-switch PCA on page 130](#).
  - Formatter. See [Formatter on page 132](#).
  - Duplex assembly. See [Duplex assembly on page 135](#).
  - Fan. See [Fan on page 141](#).
  - Duplex-drive gears. See [Duplex-drive gears on page 143](#).
  - Duplex solenoid. See [Duplex solenoid on page 145](#).
2. On the right side of the product, press the tabs on two gears (callout 1) to release the gears, and then slide the gears off of the shafts.

**Figure 5-70** Remove the fuser (1 of 9)

3. Disconnect the connectors along the edge of the ECU (callout 2). Remove the wire harness from the guides (callout 3).

**Figure 5-71** Remove the fuser (2 of 9)

4. Remove one screw (callout 4) from the wire harness guide and separate it from the product.

---

 **Reinstallation tip** You might find it easier to reassemble the wire harnesses and the wire harness holder if you put the smaller wires in place first.

---

**Figure 5-72** Remove the fuser (3 of 9)

5. Disconnect four connectors (callout 5).

**Figure 5-73** Remove the fuser (4 of 9)

6. Remove one screw (callout 8) on the wire guide that contains the optional tray 3 connector.

---

 **NOTE:** It is not necessary to remove the tray 3 connector or the wire harness guide. But you need to release the guide so that the tray 3 connector wire harness is loose enough to be removed from a guide on the fuser later in this procedure.

---

**Figure 5-74** Remove the fuser (5 of 9)

7. Remove three screws (callout 9) from the right side of the product.

**Figure 5-75** Remove the fuser (6 of 9)

8. Remove three screws (callout 10) from the left side of the product.

**Figure 5-76** Remove the fuser (7 of 9)

9. Pull on the product chassis at the top to spread the product frame and release the fuser from the frame.

**Figure 5-77** Remove the fuser (8 of 9)



10. Pull the fuser out of the product at an angle so that the delivery-roller shaft clears the hole (callout 11) in the chassis. Carefully remove the wire harnesses from the guide in the lower-left corner of the fuser.

**Figure 5-78** Remove the fuser (9 of 9)

## Interlock assembly

1. Remove the following components.
  - Right cover. See [Right cover on page 100](#).
  - Left cover. See [Left cover on page 102](#).
  - Rear cover. See [Rear cover on page 106](#).
  - Scanner/ADF assembly. See [Scanner/ADF assembly on page 117](#).
  - Top cover. See [Top cover on page 108](#).
2. Remove two screws (callout 1), lift the interlock assembly away from the product, and then disconnect two connectors (callout 2).

**Figure 5-79** Remove the interlock assembly

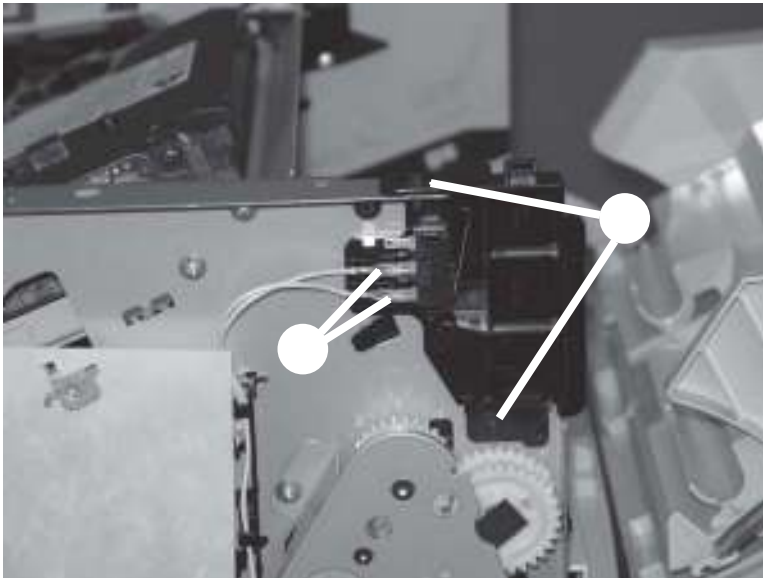

## Engine controller assembly (ECU)

---



**CAUTION:** PCAs are sensitive to electrostatic discharge (ESD). Look for the ESD reminder when removing PCAs. Always perform service work at an ESD-protected workstation or mat. If an ESD workstation or mat is not available, ground yourself by touching the sheet-metal chassis *before* touching an ESD-sensitive part.

Protect the ESD-sensitive parts by placing them in ESD pouches when they are out of the product.

**CAUTION:** Do not bend or fold the flat flexible cables (FFCs) during removal or installation. Also, do not straighten pre-folds in the FFCs. You *must* make sure that all FFCs are fully seated in their connectors. Failure to fully seat an FFC into a connector can cause a short circuit in a PCA.

---

1. Remove the following components.
  - Right cover. See [Right cover on page 100](#).
  - Left cover. See [Left cover on page 102](#).
  - Rear cover. See [Rear cover on page 106](#).
  - Scanner/ADF assembly. See [Scanner/ADF assembly on page 117](#).
  - Top cover. See [Top cover on page 108](#).
  - Power-switch PCA and mounting bracket. See [Power-switch PCA on page 130](#)
  - Formatter. See [Formatter on page 132](#).
  - Duplex assembly. See [Duplex assembly on page 135](#).
  - Fan. See [Fan on page 141](#).
  - Duplex-drive gears. See [Duplex-drive gears on page 143](#).
  - Fuser. See [Fuser on page 147](#).
  - Interlock assembly. See [Interlock assembly on page 152](#).

2. Remove the wire harnesses from the retainer under the feed plate (callout 1), and then remove the feed plate by lifting it and pulling it straight back.

**Figure 5-80** Remove the ECU (1 of 7)

3. Disconnect three connectors (callout 2).

**Figure 5-81** Remove the ECU (2 of 7)

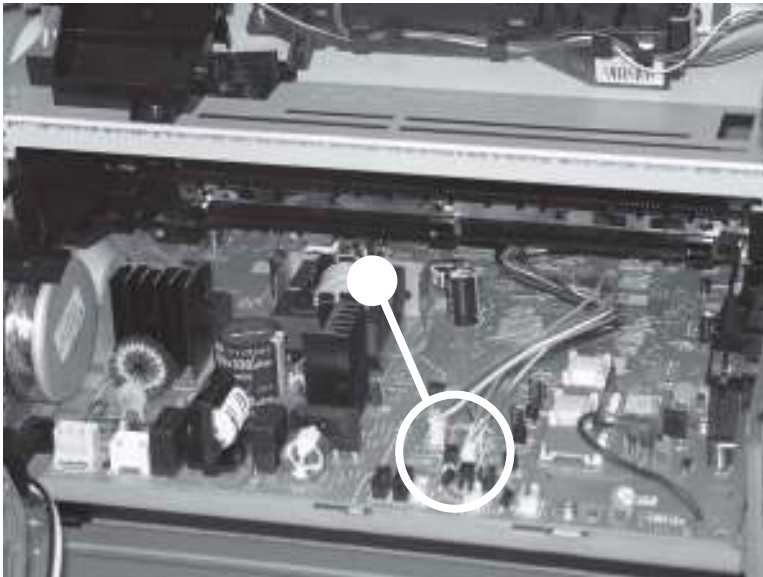



4. Remove one screw (callout 3).

**Figure 5-82** Remove the ECU (3 of 7)

5. Remove two screws (callout 4) from the left side of the product. Unlace the interlock cables from the wire harness, and then push the interlock cables and the formatter cable (callout 5) through the hole in the chassis.

**Figure 5-83** Remove the ECU (4 of 7)



6. Spread the product frame on one side of the product to release the internal tabs that secure the ECU to the chassis.

**Figure 5-84** Remove the ECU (5 of 8)



7. Spread the product frame on the other side of the product to release the internal tabs, and then lower the ECU slightly and pull it straight back to remove it.

---

 **NOTE:** Make sure that wire harnesses do not become caught on the contact springs as you remove the ECU.

---

**Figure 5-85** Remove the ECU (6 of 7)



---

 **Reinstallation tip** When replacing the ECU, you might find it easier to find the correct placement of the ECU pan in the product if you tip the product so that it rests on its front.

---

8. Remove four screws (callout 7), and then lift the ECU off of the ECU pan.

**Figure 5-86** Remove the ECU (7 of 7)

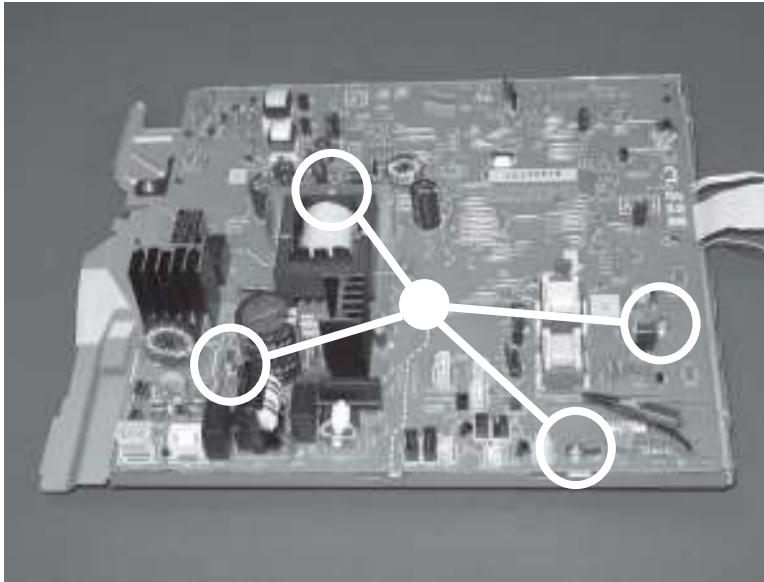

## Main motor

1. Remove the following components.
  - Right cover. See [Right cover on page 100](#).
  - Left cover. See [Left cover on page 102](#).
  - Rear cover. See [Rear cover on page 106](#).
  - Scanner/ADF assembly. See [Scanner/ADF assembly on page 117](#).
  - Top cover. See [Top cover on page 108](#).
  - Formatter. See [Formatter on page 132](#).
  - Fan. See [Fan on page 141](#).
  - Duplex-drive gears. See [Duplex-drive gears on page 143](#).
  - Interlock assembly. See [Interlock assembly on page 152](#).
  - ECU. See [Engine controller assembly \(ECU\) on page 153](#).
2. Remove three screws (callout 1).

**Figure 5-87** Remove the main motor (1 of 2)



3. Hold the motor while releasing the tabs (callout 2) on the wire-harness guide, and then lift the motor and the guide out of the product together.

**Figure 5-88** Remove the main motor (2 of 2)

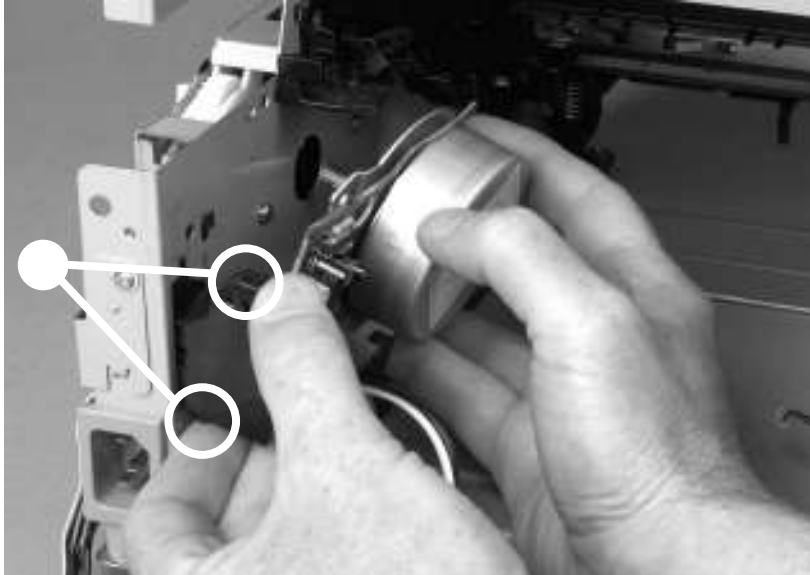

## Pickup-and-feed assemblies

This section covers the major assemblies of the pickup-and-feed system: the transfer roller and the registration assembly.

For information about replacing the tray 2 pickup roller, see [Replace the tray 2 pickup roller on page 40](#).

For information about replacing the tray 2 or tray 3 separation pad, see [Replace the tray 2 and optional tray 3 separation pad on page 45](#).

For information about replacing the ADF pickup roller, see [Replace the ADF pickup-roller assembly on page 110](#).

### Transfer roller

 **NOTE:** Make sure that the transfer roller needs to be replaced before you remove it. Excess handling can cause additional damage.

1. Remove the print cartridge. See [Remove the print cartridge on page 99](#).
2. Use needle-nose pliers to release the transfer roller tabs at the end of the roller, near the right side of the product.

 **CAUTION:** Do not break the tabs and do not touch the roller.

**Figure 5-89** Remove the transfer roller

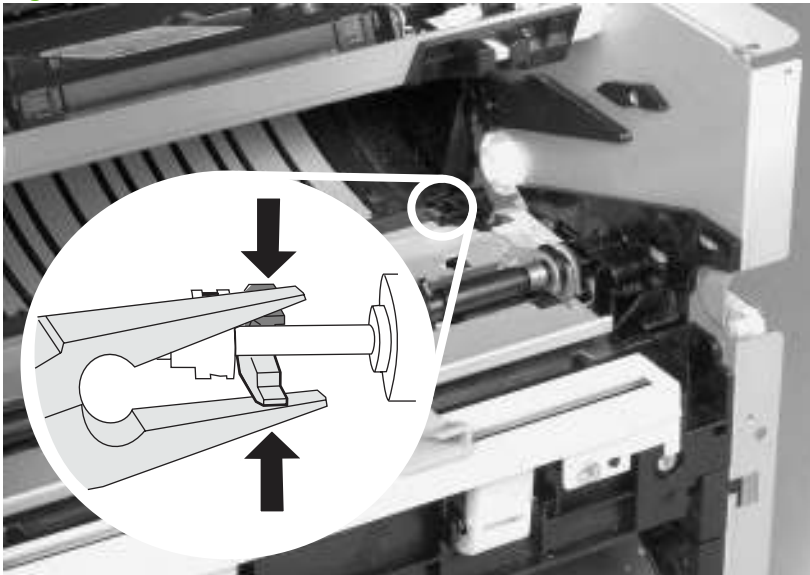

3. Lift up the end of the roller near the right side of the product, and then slide it toward the right side of the product while pulling it out of the product.

## Registration-roller assembly

1. Remove five screws (callout 1).

**Figure 5-90** Remove the registration-roller assembly

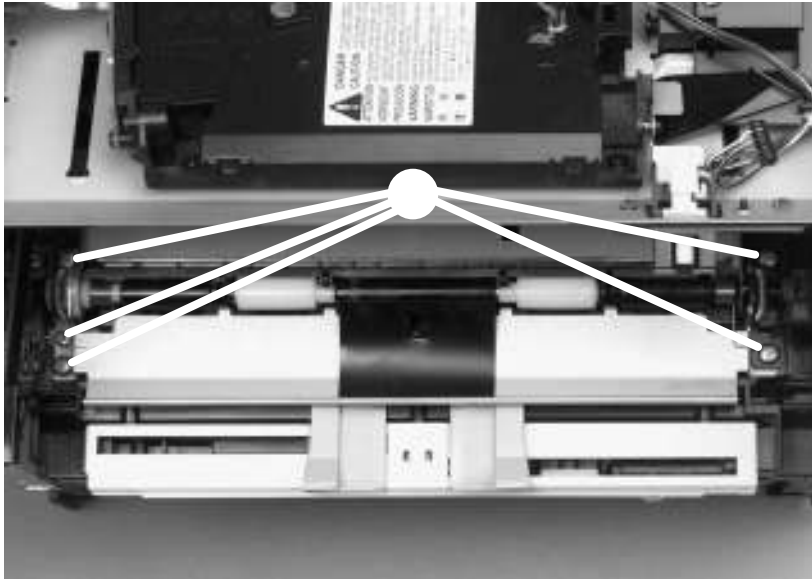

2. Lift the entire assembly out of the product.

## Main gear assembly and tray 2 pickup solenoid

1. Remove the following components.
  - Right cover. See [Right cover on page 100](#).
  - Left cover. See [Left cover on page 102](#).
  - Rear cover. See [Rear cover on page 106](#).
  - Top cover. See [Top cover on page 108](#).
  - Convenience-stapler power supply (HP LaserJet M2727nfs only). See [Convenience-stapler power supply \(HP LaserJet M2727nfs only\) on page 124](#).
  - Convenience-stapler power supply bracket and strap (HP LaserJet M2727nfs only). See [Convenience-stapler power supply bracket and strap \(HP LaserJet M2727nfs only\) on page 127](#).
  - Power switch PCA. See [Power-switch PCA on page 130](#).
  - Fan. See [Fan on page 141](#).
2. Disconnect one connector (callout 1; J206) at the ECU and pull the wires through the chassis.

**Figure 5-91** Remove the main gear assembly (1 of 5)



3. Squeeze the retainer tabs on the gear-release lever to disconnect the lever from the print-cartridge door arm.

**Figure 5-92** Remove the main gear assembly (2 of 5)

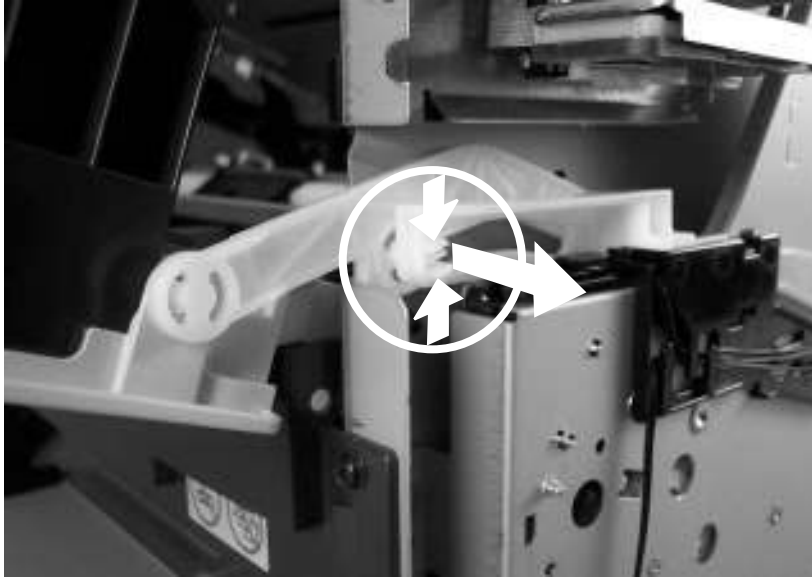

4. Release the tab on the gear (callout 2) and slide the gear off of the shaft.
5. Remove the wire harnesses from the guide (callout 3).
6. Remove four screws (callout 4).

**Figure 5-93** Remove the main gear assembly (3 of 5)

7. Pull the main gear assembly straight away from the product.

---

 **NOTE:** The large gear at the top of the assembly is not captive. Make sure that the gear does not separate from the assembly when the assembly is removed.

---

**Figure 5-94** Remove the main gear assembly (4 of 5)

8. Remove one screw (callout 5), and then lift the solenoid off of the product.

**Figure 5-95** Remove the tray 2 pickup solenoid (5 of 5)

---

# 6 Solve problems

- [Problem-solving checklist](#)
- [Control-panel messages](#)
- [Clear jams](#)
- [Control-panel menus](#)
- [Print problems](#)
- [Scan problems](#)
- [Copy problems](#)
- [Fax problems](#)
- [Control-panel display problems](#)
- [Convenience-stapler problems \(HP LaserJet M2727nfs only\)](#)
- [DSL problems](#)
- [ADF problems](#)
- [Functional checks](#)
- [Service-mode functions](#)
- [Problem-solve tools](#)
- [Firmware updates](#)

# Problem-solving checklist

Follow these steps when trying to solve a problem with the product.

| Step number | Verification step   | Possible problems  | Solutions  |
|-------------|---|--|--|
| 1           | <p><b>Is the power on?</b></p> <p>When the product is connected to a grounded power source and is turned on, the control panel shows <b>Hewlett Packard</b> with moving cursors indicating that the firmware code is loading, and the main motor rotates for approximately 45 to 60 seconds. When the firmware is done loading, <b>Scanner bulb warming up</b> might appear on the control-panel display, and the scan head moves back and forth for 10 to 15 seconds. If you lift the scanner cover, you will see that the scanner bulb is lit. Near the end of this time, the automatic document feeder (ADF) motor turns on for about two seconds.</p> | No power as a result of a failed power source, cable, switch, or fuse.                               | <ol style="list-style-type: none"> <li>1. Verify that the product is plugged in.</li> <li>2. Verify that the power cable is functional and that the power switch is on.</li> <li>3. Check the power source by plugging the product directly into the wall or into a different outlet.</li> </ol>   |
|             |   | Motor does not start.  | <ol style="list-style-type: none"> <li>1. Verify that the product is plugged into a working electrical receptacle.</li> <li>2. Verify that the print cartridge is installed correctly. Follow the instructions on the control panel to remove and replace the cartridge.</li> <li>3. Verify that the top cover is closed.</li> </ol>   |
|             |   | ADF motor does not start.  | <p>Open the ADF cover and remove any orange shipping tape inside the ADF.</p> <p>Verify that the ADF connector is connected correctly to the scanner.</p> <p>If the ADF motor still does not rotate, replace the ADF. See <a href="#">ADF assembly on page 115</a>.</p>  |
|             |   | Scanner bulb does not light.   | <p>If the scanner bulb does not light, verify that the wire-harness connectors from the scanner to the formatter are connected correctly.</p> <p>If the error persists, replace the following components one at a time until the problem is resolved: scanner assembly, formatter. See <a href="#">Scanner/ADF assembly on page 117</a> and <a href="#">Formatter on page 132</a>.</p> |
| 2           | <p><b>Does Ready appear in the product control panel?</b></p> <p>The control panel should function without error messages.</p>  | <p>Control panel shows an error.</p> <p>Asian control panel characters do not display correctly.</p> | <p>See <a href="#">Control-panel messages on page 169</a> for a list of common messages that will help you correct the error.</p> <p>If the product uses the Asian control panel and the formatter was recently replaced, make sure that the Asian character display PCA is installed correctly and fully seated in the formatter connector (H3).</p>                                  |

| Step number | Verification step  | Possible problems   | Solutions   |
|-------------|--|---|---|
| 3           | <b>Do information pages print?</b><br><br>Print a Configuration page.  | Error message appears on the control-panel display.   | See <a href="#">Control-panel messages on page 169</a> for a list of common messages that will help you correct the error.  |
|             |  | Media does not move smoothly through the product paper path.  | Make sure the media meets HP specifications. See <a href="#">Media specifications on page 16</a> .<br><br>Clean the paper path. See <a href="#">Clean the paper path on page 56</a> .   |
|             |  | Poor print quality.   | See <a href="#">Print-quality problems on page 204</a> .  |
| 4           | <b>Does the product copy?</b><br><br>Place the Configuration page into the ADF and make a copy. The report should feed smoothly through the ADF, and copies should print without print-quality problems. Make a copy from the flatbed as well. | Poor copy quality from the ADF.   | <ol style="list-style-type: none"> <li>1. If the print quality from the internal tests and the copy from the flatbed are acceptable, clean the ADF scanning glass. See <a href="#">Clean the product on page 49</a>.</li> <li>2. If the ADF is damaged, replace the ADF. See <a href="#">ADF assembly on page 115</a>.</li> </ol>   |
|             |  | Media does not move smoothly through the ADF path.  | <ol style="list-style-type: none"> <li>1. Make sure that the media in the ADF meets ADF specifications.</li> <li>2. Clean the ADF pick roller. See <a href="#">Clean the product on page 49</a>.</li> <li>3. If the problem persists, replace the ADF pick roller. See <a href="#">Replace the ADF pickup-roller assembly on page 110</a>.</li> <li>4. If the problem persists, replace the ADF. See <a href="#">ADF assembly on page 115</a>.</li> </ol> |
|             |  | Poor copy quality from the flatbed.   | If the print quality from the internal tests and the copy from the ADF are acceptable, clean the flatbed glass. See <a href="#">Clean the product on page 49</a> .  |
| 5           | <b>Does the product send a fax?</b><br><br>Connect the telephone line and press <b>Start Fax</b> to verify that a dial tone exists (using a hand set, if necessary). Attempt to send a fax.  | Telephone line is not operational or the product is not plugged into the telephone line                 | Verify that the product is plugged into a telephone line that you know works.   |
|             |  | Telephone cord is faulty or is plugged into the wrong connector.  | <ol style="list-style-type: none"> <li>1. Try plugging the telephone cord into the other connector.</li> <li>2. Try a new telephone cord.</li> </ol>  |
|             |  | Fax number is incorrect or incomplete.  | Check the fax number and retype the correct and complete fax number.  |
|             |  | Product fax settings are set incorrectly.   | Review and reset the product fax settings.  |
| 6           | <b>Does the product receive a fax?</b><br><br>Use another fax machine to send a fax to the product.  | Too many telephone devices are plugged in, or telephone devices are not connected in the correct order. | Make sure that the product is the only device on the telephone line and try again to receive the fax.   |
|             |  | Product fax settings are set incorrectly.   | Review and reset the product fax settings.  |
|             |  |   | <b>NOTE:</b> If the product is connected to a computer, use the HP Fax Setup Wizard to review and reset fax settings.   |

| Step number                               | Verification step  | Possible problems  | Solutions  |
|---|--|--|--|
| 7   | <p><b>Does the product print from the computer?</b></p> <p>Connect the network cable or USB cable to the product and the computer. Use a word-processing program to send a print job to the product.</p> | Software is not installed correctly or an error occurred during software installation. | Uninstall and then reinstall the product software. Verify that you are using the correct installation procedure and the correct port setting.  |
|   |  | The cable is not connected correctly.  | Reconnect the cable.   |
|   |  | Incorrect driver is selected.  | Select the correct driver.   |
|   |  | Other devices are connected to the USB port.   | Disconnect the other devices and try to print again.   |
|   |  | There might be a problem with the network connection.                                  | <p>If printing through the network, verify that the device has a valid TCP/IP address by checking the network configuration. If the issue persists, verify that the green LED on the network connector on the back of the device is lit. If it is not lit, there might be a bad network connection, cable, or network device (router or hub).</p> <p>If the issue persists after verifying the above, uninstall and then reinstall the network driver software from the device installation CD. Print a Configuration page for reference to the TCP/IP address during reinstallation.</p> <p>If the problem still persists, replace the formatter.</p> |
| Port driver problem in Microsoft Windows. | Uninstall and then reinstall the product software. Verify that you are using the correct installation procedure and the correct port setting.  |  |  |
| 8   | <p><b>Does the product scan to the computer?</b></p> <p>Turn the product off, and then on. Initiate a scan from the basic desktop software at your computer.</p>   | Cable is not connected correctly.  | Reconnect the cable.   |
|   |  | Software is not installed correctly or an error occurred during software installation. | Uninstall and then reinstall the product software. Verify that you are using the correct installation procedure and the correct port setting.  |

# Control-panel messages

The majority of the control-panel messages are intended to guide the user through typical operation. The control-panel messages indicate the status of the current operation, and include a page count on the second line of the display, if appropriate. When the product is receiving fax data, print data, or scanning commands, control-panel messages indicate this status. In addition, alert messages, warning messages, and critical error messages indicate situations that might require some action.

## Alert and warning messages

Alert and warning messages appear temporarily and might require the user to acknowledge the message by pressing **OK** to resume or by pressing **Cancel** to cancel the job. With certain warnings, the job might not complete or the print quality might be affected. If the alert or warning message is related to printing and the auto-continue feature is on, the product will attempt to resume the printing job after the warning has appeared for 10 seconds without acknowledgement.

## Alert and warning message tables

**Table 6-1** Alert and warning messages

| Control panel message                | Description   | Recommended action   |
|--------------------------------------|---|--|
| <b>10.0000 Supply Memory Error</b>   | A specific print cartridge has an e-label error.  | Reinstall the print cartridge.<br><br>Turn off and then turn on the product.<br><br>If the problem is not solved, replace the cartridge.   |
| <b>10.1000 Supply Memory Error</b>   | A specific print cartridge has a missing e-label.   | Reinstall the print cartridge.<br><br>Turn off and then turn on the product.<br><br>If the problem is not solved, replace the cartridge.   |
| <b>ADF door is open</b>              | The ADF lid is open or a sensor is malfunctioning.  | Make sure that the ADF lid is closed.<br><br>Remove the ADF and reinstall it.<br><br>If the message persists, turn off the power by using the power switch, wait at least 30 seconds, and then turn on the power and wait for the product to initialize.<br><br>If the error persists, contact HP. See <a href="http://www.hp.com/support/LJM2727">www.hp.com/support/LJM2727</a> or the support flyer that came in the product box. |
| <b>Canceled copy. Clear document</b> | The <b>Cancel</b> button was pressed to cancel the current job while pages were feeding from the ADF. The cancel process does not automatically clear the ADF.      | Remove the jammed item. See <a href="#">Clear jams from the ADF on page 180</a> . Then, clear the items in the ADF tray and start over.  |
| <b>Canceled scan. Clear document</b> | The <b>Cancel</b> button was pressed to cancel the current job while pages were feeding from the ADF. The cancel process does not automatically clear the ADF.      | Remove the jammed item. See <a href="#">Clear jams from the ADF on page 180</a> . Then, clear the items in the ADF tray and start over.  |
| <b>Canceled send. Clear document</b> | The <b>Cancel</b> button was pressed to cancel the current job while pages were feeding from the ADF tray. The cancel process does not automatically clear the ADF. | Remove the jammed item. See <a href="#">Clear jams from the ADF on page 180</a> . Then, clear the items in the ADF tray and start over.  |

**Table 6-1 Alert and warning messages (continued)**

| Control panel message                  | Description  | Recommended action   |
|--|--|--|
| <b>Comm. error [Receiver CSID]</b>     | A fax communication error occurred between the product and the receiver.                                     | <p>Allow the product to retry sending the fax. Unplug the product telephone cord from the wall, plug in a telephone, and try making a call. Plug the product phone cord into a jack for another phone line.</p> <p>Try a different phone cord.</p> <p>If the error persists, contact HP. See <a href="http://www.hp.com/support/LJM2727">www.hp.com/support/LJM2727</a> or the support flyer that came in the product box.</p> |
| <b>Comm. error [Sender CSID]</b>       | A fax communication error occurred between the product and the sender.                                       | <p>Allow the product to retry sending the fax. Unplug the product telephone cord from the wall, plug in a telephone, and try making a call. Plug the product phone cord into a jack for another phone line.</p> <p>Try a different phone cord.</p> <p>If the error persists, contact HP. See <a href="http://www.hp.com/support/LJM2727">www.hp.com/support/LJM2727</a> or the support flyer that came in the product box.</p> |
| <b>Device error, press OK</b>          | Generic engine error.  | This is a warning message only. Job output might be affected.  |
| <b>Device is busy. Try again later</b> | The product is currently in use.   | Wait for the product to finish the current job.  |
| <b>Doc feeder jam Clear, Reload</b>    | A piece of media is jammed in the ADF tray.  | <p>Open the document release door, clear the jam, close the document release door, and reload the paper into the ADF tray.</p> <p>If the error persists, contact HP. See <a href="http://www.hp.com/support/LJM2727">www.hp.com/support/LJM2727</a> or the support flyer that came in the product box.</p>   |
| <b>Doc feeder jam, DATE/TIME</b>       | ADF has not been cleared since previous jam.   | Clear the jam.   |
| <b>Document feeder mispick. Reload</b> | Media in the ADF tray was not picked up.   | <p>Remove the media from the ADF tray, and then reload it.</p> <p>Clean the ADF pickup roller. See <a href="#">Clean the ADF pickup-roller assembly on page 55</a>.</p> <p>If the error persists, contact HP. See <a href="http://www.hp.com/support/LJM2727">www.hp.com/support/LJM2727</a> or the support flyer that came in the product box.</p>  |
| <b>Door open</b>                       | The print-cartridge door is open.  | Close the print-cartridge door.  |
| <b>Engine comm. error</b>              | The product experienced a print engine communication error.  | This is a warning message only. Job output might be affected.  |
| <b>Engine error, press OK</b>          | The product experienced a print engine error.  | This is a warning message only. Job output might be affected.  |
| <b>Fit to Page on flatbed only</b>     | The copy reduce/enlarge feature (called "Fit to Page") applies only to copies made from the flatbed scanner. | Use the flatbed or select another reduction/enlargement setting.   |
| <b>Install black cartridge</b>         | No cartridge installed with door closed.   | Install print cartridge.   |



**Table 6-1 Alert and warning messages (continued)**

| Control panel message   | Description  | Recommended action   |
|---|--|--|
| <b>Invalid driver Press OK</b>  | You are using the incorrect printer driver.  | Select the printer driver that is appropriate for your product.  |
| <b>Invalid entry</b>  | Invalid data or response.  | Correct the entry.   |
| <b>Jam in (area), Open door and clear jam</b>                                 | Paper jam in one of the following areas: drum area, fuser area, duplex feeding area, duplex receiving area, and duplex pickup area.                | Clear the jam from the area indicated on the product control panel, and then follow the control panel instructions. See <a href="#">Clear jams on page 179</a> .   |
| <b>Jam in Tray #, Clear jam and then press OK</b>                             | The product has detected a jam in an input tray.   | Clear the jam from the area indicated on the product control panel, and then follow the control panel instructions. See <a href="#">Clear jams on page 179</a> .   |
| <b>Load paper</b>   | Out of paper in all available trays.   | Load paper in trays.   |
| <b>Load Tray # &lt;TYPE&gt; &lt;SIZE&gt;, Press OK to use available media</b> | Device is processing job, but a matching tray is empty.  | Press <b>OK</b> to use existing available media.   |
| <b>Load tray #, Press OK</b>  | Manual duplex mode. “#” is the tray number where the first half of the job printed.  | Load paper in the correct tray.  |
| <b>Load Tray 1 &lt;TYPE&gt; &lt;SIZE&gt;, Press OK to use available media</b> | Device is processing job, but no trays match.  | Press <b>OK</b> to use existing tray settings.   |
| <b>Load Tray 1, &lt;PLAIN&gt; &lt;SIZE&gt; / Cleaning mode, OK to start</b>   | Cleaning mode paper prompt.  | Press <b>OK</b> to begin the cleaning procedures.  |
| <b>Manual feed &lt;SIZE&gt; &lt;TYPE&gt;, Press OK to use available media</b> | Print Manual Feed mode.  | Load paper into the priority input tray.   |
| <b>Mem. low 1 copy. Press OK</b>  | The product completed making one copy. The remaining copies have been canceled because of low memory.  | Press <b>Cancel</b> to clear the error. Break the job into smaller jobs that contain fewer pages.  |
| <b>Memory is low Try again later</b>  | The product does not have enough memory to start a new job.  | Wait until the current job is finished before starting a new job.  |
| <b>Memory is low. Press OK</b>  | The product memory has been almost completely filled.  | Allow the product to finish the job, or press <b>Setup</b> to cancel the job.  |
| <b>Memory low Only 1 copy made</b>  | The product does not have enough memory to complete the collated copy job.   | Break the job into smaller jobs that contain fewer pages.  |
| <b>Misprint, Press OK</b>   | Feed delay misprint.   | Reload paper.  |
| <b>No paper pickup, Press OK</b>  | The product has failed to pick up a piece of media.  | Verify that the media was inserted far enough into the input tray. In tray 1, verify that the paper-length guide is in the correct position for the media size that you are using.<br><br>Reload the media in the input tray and press <b>Setup</b> to continue the job.<br><br>If the error persists, contact HP. See <a href="http://www.hp.com/support/LJM2727">www.hp.com/support/LJM2727</a> or the support flyer that came in the product box. |
| <b>Non-HP supply installed</b>  | A new supply has been installed that is not made by HP. This message appears for several seconds, and then the product returns to the Ready state. | If you believe you purchased an HP supply, please call the HP fraud hotline at 1-877-219-3183. Service or repairs that are required as a result of using non-HP supplies is not covered under HP warranty.   |

**Table 6-1 Alert and warning messages (continued)**

| Control panel message   | Description   | Recommended action   |
|---|---|--|
| <b>Order black Cartridge</b>  | Print cartridge is low.   | Order a new print cartridge.   |
| <b>Page too complex, press OK</b>   | The product could not print the current page because of its complexity. | Press <b>Setup</b> to clear the message.<br>Allow the product to finish the job, or press <b>Cancel</b> to cancel the job. |
| <b>Scanner reserved for PC scan</b>   | A computer is using the product to create a scan.                       | Wait until the computer scan has finished, or cancel the scan from the computer software, or press <b>Cancel</b> .         |
| <b>Scanning error Cannot connect</b>  | The product cannot transmit scan information to a computer.             | Verify that the connection cable is not loose or damaged. Replace the cable if necessary, and try the scan again.          |
| <b>Settings cleared, DATE/TIME</b>  | The product has cleared job settings.                                   | Re-enter any appropriate job settings.   |
| <b>Used black cartridge in use</b><br>alternates with<br><b>to accept, press OK</b> | A used printer cartridge has been installed or moved.                   | Press <b>OK</b> to return to the Ready state.  |

**Table 6-2 Alert and warning messages**

| Control panel message                 | Description  | Recommended action  |
|---------------------------------------|--|---|
| <b>Comm. error</b>                    | A fax communication error occurred between the product and the sender or receiver.               | Allow the product to retry sending the fax. Unplug the product telephone cord from the wall, plug in a telephone, and try making a call. Plug the product phone cord into a jack for another phone line.<br><br>Try a different phone cord.<br><br>If the error persists, contact HP. See <a href="http://www.hp.com/support/LJM2727">www.hp.com/support/LJM2727</a> or the support flyer that came in the product box. |
| <b>Fax delayed – Send memory full</b> | Fax memory is full.  | Cancel the fax by pressing <b>OK</b> or <b>Cancel</b> . Resend the fax. You might need to send the fax in multiple sections if the error occurs again.  |
| <b>Fax is busy Canceled send</b>      | The fax line to which you were sending a fax was busy. The product has canceled sending the fax. | Call the recipient to ensure that the fax machine is on and ready.<br><br>Check that you are dialing the correct fax number.<br><br>Check that the <b>Redial if busy</b> option is enabled.<br><br>Check for a dial tone on the phone line by pressing <b>Start Fax</b> .<br><br>Make sure that the phone is working by disconnecting the product, plugging in a telephone to the phone line, and making a voice call.  |

**Table 6-2 Alert and warning messages (continued)**

| Control panel message                  | Description  | Recommended action  |
|--|--|---|
|  |  | <p>Plug the product phone cord into a jack for another phone line, and then try sending the fax again.</p> <p>Try a different phone cord.</p> <p>If the error persists, contact HP. See <a href="http://www.hp.com/support/LJM2727">www.hp.com/support/LJM2727</a> or the support flyer that came in the product box.</p>   |
| <b>Fax is busy Redial pending</b>      | The fax line to which you were sending a fax was busy. The product automatically redials the busy number.  | <p>Allow the product to retry sending the fax.</p> <p>Call the recipient to ensure that the fax machine is on and ready.</p> <p>Check that you are dialing the correct fax number.</p> <p>Check for a dial tone on the phone line by pressing <b>Start Fax</b>.</p> <p>Make sure that the phone is working by disconnecting the product, plugging in a telephone to the phone line, and making a voice call.</p> <p>Plug the product phone cord into a jack for another phone line, and try sending the fax again.</p> <p>Try a different phone cord.</p> <p>If the error persists, contact HP. See <a href="http://www.hp.com/support/LJM2727">www.hp.com/support/LJM2727</a> or the support flyer that came in the product box.</p> |
| <b>Fax memory full Canceling recv.</b> | During the fax transmission, the product ran out of memory. Only the pages that fit into memory will be printed.   | <p>Print all of the faxes, and then have the sender resend the fax. Have the sender divide the fax job into multiple jobs before resending. Cancel all fax jobs or clear the faxes from memory.</p> <p>Note: Adding a memory DIMM does not help resolve this issue.</p>   |
| <b>Fax memory full Canceling send</b>  | During the fax job, the memory filled. All pages of the fax have to be in memory for a fax job to work correctly. Only the pages that fit into memory were sent. | <p>Print all received faxes or wait until all pending faxes are sent.</p> <p>Ask the sender to send the fax again.</p> <p>Cancel all fax jobs or clear the faxes from memory.</p>   |
| <b>Fax recv. error</b>                 | An error occurred while trying to receive a fax.   | <p>Ask the sender to resend the fax.</p> <p>Try faxing back to the sender or another fax machine.</p> <p>Check for a dial tone on the phone line by pressing <b>Start Fax</b>.</p> <p>Check that the telephone cord is securely connected by unplugging and replugging the cord.</p>  |

**Table 6-2 Alert and warning messages (continued)**

| Control panel message                  | Description   | Recommended action  |
|--|---|---|
|  |   | <p>Make sure that you are using the telephone cord that came with the product.</p> <p>Make sure that the phone is working by disconnecting the product, plugging in a telephone to the phone line, and making a voice call.</p> <p>Decrease the fax speed. Ask the sender to resend the fax.</p> <p>Turn off error-correction mode. Ask the sender to resend the fax.</p> <p>Connect the product to a different phone line.</p> <p>If the error persists, contact HP. See <a href="http://www.hp.com/support/LJM2727">www.hp.com/support/LJM2727</a> or the support flyer that came in the product box.</p>   |
| <b>Fax Send error</b>                  | An error occurred while trying to send a fax.   | <p>Try resending the fax.</p> <p>Try faxing to another fax number.</p> <p>Check for a dial tone on the phone line by pressing <b>Start Fax</b>.</p> <p>Check that the telephone cord is securely connected by unplugging and replugging the cord.</p> <p>Make sure that you are using the telephone cord that came with the product.</p> <p>Make sure that the phone is working by disconnecting the product, plugging in a telephone to the phone line, and making a voice call.</p> <p>Connect the product to a different phone line.</p> <p>Set the fax resolution to <b>Standard</b> instead of the default of <b>Fine</b>.</p> <p>If the error persists, contact HP. See <a href="http://www.hp.com/support/LJM2727">www.hp.com/support/LJM2727</a> or the support flyer that came in the product box.</p> |
| <b>Group dial not allowed in group</b> | The speed-dial code that you typed is programmed for a group. Adding a group-dial to another group-dial is not allowed. | Add one-touch buttons (programmed as an individual speed dial) or speed-dial codes to a group-dial.   |
| <b>Invalid entry</b>                   | Invalid data or response.   | Correct the entry.  |
| <b>No Dial Tone</b>                    | The product could not detect a dial tone.   | <p>Check for a dial tone on the phone line by pressing <b>Start Fax</b>.</p> <p>Unplug the telephone cord from both the product and the wall and replug the cord.</p> <p>Make sure that you are using the telephone cord that came with the product.</p>  |

**Table 6-2 Alert and warning messages (continued)**

| Control panel message               | Description  | Recommended action  |
|-------------------------------------|--|---|
|                                     |  | <p>Unplug the product telephone cord from the wall, plug in a telephone, and try making a voice call.</p> <p>Plug the product phone cord into a jack for another phone line.</p> <p>If the error persists, contact HP. See <a href="http://www.hp.com/support/LJM2727">www.hp.com/support/LJM2727</a> or the support flyer that came in the product box.</p>  |
| <b>No document sent</b>             | The product did not scan any pages, or it did not receive any pages from the computer to transmit a fax. | Try sending the fax again.  |
| <b>No fax answer Redial pending</b> | The receiving fax line did not answer. The product attempts to redial after a few minutes.               | <p>Allow the product to retry sending the fax.</p> <p>Call the recipient to ensure that the fax machine is on and ready.</p> <p>Check that you are dialing the correct fax number.</p> <p>If the product continues to redial, unplug the product telephone cord from the wall, plug in a telephone, and try making a voice call.</p> <p>Plug the product phone cord into a jack for another phone line.</p> <p>Try a different phone cord.</p> <p>If the error persists, contact HP. See <a href="http://www.hp.com/support/LJM2727">www.hp.com/support/LJM2727</a> or the support flyer that came in the product box.</p>                  |
| <b>No fax answer. Canceled send</b> | Attempts to redial a fax number failed, or the "Redial-no answer" option was turned off.                 | <p>Call the recipient to ensure that the fax machine is on and ready.</p> <p>Check that you are dialing the correct fax number.</p> <p>Check that the redial option is enabled.</p> <p>Unplug the telephone cord from both the product and the wall and replugin the cord.</p> <p>Unplug the product telephone cord from the wall, plug in a telephone, and try making a voice call.</p> <p>Plug the product phone cord into a jack for another phone line.</p> <p>If the error persists, contact HP. See <a href="http://www.hp.com/support/LJM2727">www.hp.com/support/LJM2727</a> or the support flyer that came in the product box.</p> |
| <b>No fax detected</b>              | The product answered the incoming call but did not detect that a fax machine was calling.                | <p>Allow the product to retry receiving the fax.</p> <p>Try a different phone cord.</p> <p>Plug the product phone cord into a jack for another phone line.</p>  |

**Table 6-2 Alert and warning messages (continued)**

| Control panel message | Description | Recommended action   |
|-----------------------|-------------|--|
|                       |             | If the error persists, contact HP. See <a href="http://www.hp.com/support/LJM2727">www.hp.com/support/LJM2727</a> or the support flyer that came in the product box. |

## Critical error messages

Critical error messages can indicate some kind of failure. Turning off and then turning on the power might fix the problem. If a critical error persists, the product might require service.

### Critical error message-tables

**Table 6-3 Critical error messages**

| Control panel message               | Description  | Recommended action   |
|-------------------------------------|--|--|
| <b>49 Error, Turn off then on</b>   | The product has experienced an internal embedded software error.   | <p>Turn off the power by using the power switch, wait at least 30 seconds, and then turn on the power and wait for the product to initialize.</p> <p>If the error persists, contact HP. See <a href="http://www.hp.com/support/LJM2727">www.hp.com/support/LJM2727</a> or the support flyer that came in the product box.</p>  |
| <b>50.x Fuser Error</b>             | The product has experienced an internal hardware error.            | <ol style="list-style-type: none"><li>1. Turn off the power by using the power switch, and then wait at least 30 seconds.</li><li>2. If a surge protector is being used, remove it. Plug the product directly into the wall socket.</li><li>3. Turn on the power and wait for the product to initialize.</li></ol> <p>If the error persists, contact HP. See <a href="http://www.hp.com/support/LJM2727">www.hp.com/support/LJM2727</a> or the support flyer that came in the product box.</p> |
| <b>52 Scanner Error</b>             | The product has experienced an internal hardware error.            | <p>Turn off the power by using the power switch, wait at least 30 seconds, and then turn on the power and wait for the product to initialize.</p> <p>If a surge protector is being used, remove it. Plug the product directly into the wall socket. Use the power switch to turn the product on.</p> <p>If the error persists, contact HP. See <a href="http://www.hp.com/support/LJM2727">www.hp.com/support/LJM2727</a> or the support flyer that came in the product box.</p>               |
| <b>55.4 Error, Turn off then on</b> | The product has experienced an engine communication timeout error. | <p>Turn off the power by using the power switch, wait at least 30 seconds, and then turn on the power and wait for the product to initialize.</p> <p>If a surge protector is being used, remove it. Plug the product directly into the wall socket. Use the power switch to turn the product on.</p> <p>If the error persists, contact HP. See <a href="http://www.hp.com/support/LJM2727">www.hp.com/support/LJM2727</a> or the support flyer that came in the product box.</p>               |
| <b>79 Error Turn off then on</b>    | The product has experienced an internal firmware error.            | <p>Turn off the power by using the power switch, wait at least 30 seconds, and then turn on the power and wait for the product to initialize.</p> <p>If you have recently installed a memory DIMM in the product, turn off the product, remove the memory DIMM, reinstall the DIMM to</p>  |

**Table 6-3 Critical error messages (continued)**

| Control panel message                    | Description  | Recommended action   |
|--|--|--|
|  |  | <p>verify that it is seated properly, and then turn on the product.</p> <p>If a surge protector is being used, remove it. Plug the product directly into the wall socket. Use the power switch to turn the product on.</p> <p>If the error persists, contact HP. See <a href="http://www.hp.com/support/LJM2727">www.hp.com/support/LJM2727</a> or the support flyer that came in the product box.</p>   |
| <b>Scanner error #, Turn off then on</b> | The product has experienced an error in the scanner sub-assembly area. | <p>Turn off the power by using the power switch, wait at least 30 seconds, and then turn on the power and wait for the product to initialize.</p> <p>If a surge protector is being used, remove it. Plug the product directly into the wall socket. Use the power switch to turn the product on.</p> <p>If the error persists, contact HP. See <a href="http://www.hp.com/support/LJM2727">www.hp.com/support/LJM2727</a> or the support flyer that came in the product box.</p> |



# Clear jams

## Causes of jams

Occasionally, paper or other print media can become jammed during a print job. Some causes include:

- The input trays are loaded improperly or overfilled, or the media guides are not set properly.
- Media is added to or removed from an input tray during a print job or an input tray is removed from the product during a print job.
- The cartridge door is opened during a print job.
- Too many sheets have accumulated in an output area, or sheets are blocking an output area.
- The print media that is being used does not meet HP specifications. See [Media specifications on page 16](#).
- The media is damaged or has foreign objects attached to it, such as staples or paper clips.
- The media has already passed through the product print path and is being reused.
- The environment in which the print media was stored is too humid or too dry. See [Media specifications on page 16](#).

## Where to look for jams

Jams can occur in these locations:

- In the automatic document feeder (ADF)
- In input areas
- In the automatic duplexer
- In output areas
- Inside the product

Find and remove the jam by using the instructions on the following pages. If the location of the jam is not obvious, first look inside the product.

Loose toner might remain in the product after a jam. This problem typically resolves itself after a few sheets have been printed.

## Clear jams from the ADF

Occasionally, media becomes jammed during a fax, copy, or scan job.

You are notified of a media jam by the **Doc feeder jam Clear, Reload** message that appears on the product control-panel display.

- The ADF input tray is loaded incorrectly or is too full. See [Load paper and print media on page 26](#) for more information.
  - The media does not meet HP specifications, such as those for size or type. See [Media specifications on page 16](#) for more information.
1. Open the ADF cover.

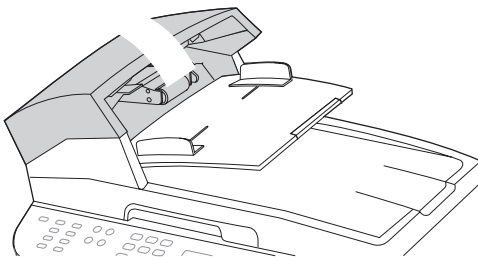

---

 **NOTE:** Verify that any shipping tape inside the ADF has been removed.

---

2. Remove the jam cleanout part. Using both hands, lift up on the two handles until the part unsnaps. Rotate and lift out the cleanout part and set it aside.

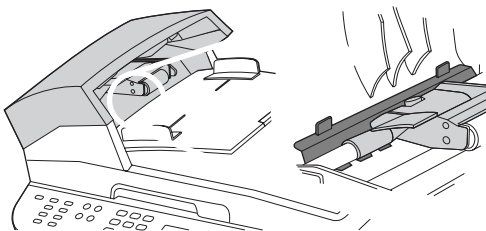

3. Lifting the green lever, and then rotate the pick mechanism until it stays open.

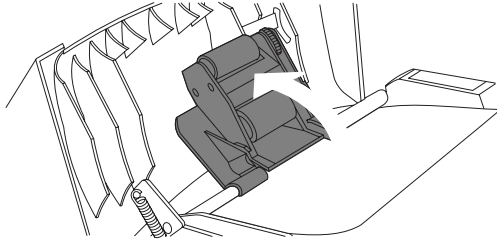

4. Gently try to remove the page without tearing it. If you feel resistance, go to the next step.

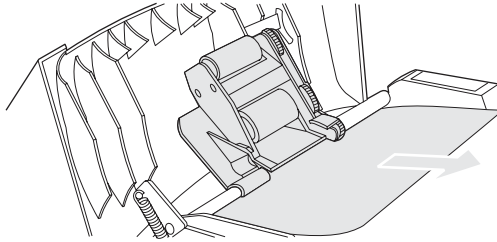

5. Open the ADF lid and gently loosen the media using both hands.

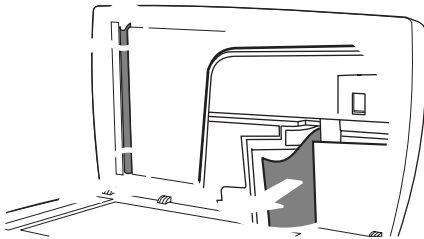

6. When the media is free, gently pull it out in the direction shown.

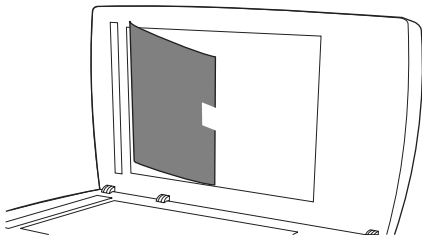

7. Close the lid to the flatbed scanner.

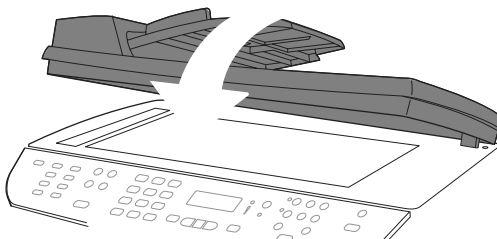

8. Lower the green lever.

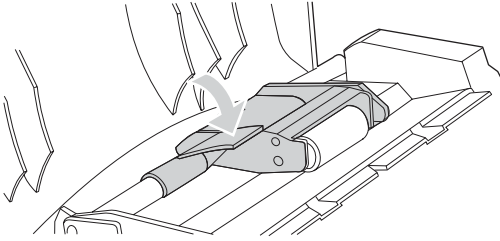

9. Reinstall the cleanout part by inserting it as shown. Push down on the two tabs until the part snaps into place. Install the cleanout part correctly, because future jamming might occur if the cleanout part is not replaced correctly.

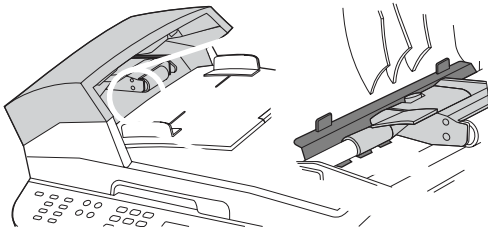

10. Close the ADF lid.

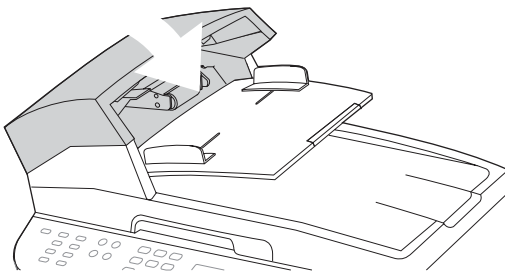

## Clear jams from the input-tray areas

**CAUTION:** Do not use sharp objects, such as tweezers or needle-nose pliers, to remove jams. Damages caused by sharp objects are not covered by the warranty.

When removing jammed media, pull the jammed media straight away from the product. Pulling jammed media out of the product at an angle can damage the product.

 **NOTE:** Depending on where the jam is located, some of the following steps might not be necessary.

1. Open the rear output door.

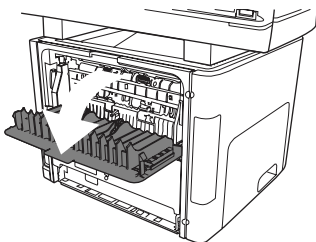

2. Rotate the green pressure-release levers downward.

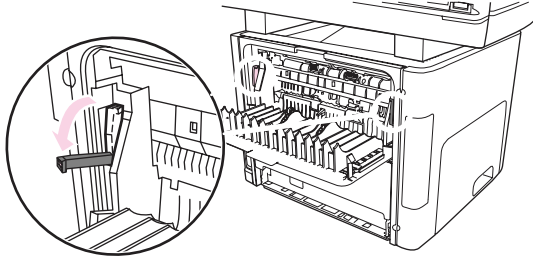

3. Open tray 2 and optional tray 3.

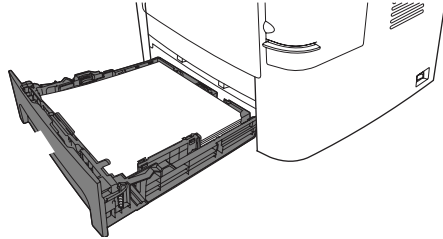

4. With both hands, grasp the side of the media that is most visible (this includes the middle), and carefully pull it free from the product.

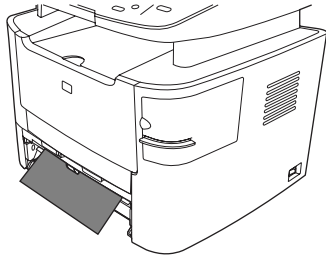

5. If no media is visible, open the print-cartridge door, remove the print cartridge, and then rotate the upper media guide. Carefully pull the media up and out of the product. Replace the print cartridge.

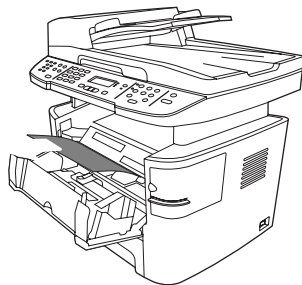

6. Close tray 2 and optional tray 3.
7. Close the rear output door.

## Clear jams from the duplexer

**CAUTION:** Do not use sharp objects, such as tweezers or needle-nose pliers, to remove jams. Damages caused by sharp objects are not covered by the warranty.

When removing jammed media, pull the jammed media straight away from the product. Pulling jammed media out of the product at an angle can damage the product.

 **NOTE:** Depending on where the jam is located, some of the following steps might not be necessary.

1. Open the rear output door.

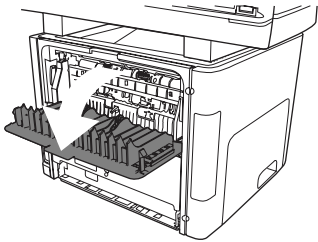

2. Rotate the green pressure-release levers downward.

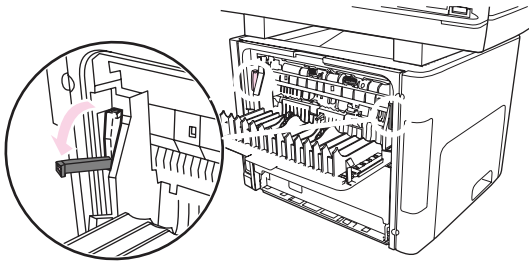

3. Remove tray 2.

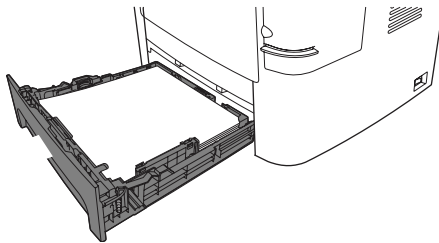

4. Push down on the green lever on the automatic two-sided path door on the front of the product.

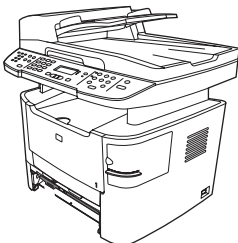

5. With both hands, grasp the side of the media that is most visible (this includes the middle), and carefully pull it free from the product.

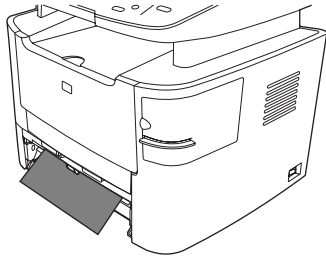

 **NOTE:** If you cannot grasp the media with your hands, perform the procedure in [Clear jams from the print-cartridge area on page 188](#).

6. Close the automatic two-sided path door.

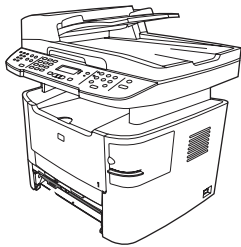

7. Reinsert tray 2.

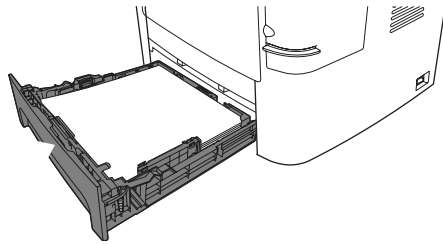

8. Close the rear output bin, and then open the automatic two-sided path door on the back of the product.

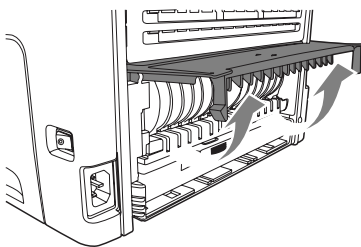

9. With both hands, grasp the side of the media that is most visible (this includes the middle), and carefully pull it free from the product.

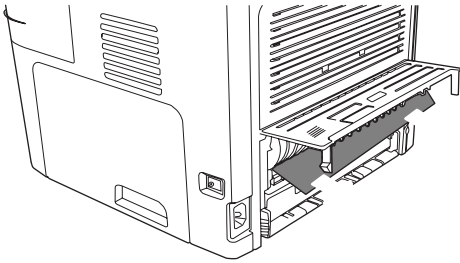

10. Close the automatic two-sided path door.

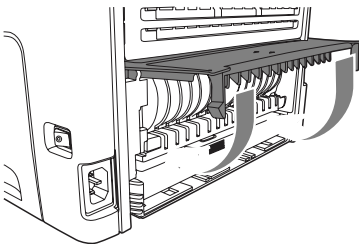

## Clear jams from the output-bin areas

### Top (face-down) output bin

---

**CAUTION:** Do not use sharp objects, such as tweezers or needle-nose pliers, to remove jams. Damages caused by sharp objects are not covered by the warranty.

---

With both hands, grasp the side of the media that is most visible (this includes the middle), and carefully pull it free from the product.

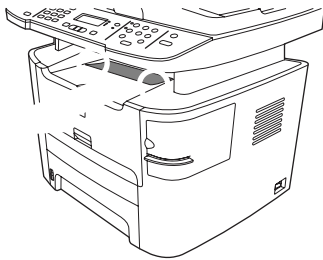



## Rear (face-up) output bin

**CAUTION:** Do not use sharp objects, such as tweezers or needle-nose pliers, to remove jams. Damages caused by sharp objects are not covered by the warranty.

1. Open the straight-through output door.

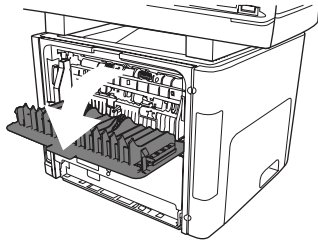

2. Rotate the green pressure-release levers downward.

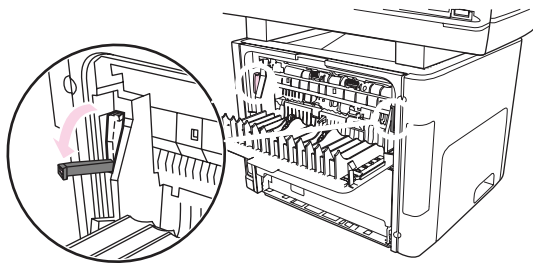

3. With both hands, grasp the side of the media that is most visible (this includes the middle), and carefully pull it free from the printer.

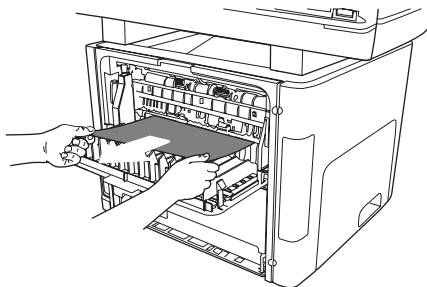

 **NOTE:** If you cannot grasp the media with your hands, perform the procedure in [Clear jams from the print-cartridge area on page 188](#).

4. Close the straight-through output door.

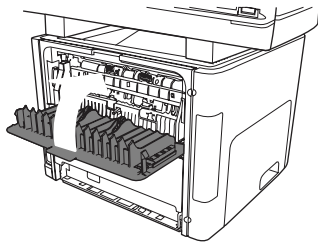

## Clear jams from the print-cartridge area

**CAUTION:** Do not use sharp objects, such as tweezers or needle-nose pliers, to remove jams. Damages caused by sharp objects are not covered by the warranty.

When removing jammed media, pull the jammed media straight away from the product. Pulling jammed media out of the product at an angle can damage the product.

1. Open the print-cartridge door, and then remove the print cartridge.

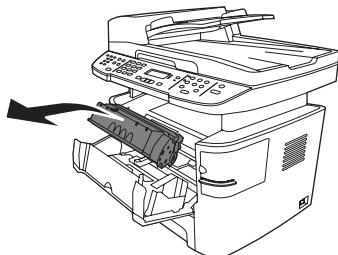

△ **CAUTION:** To prevent damage to the print cartridge, minimize its exposure to direct light.

2. Open the rear output door, and then rotate the green pressure-release levers downward.

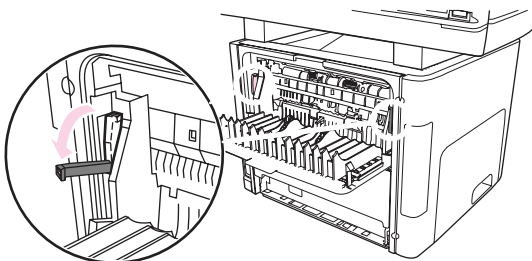

3. With both hands, grasp the side of the media that is most visible (this includes the middle), and carefully pull it free from the product.

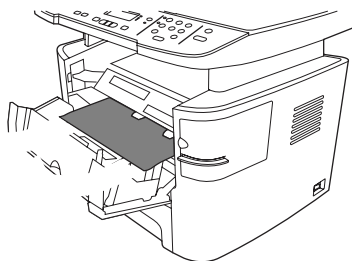

4. Replace the print cartridge and close the print-cartridge door.

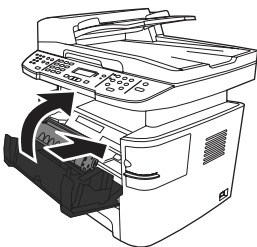

5. Close the rear output door.

## Clear jams from the convenience stapler (HP LaserJet M2727nfs MFP only)

To reduce the risk of staple jams, make sure that you staple 20 or fewer pages of media (80 g/m<sup>2</sup> or 20 lb) at a time.

1. Turn off the HP LaserJet M2727nfs MFP, and then open the stapler door.

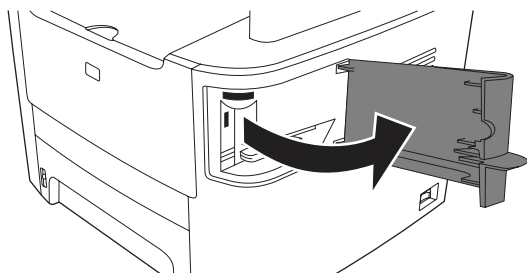

 **NOTE:** Opening the stapler door disables the stapler.

2. Remove the staple cassette from the product.

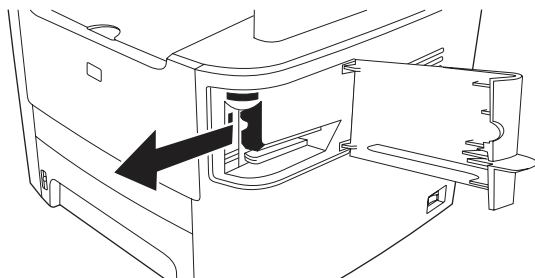

3. Clear any loose staples from the stapler and from the staple cassette.

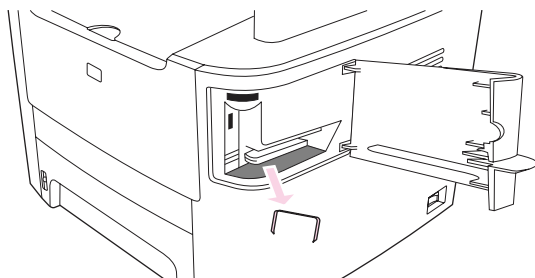

4. Replace the staple cassette.

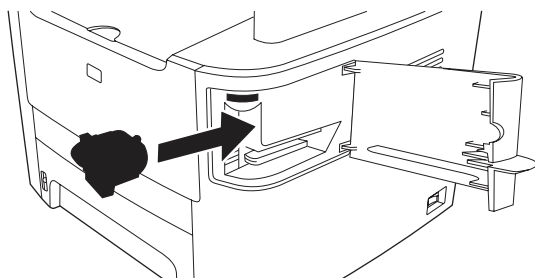

5. Close the stapler door, and then turn on the product.

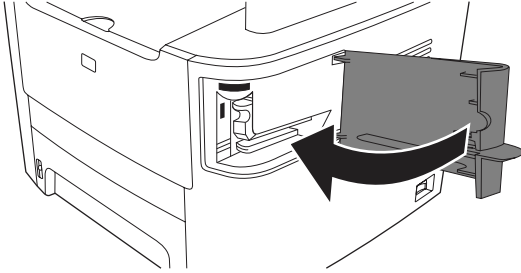

6. Insert media to test the convenience stapler. Repeat steps 1 through 6 if necessary.

## Avoid repeated jams

- Verify that the input tray is not overfilled. The input tray capacity varies depending on the type of print media that you are using.
- Verify that the media guides are properly adjusted.
- Check that the input tray is securely in place.
- Do not add print media to the input tray while the product is printing.
- Use only HP-recommended media types and sizes. See [Media specifications on page 16](#) for more information about print media types.
- Do not fan the media prior to loading it in a tray. To loosen the ream, hold it firmly in both hands and twist the media by rotating your hands in the opposite direction.
- Do not let print media stack up in the output bin. The print media type and the amount of toner used affect the output bin capacity.
- Check the power connection. Make sure that the power cord is firmly connected to both the product and the power supply box. Plug the power cord into a grounded power outlet.
- Do not use media has already passed through the product print path.
- Do not use media that is damaged or has foreign objects attached to it, such as staples or paper clips.

# Control-panel menus

## Use the control-panel main menus

To gain access to the control-panel main menus, use the following steps.

 **NOTE:** For information about the control-panel secondary menus, see [Control-panel secondary menus on page 199](#).

1. Press **Setup**.
2. Use the arrow buttons to navigate the listings.
  - Press **OK** to select the appropriate option.
  - Press **Cancel** to cancel an action or return to the Ready state.

## Control-panel main menus

These menus are available from the control-panel main menu:

- Use the **Fax Job status** menu to display a list of all faxes that are waiting to be sent, or have been received but are waiting to be printed, forwarded, or uploaded to the computer.
- Use the **Fax functions** menu to configure fax functions such as scheduling a delayed fax, cancelling the **Receive to PC** mode, reprinting faxes that were previously printed, or printing faxes that are stored in memory.
- Use the **Copy setup** menu to configure basic copy default settings such as contrast, collation, or the number of copies printed.
- Use the **Reports** menu to print reports that provide information about the product.
- Use the **Fax setup** menu to configure the fax phone book, the outgoing and incoming fax options, and the basic settings for all faxes.
- Use the **System setup** menu to establish basic product settings such as language, print quality, or volume levels.
- Use the **Network config** menu to configure network settings such as TCP/IP configuration.
- Use the **Service** menu to restore default settings, clean the product, and activate special modes that affect print output.

 **NOTE:** To print a detailed list of the entire control-panel menu and its structure, print a menu map. See [Product information pages and reports on page 237](#).

**Table 6-4 Fax Job status menu**

| Menu item      | Description   |
|----------------|---|
| Fax Job status | Displays pending fax jobs, and allows you to cancel pending fax jobs. |

**Table 6-5 Fax functions menu**

| Menu item      | Description                                       |
|----------------|---|
| Send fax later | Allows a fax to be sent at a later time and date. |

**Table 6-5 Fax functions menu (continued)**

| Menu item         | Description   |
|-------------------|---|
| Stop Recv to PC   | Disables the <b>Receive to PC</b> setting that allows a computer to upload all current faxes that have not been printed and all future faxes received by the product. |
| Reprint last      | Reprints the faxes that are stored in the product memory.   |
| Polling receive   | Allows the product to call another fax machine that has polling send enabled.   |
| Clear saved faxes | Clears all faxes in the product memory.   |

**Table 6-6 Copy setup menu**

| Menu item                | Sub-menu item                            | Description  |
|--------------------------|--|--|
| <b>Default Quality</b>   | <b>Mixed</b>                             | Sets the default copy quality.   |
|                          | <b>Picture</b>                           |  |
|                          | <b>Film photo</b>                        |  |
|                          | <b>Text</b>                              |  |
| <b>Def. light/dark</b>   |  | Sets the default contrast option.  |
| <b>Def. Collation</b>    | <b>On</b>                                | Sets the default collation option.   |
|                          | <b>Off</b>                               |  |
| <b>Def. # of copies</b>  | (Range: 1-99)                            | Sets the default number of copies.   |
| <b>Def. Reduce/Enlrg</b> | <b>Original=100%</b>                     | Sets the default percentage to reduce or enlarge a copied document.  |
|                          | <b>Lgl-&gt;Ltr=78%</b>                   |  |
|                          | <b>Lgl-&gt;A4=83%</b>                    |  |
|                          | <b>A4-&gt;Ltr=94%</b>                    |  |
|                          | <b>Ltr-&gt;A4=97%</b>                    |  |
|                          | <b>Full Page=91%</b>                     |  |
|                          | <b>Fit to page</b>                       |  |
|                          | <b>2 pages/sheet</b>                     |  |
| <b>Def. Tray Select</b>  | <b>Auto select</b>                       | Sets the default input paper tray.   |
|                          | <b>Tray 1</b>                            |  |
|                          | <b>Tray 2</b>                            |  |
|                          | <b>Tray 3 (if the tray is installed)</b> |  |
| <b>Default 2-sided</b>   | <b>1 to 1 sided</b>                      | Sets the default input scan format and the default output format. Two-sided printing is supported from the ADF only. |
|                          | <b>1 to 2 sided</b>                      |  |
|                          | <b>2 to 2 sided</b>                      |  |
|                          | <b>2 to 1 sided</b>                      |  |

**Table 6-6 Copy setup menu (continued)**

| Menu item        | Sub-menu item | Description  |
|------------------|---------------|--|
| Def. Copy Draft  | On            | Sets the default draft mode option.                              |
|                  | Off           |  |
| Def. Multi-page  | On            | Sets the default multi-page flatbed copy option.                 |
|                  | Off           |  |
| Restore defaults |               | Sets all customized copy settings to the factory default values. |

**Table 6-7 Reports menu**

| Menu Item      | Sub-menu item    | Sub-menu item  | Description   |
|----------------|------------------|----------------|---|
| Demo page      |                  |                | Prints a page that demonstrates print quality.  |
| Fax Reports    | Fax Confirmation | Never          | Sets whether or not the product prints a confirmation report after a successful sending or receiving job.   |
|                |                  | Every fax      |   |
|                |                  | Send fax only  |   |
|                |                  | Receive fax    |   |
|                | Include 1st page | On             | Sets whether or not the product includes a thumbnail image of the first page of the fax on the report.  |
|                |                  | Off            |   |
|                | Fax Error Report | Every error    | Sets whether or not the product prints a report after a failed sending or receiving job.  |
|                |                  | Send Error     |   |
|                |                  | Receive Error  |   |
|                |                  | Never          |   |
|                | Last Call Report |                | Prints a detailed report of the last fax operation, either sent or received.  |
|                | Fax Activity log | Print log now  | <b>Print log now:</b> Prints a list of the faxes that have been sent from or received by this product.  |
|                |                  | Auto Log Print |   |
|                | PhoneBook report |                | Prints a list of the speed dials that have been set up for this product.  |
|                | Block Fax list   |                | Prints a list of phone numbers that are blocked from sending faxes to this product.   |
|                | Billing report   |                | Prints a list of billing codes that have been used for outgoing faxes. This report shows how many sent faxes were billed to each code. This menu item appears only when the billing codes feature is turned on. |
|                | All fax reports  |                | Prints all fax-related reports.   |
| Menu structure |                  |                | Prints a control-panel menu layout map. The active settings for each menu are listed.   |

**Table 6-7 Reports menu (continued)**

| Menu Item              | Sub-menu item | Sub-menu item | Description  |
|------------------------|---------------|---------------|--|
| <b>Config report</b>   |               |               | Prints a list of all the product settings. Includes network information when the product is connected to the network.  |
| <b>Supplies status</b> |               |               | Prints the print-cartridge status. Includes the following information: <ul style="list-style-type: none"> <li>• Estimated pages remaining</li> <li>• Serial number</li> <li>• Number of pages printed</li> </ul> |
| <b>Network report</b>  |               |               | Displays status for: <ul style="list-style-type: none"> <li>• Network hardware configuration</li> <li>• Enabled features</li> <li>• TCP/IP and SNMP information</li> <li>• Network statistics</li> </ul>         |
| <b>Usage page</b>      |               |               | Displays the number of pages printed, faxed, copied, and scanned by the product.   |
| <b>PCL font list</b>   |               |               | Prints a list of all installed PCL 5 fonts.  |
| <b>PS font list</b>    |               |               | Prints a list of all installed PS fonts.   |
| <b>PCL6 font list</b>  |               |               | Prints a list of all installed PCL 6 fonts.  |
| <b>Service page</b>    |               |               | Displays supported paper types, copy settings, and miscellaneous product settings.   |

**Table 6-8 Fax setup menu**

| Menu Item         | Sub-menu item           | Sub-menu item          | Description  |
|-------------------|-------------------------|------------------------|--|
| <b>Fax Header</b> | <b>Your fax number</b>  |                        | Sets the identifying information that is sent to the receiving product.  |
|                   | <b>Company name</b>     |                        |  |
| <b>Phone Book</b> | <b>Individual setup</b> | <b>Add/Edit</b>        | Edits the fax phone book speed dials and group-dial entries. The product supports up to 120 phone book entries, which can be either individual or group entries. |
|                   |                         | <b>Delete</b>          |  |
|                   | <b>Group setup</b>      | <b>Add/Edit group</b>  |  |
|                   |                         | <b>Delete group</b>    |  |
|                   |                         | <b>Del. # in group</b> |  |
| <b>Delete all</b> |                         |                        |  |



**Table 6-8 Fax setup menu (continued)**

| <b>Menu Item</b>        | <b>Sub-menu item</b>    | <b>Sub-menu item</b>   | <b>Description</b>   |
|-------------------------|-------------------------|--|--|
| <b>Fax Send setup</b>   | <b>Def. Resolution</b>  | <b>Fine</b>  | Sets the resolution for sent documents. Higher resolution images have more dots per inch (dpi), so they show more detail. Lower resolution images have fewer dots per inch and show less detail, but the file size is smaller. |
|                         |                         | <b>Superfine</b>   |  |
|                         |                         | <b>Photo</b>   |  |
|                         |                         | <b>Standard</b>  |  |
|                         | <b>Def. light/dark</b>  |  | Sets the darkness of outgoing faxes.   |
|                         | <b>Def. glass size</b>  | <b>Letter</b>  | Sets the default paper size for documents being scanned from the flatbed scanner.  |
|                         |                         | <b>A4</b>  |  |
|                         | <b>Dialing Mode</b>     | <b>Tone</b>  | Sets whether the product should use tone or pulse dialing.   |
|                         |                         | <b>Pulse</b>   |  |
|                         | <b>Redial if busy</b>   | <b>On</b>  | Sets whether or not the product should attempt to redial if the line is busy.  |
|                         |                         | <b>Off</b>   |  |
|                         | <b>Redial-no answer</b> | <b>On</b>  | Sets whether the product should attempt to dial if the recipient fax number does not answer.   |
|                         |                         | <b>Off</b>   |  |
| <b>Redial Comm Err.</b> | <b>On</b>               | Sets whether the product should attempt to redial the recipient fax number if a communication error occurs.                                |  |
|                         | <b>Off</b>              |  |  |
| <b>Dial Prefix</b>      | <b>On</b>               | Specifies a prefix number that must be dialed when sending faxes from the product.   |  |
|                         | <b>Off</b>              |  |  |
| <b>Detect dial tone</b> | <b>On</b>               | Sets whether the product should check for a dial tone before sending a fax.  |  |
|                         | <b>Off</b>              |  |  |
| <b>Billing codes</b>    | <b>On</b>               | Enables the use of billing codes when set to <b>On</b> . A prompt will appear that asks you to enter the billing code for an outgoing fax. |  |
|                         | <b>Off</b>              |  |  |

**Table 6-8 Fax setup menu (continued)**

| Menu Item              | Sub-menu item           | Sub-menu item               | Description   |
|------------------------|-------------------------|-----------------------------|---|
| <b>Fax Recv. setup</b> | <b>Answer mode</b>      | <b>Automatic</b>            | <p>Sets the type of answer mode. The following options are available:</p> <ul style="list-style-type: none"> <li>● <b>Automatic:</b> The product automatically answers an incoming call on the configured number of rings.</li> <li>● <b>TAM:</b> A telephone answering machine (TAM) is attached to the Aux phone port of the product. The product will not pick up any incoming call, but only listen for fax tones after the answering machine has picked up the call.</li> <li>● <b>Fax/Tel:</b> The product must automatically pick up the call and determine if the call is a voice or fax call. If the call is a fax call, the product handles the call as usual. If the call is a voice call, an audible synthesized ring is generated to alert the user of an incoming voice call.</li> <li>● <b>Manual :</b> The user must press the <b>Start Fax</b> button or use an extension phone to make the product answer the incoming call.</li> </ul> |
|                        |                         | <b>TAM</b>                  |   |
|                        |                         | <b>Fax/Tel</b>              |   |
|                        |                         | <b>Manual</b>               |   |
|                        | <b>Rings to answer</b>  | (Range of 1-9)              | Sets the number of rings that must occur before the fax modem answers.  |
|                        | <b>Answer Ring Type</b> | <b>All Rings</b>            | <p>Allows a user to have two or three phone numbers on a single line, each with a different ring pattern (on a phone system with distinctive-ring service).</p> <ul style="list-style-type: none"> <li>● <b>All Rings:</b> The product answers any calls that come through the telephone line.</li> <li>● <b>Single:</b> The product answers any calls that produce a single-ring pattern.</li> <li>● <b>Double:</b> The product answers any calls that produce a double-ring pattern.</li> <li>● <b>Triple:</b> The product answers any calls that produce a triple-ring pattern.</li> <li>● <b>Double&amp;Triple:</b> The product answers any calls that produce a double-ring or triple-ring pattern.</li> </ul>   |
| <b>Single</b>          |                         |                             |   |
| <b>Double</b>          |                         |                             |   |
| <b>Triple</b>          |                         |                             |   |
|                        |                         | <b>Double&amp;Triple</b>    |   |
|                        | <b>Extension Phone</b>  | <b>On</b><br><br><b>Off</b> | When this feature is enabled, press the <b>1-2-3</b> buttons on the extension phone to cause the product to answer an incoming fax call.  |
|                        | <b>Silence Detect</b>   | <b>On</b><br><br><b>Off</b> | Sets whether the product can receive faxes from older model fax machines that do not emit the initial fax tones used during fax transmission.   |
|                        | <b>Fit to page</b>      | <b>On</b><br><br><b>Off</b> | Shrinks faxes that are larger than Letter-size or A4-size so that they can fit onto a Letter-size or A4-size page. If this feature is set to <b>Off</b> , faxes larger than Letter or A4 will print on multiple pages.  |
|                        | <b>Stamp faxes</b>      | <b>On</b><br><br><b>Off</b> | Sets product to add the date, time, sender's phone number, and page number to each page of the faxes that this product receives.  |
|                        | <b>Forward fax</b>      | <b>On</b><br><br><b>Off</b> | Sets product to send all received faxes to another fax machine.   |

**Table 6-8 Fax setup menu (continued)**

| Menu Item        | Sub-menu item           | Sub-menu item   | Description  |
|------------------|-------------------------|---|--|
|                  | <b>Block faxes</b>      | <b>Add entry</b><br><b>Delete entry</b><br><b>Clear all</b>   | Modifies the blocked fax list. The blocked fax list can contain up to 30 numbers. When the product receives a call from one of the blocked fax numbers, it deletes the incoming fax. It also logs the blocked fax in the activity log along with job-accounting information.   |
|                  | <b>Private receive</b>  | <b>On</b><br><b>Off</b>                                       | Setting <b>Private receive</b> to <b>On</b> requires the user to have set a password in product security. After the password is set, the following options are set: <ul style="list-style-type: none"> <li>• <b>Private receive</b> is turned on.</li> <li>• All old faxes are deleted from memory.</li> <li>• <b>Fax forwarding</b> or <b>Receive to PC</b> are set to <b>Off</b>.</li> <li>• All incoming faxes are stored in memory.</li> </ul> |
|                  |                         | <b>Print faxes</b>  | Prints stored faxes when the private-receive feature is on. This menu item appears only when the private-receive feature is turned on.   |
|                  | <b>Reprint faxes</b>    | <b>On</b><br><b>Off</b>                                       | Sets whether all received faxes stored in available memory can be reprinted.   |
|                  | <b>F/T ring time</b>    | <b>20</b><br><b>30</b><br><b>40</b><br><b>70</b>              | Sets when the product should stop sounding the <b>Fax/Tel</b> audible ring to notify the user of an incoming voice call.   |
|                  | <b>Print duplex</b>     | <b>On</b><br><b>Off</b>                                       | Sets whether all received faxes are printed using both sides of the paper.   |
| <b>All faxes</b> | <b>Error correction</b> | <b>On</b><br><b>Off</b>                                       | Sets whether the product sends or receives the error portion again when a fax transmission error occurs.   |
|                  | <b>Fax Speed</b>        | <b>Fast(V.34)</b><br><b>Medium(V.17)</b><br><b>Slow(V.29)</b> | Increases or decreases the allowed fax communication speed.  |

**Table 6-9 System setup menu**

| Menu Item       | Sub-menu item  | Sub-menu item | Description   |
|-----------------|--|---------------|---|
| <b>Language</b> | (List of available control-panel display languages.) |               | Sets the language in which the control panel displays messages and product reports. |

**Table 6-9 System setup menu (continued)**

| Menu Item        | Sub-menu item  | Sub-menu item                | Description  |
|------------------|--|------------------------------|--|
| Paper setup      | Def. paper size  | Letter                       | Sets the size for printing internal reports or any print job that does not specify a size.   |
|                  |  | A4                           |  |
|                  |  | Legal                        |  |
|                  | Def. paper type  | Lists available media types. | Sets the type for printing internal reports or any print job that does not specify a type.   |
|                  | Tray 1   | Paper type                   | Sets the default size and type for tray 1.   |
|                  | Tray 2   | Paper size                   | Sets the default size and type for tray 2.   |
| Paper out action | Tray 3   |                              | Sets the default size and type for optional tray 3. This menu item appears only if tray 3 is installed.  |
|                  |  | Wait forever                 | Determines how the product reacts when a print job requires a media size or type that is unavailable or when a specified tray is empty. <ul style="list-style-type: none"> <li>Select <b>Wait forever</b> to make the product wait until the correct media is loaded.</li> <li>Select <b>Override</b> to print on a different size paper after a specified delay.</li> <li>Select <b>Cancel</b> to automatically cancel the print job after a specified delay.</li> <li>If either <b>Override</b> or <b>Cancel</b> is chosen, the control panel prompts for the number of seconds to delay. Use the arrow keys to either decrease the time or increase the time up to 3600 seconds.</li> </ul> |
|                  |  | Cancel                       |  |
|                  |  | Override                     |  |
| Print quality    | Cartridge low  | (Range of 1-20)              |  |
| Replace supplies | Stop at Out  |                              | Sets how the product reacts when it detects that the print cartridge is out.   |
|                  | Override out   |                              |  |
| Print Density    | (Range of 1-5)   |                              | Sets how much toner the product should apply to thicken lines and edges.   |
| Volume settings  | Alarm volume   | Soft                         | Sets the volume levels for the product.  |
|                  | Ring volume  | Medium                       |  |
|                  | Key-press volume   | Loud                         |  |
|                  | Phoneline volume   | Off                          |  |
| Time/Date        | (Settings for time format, current time, date format, and current date.) |                              | Sets the time and date setting for the product.  |
| Product security | On   |                              | Sets the product-security feature. When the setting is set to <b>On</b> , you must set a personal identification number (PIN).   |
|                  | Off  |                              |  |
| Courier font     | Regular  |                              | Sets Courier font values.  |
|                  | Dark   |                              |  |

**Table 6-10 Service menu**

| Menu item               | Sub-menu item         | Description   |
|-------------------------|-----------------------|---|
| <b>Print T.30 trace</b> | <b>Never</b>          | Prints or schedules a report that is used to problem solve fax transmission issues.   |
|                         | <b>If error</b>       |   |
|                         | <b>At end of call</b> |   |
|                         | <b>Now</b>            |   |
| <b>Cleaning mode</b>    |                       | Cleans the product when specks or other marks appear on printed output. The cleaning process removes dust and excess toner from the paper path.   |
|                         |                       | When selected, the product prompts you to load plain Letter or A4 paper in tray 1. Press <b>OK</b> to begin the cleaning process. Wait until the process completes. Discard the page that prints. |
| <b>USB speed</b>        | <b>High</b>           | Sets the USB speed.   |
|                         | <b>Full</b>           |   |
| <b>Less paper curl</b>  |                       |   |

## Control-panel secondary menus

Use the **Secondary service** and **Developer's** menus to perform various tests and print service reports.

### Use the control-panel secondary menus

To gain access to the control-panel secondary menus, use the following steps.

1. Press **Setup**.
2. Press the Left arrow (<) and **Cancel** buttons at the same time.

 **NOTE:** Some control panels might require that the Left arrow (<) be pressed slightly before the **Cancel** button.

3. Press **Setup**.
4. Use the arrow buttons to navigate the listings.
5. Press **OK** to select the appropriate option, or Press **Cancel** to cancel an action or return to the Ready state.

### Control-panel secondary menus

These menus are available from the control-panel secondary menu:

- Use the **Secondary service** menu to print service reports, calibrate the scanner, reset the telecom country/region location, test the control-panel display, and view the firmware version.
- Use the **Developer's** menu to test telecom settings, enter scanner settings, adjust fax data-store parameters, and print developer's reports.

### To adjust fax data-store parameters

When you adjust fax data-store parameters, the product does not alert you to incorrect input values. Changing fax data-store parameters and render the product illegal or inoperable.

1. On the developer's menu, use the arrow buttons to navigate to **R/W Parameter**, and then press **OK**.
2. Use the arrow buttons to locate the parameter that you want to change. The current setting appears on the control-panel display.
3. Type the new value for the fax data-store parameter, and then press **OK**.

### To print a list of all the Fax data-store parameters

1. From the developer's menu select **Dev. Reports**.
2. Use the arrow buttons to select **DS Fax**, and then press **OK**.

### To change the telecom country/region setting

Three situation can occur that necessitate changing the country/region settings for the product.

- The customer has moved to a different country/region from where the product was purchased.
- The information has been erased because of a NVRAM initialization, or parameters are set to "undefined."
- The formatter was replaced.

1. On the developer's menu, use the arrow buttons to navigate to **R/W Parameter**, and then press **OK**.
2. Press **3**.
3. When the message **LIU COUNTRY** appears on the control-panel display, press **OK**.
4. Type the new telecom country/region number, and then press **OK**.
5. After the product returns to the Ready state, turn the power off, and then on.

**Table 6-11 Secondary service menu**

| Menu item       | Sub-menu item   | Sub-menu item                    |
|-----------------|-----------------|----------------------------------|
| Service Reports | Cont. Self-Test | Cont. Self-Test [Cancel] to stop |
|                 | Extended Keymap |                                  |
|                 | Error Report    |                                  |

**Table 6-11 Secondary service menu (continued)**

| Menu item        | Sub-menu item                       | Sub-menu item               |
|------------------|-------------------------------------|-----------------------------|
| Scan Calibration | Calibrate                           | Calibrate 300 mono copy     |
|                  |                                     | Calibrate 600 scan to host  |
|                  |                                     | Calibrate 1200 scan to host |
|                  | Corrected                           | Corrected 300 mono copy     |
|                  |                                     | Corrected 600 scan to host  |
|                  |                                     | Corrected 1200 scan to host |
|                  | Tables                              | Tables Debug On             |
|                  |                                     | Tables Debug Off            |
|                  |                                     | Tables Mono Tonemaps        |
|                  | Location                            | USA                         |
| Yes              |                                     |                             |
| Display test     | LED test, show: <LED name>          |                             |
|                  | .....                               |                             |
|                  | Line 1 test                         |                             |
|                  | Line 2 test                         |                             |
|                  | .....                               |                             |
|                  | Display ###-###<br>@@@@@@@@@@@@@@@@ |                             |
| Button test      | Key test: press <key name>          |                             |
| Show FW Version  |                                     |                             |
| Ethernet reset   |                                     |                             |

**Table 6-12 Developer's menu**

| Menu item       | Sub-menu item                | Sub-menu item |
|-----------------|------------------------------|---------------|
| Read Register   | Enter Register #####         |               |
| Write Register  | Enter Register #####         |               |
|                 | Enter Reg. Value #####       |               |
| Enter MAC Addr. | Enter MAC Addr. XXXXXXXXXXXX |               |

**Table 6-12 Developer's menu (continued)**

| Menu item                                    | Sub-menu item  | Sub-menu item                       |
|--|--|-------------------------------------|
| <b>Scanner Settings</b>                      | <b>Scan Test Mode</b>  | <b>Configure for scan test mode</b> |
|  | <b>ADF Starve Start</b>  | <b>ADF Starve Start (0–16)</b>      |
|  |  | <b>ADF Starve Start [value]</b>     |
|  | <b>ADF Starve Run</b>  | <b>ADF Starve Run (0–16)</b>        |
|  |  | <b>ADF Starve Run [value]</b>       |
|  | <b>Flatbed Starve Start</b>  | <b>FB Starve Start (0–16)</b>       |
|  |  | <b>FB Starve Run [value]</b>        |
|  | <b>Flatbed Starve Run</b>  | <b>FB Starve Run (0–16)</b>         |
|  |  | <b>FB Starve Run [value]</b>        |
|  |  | <b>Drop Bogey</b>                   |
|  | <b>Park Scanner</b>  |                                     |
| <b>Formatter Test</b>                        | <b>Configuring for formatter test</b>  |                                     |
| <b>REINIT FFS</b>                            |  |                                     |
| Reinitialize fax file system                 |  |                                     |
| <b>R/W Parameter</b>                         | For information about this setting see, <a href="#">To adjust fax data-store parameters on page 200</a> and <a href="#">To change the telecom country/region setting on page 200</a> . |                                     |
| <b>Monitor Test</b>                          | <b>Onhook Monitor</b>  |                                     |
|  | <b>Offhook Monitor</b>   |                                     |
|  | <b>EavesdropMonitor</b>  |                                     |
|  | <b>SigPower Monitor</b>  |                                     |
| <b>LIU Test</b>                              | <b>LIU Inputs</b>  |                                     |
|  | <b>LIU ID</b>  |                                     |
| <b>Loopback Test</b>                         |  |                                     |
| <b>Transmit Test</b>                         | <b>OFFHOOK</b>   |                                     |
|  | <b>ONHOOK</b>  |                                     |
|  | <b>DIAL NUMBER</b>   |                                     |
| <b>Dev. Reports</b><br>(Developer's Reports) | <b>DS Fax</b>  |                                     |
|  | <b>DS No Fax</b>   |                                     |
|  | <b>Translations</b>  |                                     |
|  | <b>Location codes</b>  |                                     |
|  | <b>Error Diffusion</b>   |                                     |



**Table 6-12 Developer's menu (continued)**

| Menu item       | Sub-menu item | Sub-menu item |
|-----------------|---------------|---------------|
| Clock Dithering | On            |               |
|                 | Off           |               |
| Pick and Kick   |               |               |

# Print problems

## Print-quality problems

The information in the following sections helps you identify and resolve print-quality issues.

---

 **NOTE:** If you are having copy problems, see [Copy problems on page 214](#).

---

### Improve print quality

Use the print-quality settings to prevent print-quality problems.

#### Print-quality settings

Print-quality settings affect how light or dark the print is on the page and the style in which the graphics are printed. You can also use the print-quality settings to optimize the print quality for a specific media type.

You can change the settings in the product properties to accommodate the types of jobs that you are printing. The following settings are available, depending on the printer driver that you are using:

- **600 dpi**
- **FastRes 1200**
- ProRes1200 (132 lpi)
- ProRes1200 (180 lpi)

---

 **NOTE:** Changing the resolution can change the formatting of your text.

---

#### To temporarily change print-quality settings

To change the print-quality settings only for the current software program, open the print properties through the **Print Setup** menu in the program that you are using to print.

#### To change print-quality settings for all future jobs

---

 **NOTE:** For Macintosh instructions, see the user guide.

---

For Windows 98, Windows 2000, and Windows Me:

1. In the Windows system tray, click **Start**, select **Settings**, and then click **Printers**.
2. Right-click the product icon.
3. Click **Properties** (in Windows 2000, you can also click **Printing Preferences**).
4. Change the settings, and then click **OK**.

For Windows XP:

1. In the Windows system tray, click **Start**, click **Control Panel**, and then click **Printers and Faxes**.
2. Right-click the product icon.

3. Click **Properties**, or click **Printing Preferences**.
4. Change the settings, and click **OK**.

## Identify and correct print defects

Use the checklist and print-quality issues charts in this section to solve print-quality problems.

### Print-quality checklist

General print-quality problems can be solved by using the following checklist:

1. Make sure that the paper or print media that you are using meets specifications. Generally, smoother paper provides better results.
2. If you are using a special print media such as labels, transparencies, glossy paper, or letterhead, ensure that you have configured the product to printed by the correct type.
3. Print a Configuration page and Supplies Status page from the product control panel.
  - Check the Supplies Status page to see if any supplies are low or empty. No information is provided for non-HP print cartridges.
4. Print a Demo page from the HP ToolboxFX. If the page prints, the problem is with the printer driver. Try printing from another printer driver. For example, if you are using the PCL 6 printer driver, print from the PS printer driver.
  - Use the Add Printer Wizard in the **Printers** (or **Printers and Faxes** in Windows XP) dialog box to install the PS driver.
5. Try printing from a different program. If the page prints correctly, the problem is with the program from which you were printing.
6. Restart the computer and the product and try printing again. If the problem is not resolved, see [General print-quality issues on page 205](#).

### General print-quality issues

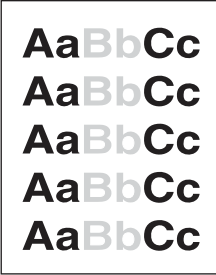
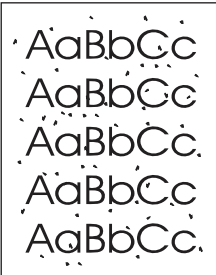
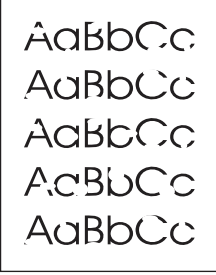
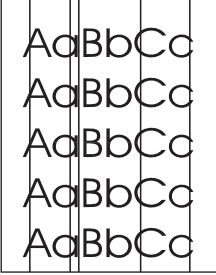

The following examples depict letter-size paper that has passed through the product short-edge-first. These examples illustrate problems that would affect all of the pages that you print. The examples include the typical cause and solution for each of these problems.

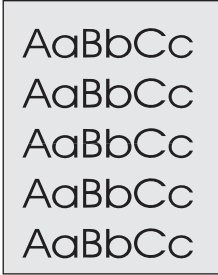
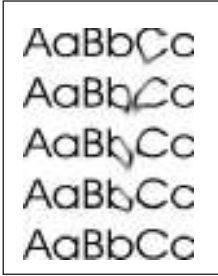
| Problem                                       | Example   | Cause  | Solution   |
|---|---|--|--|
| Print is light or faded.                      |    | <p>The media might not meet HP specifications.</p> <hr/> <p>The print cartridge might be low. If you use a non-HP print cartridge, no messages appear on the product control panel or in the HP ToolboxFX.</p> <hr/> <p>If the whole page is light, the print density adjustment is too light or EconoMode might be turned on.</p> | <p>Use media that meets HP specifications. Make sure that the media meets specifications in the <i>HP LaserJet Printer Family Print Media Guide</i>.</p> <hr/> <p>Replace the print cartridge. See <a href="#">Remove the print cartridge on page 99</a>.</p> <p>If the print cartridge is not low or empty, inspect the transfer roller to see if it is damaged. If it is not, replace the print cartridge.</p> <hr/> <p>Adjust the print density, and disable EconoMode in the product Properties.</p> |
| Toner specks appear.                          |    | <p>The media might not meet HP specifications.</p> <hr/> <p>The paper path might need to be cleaned.</p>   | <p>Use media that meets HP specifications. Make sure that the media meets specifications in the <i>HP LaserJet Printer Family Print Media Guide</i>.</p> <hr/> <p>Clean the paper path. See <a href="#">Clean the paper path on page 56</a>, or see the HP ToolboxFX online Help.</p>  |
| Dropouts appear.                              |  | <p>A single sheet of print media might be defective.</p> <hr/> <p>The moisture content of the paper is uneven or the paper has moist spots on its surface.</p> <hr/> <p>The paper lot is flawed. The manufacturing processes can cause some areas to reject toner.</p> <hr/> <p>The print cartridge might be defective.</p>        | <p>Try reprinting the job.</p> <hr/> <p>Try different paper, such as high-quality paper that is intended for laser printers.</p> <hr/> <p>Try different paper, such as high-quality paper that is intended for laser printers.</p> <hr/> <p>Replace the print cartridge. See <a href="#">Remove the print cartridge on page 99</a>.</p>  |
| Vertical streaks or bands appear on the page. |  | <p>The print cartridge might be low or defective. If you are using a non-HP print cartridge, no messages appear on the product control panel or in the HP ToolboxFX.</p>   | <p>Replace the print cartridge. See <a href="#">Remove the print cartridge on page 99</a>.</p>   |

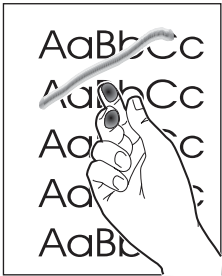
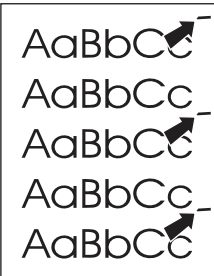
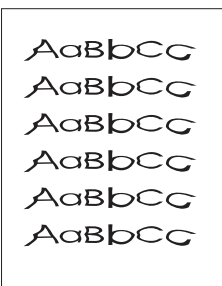
| Problem  | Example  | Cause  | Solution   |
|--|--|--|--|
| The amount of background toner shading becomes unacceptable. |   | The media might not meet HP specifications.  | Use a different paper with a lighter basis weight.   |
|  |  | The single-sheet priority input slot (tray 1) might be installed incorrectly.  | Make sure that the single-sheet priority input slot (tray 1) is in place.  |
|  |  | The print-density setting is too high.   | Decrease the print-density setting through HP ToolboxFX or the embedded Web server. This decreases the amount of background shading.               |
|  |  | Very dry (low humidity) conditions can increase the amount of background shading.  | Check the product environment.   |
|  |  | The print cartridge might be low. If you are using a non-HP print cartridge, no messages appear on the product control panel or in the HP ToolboxFX. | Replace the print cartridge. See <a href="#">Remove the print cartridge on page 99</a> .   |
| Toner smears appear on the media.                            |  | The media might not meet HP specifications.  | Use media that meets HP specifications. Make sure that the media meets specifications in the <i>HP LaserJet Printer Family Print Media Guide</i> . |
|  |  | If toner smears appear on the leading edge of the paper, the media guides are dirty, or debris has accumulated in the print path.                    | Clean the media guides and the paper path. See <a href="#">Clean the product on page 49</a> .  |
|  |  | The print cartridge might be low. If you are using a non-HP print cartridge, no messages appear on the product control panel or in the HP ToolboxFX. | Replace the print cartridge. See <a href="#">Remove the print cartridge on page 99</a> .   |
|  |  | The fuser temperature might be too low.  | In the printer driver, make sure the appropriate media type is selected.   |

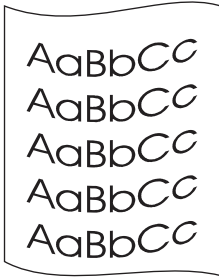
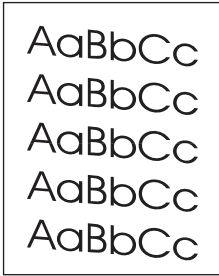
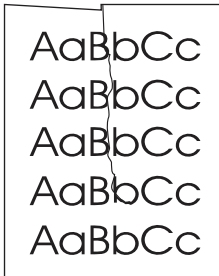
| Problem  | Example   | Cause  | Solution  |
|--|---|--|---|
| The toner smears easily when touched.                  |    | The product is not set to print on the type of media on which you want to print.                                 | In the printer driver, select the <b>Paper</b> tab and set <b>Type is</b> to match the type of media on which you are printing. Print speed might be slower if you are using heavy paper. |
| Marks repeatedly appear at even intervals on the page. |   | The product is not set to print on the type of media on which you want to print.                                 | In the printer driver, make sure that the appropriate media type is selected. Print speed might be slower if you are using heavy paper.   |
| The printed page contains misformed characters.        |  | The media might not meet HP specifications.  | Use a different paper, such as high-quality paper that is intended for laser printers.  |
|  |   | If characters are incorrectly formed so that they produce a wavy effect, the laser scanner might need replacing. | Verify that the problem also occurs on the Configuration page. If so, replace the laser/scanner. See <a href="#">Laser/scanner (print engine) on page 137</a> .                           |

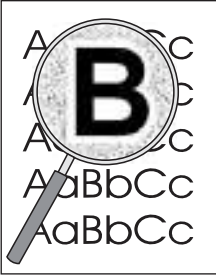
| Problem  | Example   | Cause  | Solution   |
|--|---|--|--|
| The printed page is curled or wavy.              |    | The product is not set to print on the type of media on which you want to print. | In the printer driver, make sure the appropriate media type is selected.<br><br>If the problem persists, select a media type that uses a lower fuser temperature, such as transparencies or light media.   |
|  |   | The media might have been in the input tray too long.                            | Turn over the stack of media in the tray. Also, try rotating the media 180° in the input tray.   |
|  |   | The paper path is curling the media.   | Open the rear output door to print to the straight-through output path.  |
|  |   | The media might not meet HP specifications.                                      | Use a different paper, such as high-quality paper that is intended for laser printers.   |
|  |   | Both high temperature and humidity can cause paper curl.                         | Check the product environment.   |
| Text or graphics are skewed on the printed page. |   | The media might be loaded incorrectly or the input tray might be too full.       | Verify that the media is loaded correctly and that the media guides are not too tight or too loose against the stack. See <a href="#">Load paper and print media on page 26</a> .  |
|  |   | The media might not meet HP specifications.                                      | Use a different paper, such as high-quality paper that is intended for laser printers.   |
| The printed page contains wrinkles or creases.   |  | The media might be loaded incorrectly or the input tray might be too full.       | Turn over the stack of paper in the input tray, or try rotating the paper 180° in the input tray.<br><br>Verify that the media is loaded correctly and that the media guides are not too tight or too loose against the stack. See <a href="#">Load paper and print media on page 26</a> . |
|  |   | The media might not meet HP specifications.                                      | Use a different paper, such as high-quality paper that is intended for laser printers.   |
|  |   | The paper path is curling the media.   | Open the rear output door to print to the straight-through output path.  |
|  |   | Air pockets inside envelopes can cause them to wrinkle.                          | Remove the envelope, flatten it, and try printing again.   |

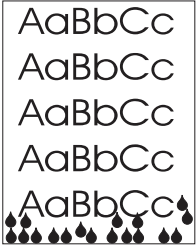
| Problem   | Example   | Cause   | Solution   |
|---|---|---|--|
| <p>Toner appears around the printed characters.</p>   |    | <p>The media might be loaded incorrectly.</p> <p>If large amounts of toner have scattered around the characters, the paper might have high resistivity.</p>                                   | <p>Turn over the stack of paper in the tray.</p> <p>Use a different paper, such as high-quality paper that is intended for laser printers.</p>   |
| <p>An image that appears at the top of the page (in solid black) repeats farther down the page (in a gray field).</p> |    | <p>Software settings might affect image printing.</p> <p>The order of images printed might affect printing.</p> <p>A power surge might have affected the product.</p>                         | <p>In your software program, change the tone (darkness) of the field in which the repeated image appears.</p> <p>In your software program, rotate the whole page 180° to print the lighter image first.</p> <p>Change the order in which the images are printed. For example, have the lighter image at the top of the page, and the darker image farther down the page.</p> <p>If the defect occurs later in a print job, turn the product off for 10 minutes, and then turn on the product to restart the print job.</p> |
| <p>Droplets of water are deposited on the trailing edge of the page.</p>  |  | <p>Moisture in the product is condensing on the fuser assembly. In excessively hot and humid areas, media retains moisture.</p> <p><b>NOTE:</b> Water droplets do not damage the product.</p> | <p>Try moving the product to a less humid area. Try a different media.</p>   |



# Scan problems

## Solve scanned-image problems

| Problem                               | Cause  | Solution   |
|---------------------------------------|--|--|
| The scanned image is of poor quality. | The original might be a second-generation photo or picture.  | <ul style="list-style-type: none"><li>• To eliminate the patterns, try reducing the size of the image after scanning.</li><li>• Print the scanned image to see if the quality is better.</li><li>• Verify that your resolution and color settings are correct for the type of scan job that you are performing.</li><li>• For best results, use the flatbed scanner for scanning, rather than the automatic document feeder (ADF).</li></ul> |
|                                       | The image that appears on the screen might not be an accurate representation of the quality of the scan. | <ul style="list-style-type: none"><li>• Try adjusting your computer monitor settings to use more colors (or levels of gray). Typically, you make this adjustment by opening <b>Display</b> in the Windows Control Panel.</li><li>• Try adjusting the resolution and color settings in the scanner software.</li></ul>  |
|                                       | The original might have been loaded incorrectly.   | Use the media guides when you load the originals into the ADF. See <a href="#">Load documents to fax, copy, or scan on page 26</a> .   |
|                                       | The scanner might be dirty.  | Clean the scanner. See <a href="#">Clean the product on page 49</a> .  |
|                                       | The graphics settings might not be suitable for the type of scan job that you are performing.            | Try changing the graphics settings.  |

| Problem                         | Cause  | Solution   |
|---------------------------------|--|--|
| Part of the image did not scan. | The original might have been loaded incorrectly.   | Use the media guides when you load the originals into the ADF. See <a href="#">Load documents to fax, copy, or scan on page 26</a> .   |
|                                 | A colored background might be causing images in the foreground to blend into the background. | Try adjusting the settings before you scan the original, or try enhancing the image after you scan the original.   |
|                                 | The original is longer than 381 mm (15 inches).  | The maximum scannable length is 381 mm (15 inches) when you use the automatic document feeder (ADF) input tray. If the page exceeds the maximum length, the scanner stops. (Copies can be longer.)<br><br><b>CAUTION:</b> Do not try to pull the original from the ADF; you might damage the scanner or your original. See <a href="#">Clear jams from the ADF on page 180</a> . |
|                                 | The original is too small.   | The minimum size that the flatbed scanner supports is 25 x 25 mm (1 x 1 inch). The minimum size that the ADF supports is 127 x 127 mm (5 x 5 inches). The original might be jammed. See <a href="#">Clear jams on page 179</a> .   |
|                                 | The media size is incorrect.   | In <b>Scan</b> settings, make sure that the input media size is large enough for the document that you are scanning.   |
| The scan takes too long.        | The resolution or color level is set too high.   | Change the resolution and color level settings to the correct settings for your job.   |
|                                 | The software is set to scan in color.  | The system default is color, which takes longer to scan even when scanning a monochrome original. If you acquire an image through TWAIN or WIA, you can change the settings so that the original scans in grayscale or black-and-white. See the product software Help for details.   |
|                                 | A print job or copy job was sent before you tried to scan.                                   | If someone sent a print job or copy job before you tried to scan, the scan will start if the scanner is not busy. However, because the product and scanner share memory, the scan might be slower.   |

## Scan-quality problems

### Prevent problems

The following are a few simple steps you can take to improve copy and scan quality.

- Use the flatbed scanner, rather than the automatic document feeder (ADF) input tray, to scan.
- Use high-quality originals.
- Load the media correctly. If the media is loaded incorrectly, it might skew, which causes unclear images. See [Load paper and print media on page 26](#) for instructions.
- Adjust the software settings according to how you plan to use the scanned page.
- If your product frequently feeds more than one page at a time, you might need to replace the separation pad. See [Replace the tray 2 and optional tray 3 separation pad on page 45](#).
- Use or make a carrier sheet to protect your originals.

### Solve scan-quality problems

| Problem                | Description  | Solution  |
|------------------------|--|---|
| Blank pages.           | The original might have been loaded upside down.                             | In the automatic document feeder (ADF), put the top end of the stack of originals into the ADF input tray, with the media stack face-up and the first page to be scanned on top of the stack.<br><br>On the flatbed scanner, place the original document face-down with the upper-left corner of the document at the lower-right corner of the glass. |
| Too light or dark.     | The resolution and color levels might be set incorrectly.                    | Verify that you have the correct resolution and color settings.   |
| Unwanted lines.        | Ink, glue, correction fluid, or an unwanted substance might be on the glass. | Clean the flatbed scanner surface. See <a href="#">Clean the flatbed scanner glass on page 49</a> .   |
|                        | The ADF glass might be dirty.  | Clean the ADF glass. See <a href="#">Clean the scanner-cover backing on page 51</a> .   |
| Black dots or streaks. | Ink, glue, correction fluid, or an unwanted substance might be on the glass. | Clean the flatbed scanner surface. See <a href="#">Clean the flatbed scanner glass on page 49</a> .   |
| Unclear text.          | The resolution and color levels may be set incorrectly.                      | Verify that you have the correct resolution and color settings.   |

# Copy problems

## Prevent problems

The following are a few simple steps you can take to improve copy quality:

- Copy from the flatbed scanner. This will produce a higher quality copy than copying from the automatic document feeder (ADF).
- Use quality originals.
- Load the media correctly. If the media is loaded incorrectly, it might skew, causing unclear images and problems with the OCR program.
- Use or make a carrier sheet to protect your originals.

 **NOTE:** Verify that the media meets HP specifications. If the media meets HP specifications, recurring feed problems indicate the pickup roller or separation pad is worn.

## Image problems

| Problem   | Cause   | Solution  |
|---|---|---|
| Images are missing or faded.                        | The print-cartridge toner level might be low. | Replace the print cartridge. See <a href="#">Remove the print cartridge on page 99</a> .  |
|   | The original might be of poor quality.        | If your original is too light or damaged, the copy might not be able to compensate, even if you adjust the contrast. If possible, find an original document in better condition.                                |
|   | The original might have a colored background. | Colored backgrounds might cause images in the foreground to blend into the background, or the background might appear in a different shade. If possible, use an original document without a colored background. |
| Vertical white or faded stripes appear on the copy. | The media might not meet HP specifications.   | Use media that meets HP specifications.   |
|   | The print-cartridge toner level might be low. | Replace the print cartridge. See <a href="#">Remove the print cartridge on page 99</a> .  |

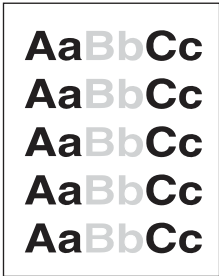

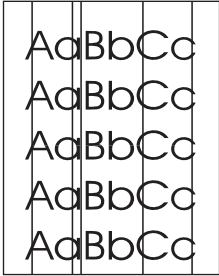
| Problem   | Cause   | Solution   |
|---|---|--|
| Unwanted lines appear on the copy.  | Tray 2 might not be installed correctly.                                      | Verify that the tray is in place.  |
|  | The flatbed scanner or the ADF glass might be dirty.                          | Clean the flatbed scanner or the ADF glass. See <a href="#">Clean the product on page 49</a> .                                       |
|   | The photosensitive drum inside the print cartridge might have been scratched. | Install a new HP print cartridge. See <a href="#">Remove the print cartridge on page 99</a> .  |
|   | Black dots or streaks appear on the copy.                                     | Ink, glue, correction fluid, or an unwanted substance might be on the automatic document feeder (ADF) or flatbed scanner.            |
| Copies are too light or dark.   | The printer driver or product software settings might be incorrect.           | Verify that the quality settings are correct.<br><br>See the product software Help for more information about changing the settings. |
| Text is unclear.  | The printer driver or product software settings might be incorrect.           | Verify that the quality settings are correct.<br><br>See the product software Help for more information about changing the settings. |

## Media-handling problems

| Problem                               | Cause   | Solution   |
|---------------------------------------|---|--|
| Poor print quality or toner adhesion. | The paper is too moist, too rough, too heavy or too smooth, or it is embossed or from a faulty paper lot. | Try another kind of paper, between 100 and 250 Sheffield, 4% to 6% moisture content. |
| Dropouts, jamming, or curl.           | The paper has been stored incorrectly.  | Store paper flat in its moisture-proof wrapping.                                     |
|                                       | The paper has variability from one side to the other.   | Turn the paper over.   |
| Excessive curl.                       | The paper is too moist, has the wrong grain direction, or is of short-grain construction                  | Open the rear output bin, or use long-grain paper.                                   |
|                                       | The paper varies from one side to the other.  | Turn the stack over.   |
| Jamming, damage to product            | The paper has cutouts or perforations.  | Use paper that is free of cutouts or perforations.                                   |

| Problem  | Cause  | Solution  |
|--|--|---|
| Problems with feeding.                                     | The paper has ragged edges.  | Use high-quality paper that is made for laser printers.   |
|  | The paper varies from side-to-side.  | Turn the paper over.  |
|  | The paper is too moist, too rough, too heavy or too smooth, has the wrong grain direction, or is of short-grain construction or it is embossed or from a faulty paper lot. | Try another kind of paper, between 100 and 250 Sheffield, 4% to 6% moisture content.<br><br>Open the rear output bin, or use long-grain paper.  |
| Print is skewed (crooked).                                 | The media guides might be incorrectly adjusted.  | Remove all media from the input tray, straighten the stack, and then load the media in the input tray again. Adjust the media guides to the width and length of the media that you are using and try printing again.                              |
| More than one sheet feeds at one time.                     | The media tray might be overloaded.  | Remove some of the media from the tray.   |
|  | The media might be wrinkled, folded, or damaged.   | Verify that the media is not wrinkled, folded, or damaged. Try printing on media from a new or different package.   |
| The product does not pull media from the media input tray. | The product might be in manual feed mode.  | <ul style="list-style-type: none"> <li>● If <b>Manual feed</b> appears on the product control-panel display, press <b>OK</b> to print the job.</li> <li>● Verify that the product is not in manual feed mode and print your job again.</li> </ul> |
|  | The pickup roller might be dirty or damaged.   | Replace the pickup roller. See <a href="#">Replace the tray 2 pickup roller on page 40</a> .  |
|  | The paper-length adjustment control in tray 2 or optional tray 3 is set at a length that is greater than the media size.   | Adjust the paper-length adjustment control to the correct length.   |



## Performance problems

| Problem                        | Cause   | Solution   |
|--------------------------------|---|--|
| No copy came out.              | The input tray might be empty.  | Load media in the product. See <a href="#">Load paper and print media on page 26</a> for more information.   |
|                                | The original might have been loaded incorrectly.                        | In the automatic document feeder (ADF), load the original with the narrow side forward and the side to be scanned facing up.<br><br>On the flatbed scanner, place the original document face-down with the upper-left corner of the document at the lower-right corner of the glass. |
| Copies are blank.              | The sealing tape might not have been removed from the print cartridge.  | Remove the print cartridge from the product, pull out the sealing tape, and then reinstall the print cartridge.  |
|                                | The original might have been loaded incorrectly.                        | In the ADF, load the original with the narrow side forward and the side to be scanned facing up.<br><br>On the flatbed scanner, make sure that the original document is placed face-down with the upper-left corner of the document at the lower-right corner of the glass.          |
|                                | The media might not meet HP specifications.                             | Use media that meets HP specifications.  |
|                                | The print-cartridge toner level might be low.                           | Replace the print cartridge. See <a href="#">Remove the print cartridge on page 99</a> .   |
| The wrong original was copied. | The ADF might be loaded.  | Make sure that the ADF is empty.   |
| Copies are reduced in size.    | The product software settings might be set to reduce the scanned image. | See the HP ToolboxFX Help for more information about changing the settings.  |

# Fax problems

## General fax problem-solve

Verify the following information before problem-solving fax problems.

- Is the fax set up correctly?
  - Make sure that the fax cord that came with the product is the cord that is being used. This cord has been tested and meets the device specifications.
  - Make sure that the fax cord is installed in the correct port. The fax cord (from the wall receptacle) must be plugged into the *line* port (  ).
  - Additional devices connected to the product must use the telephone port (  )
- What type of telephone line is being used?
  - **Dedicated telephone line:** a unique telephone line that is assigned to receive or send a fax. The fax cord must be plugged into the *line* port.
  - **Shared telephone line:** a telephone line that receives or sends voice calls and faxes. A single, shared telephone line can perform only one function at a time. A fax cannot be sent while someone is talking on the telephone or while a computer is connecting to the Internet.
  - **Roll-over lines:** a telephone system feature that allows an incoming call to be forwarded to the next available telephone line (used with multiple-telephone-line systems). Try attaching the device to the first incoming telephone line. The product will answer the telephone after it rings the number of times that is specified in the product rings-to-answer setting.
  - **Downstream phone:** a phone that is plugged directly into the phone connector on the product.
  - **Extension phone:** a phone that uses the same phone line as the product, but is connected to a separate phone wall receptacle.
  - **Distinctive ring service:** a telephone system feature that can assign two telephone numbers to one physical line, and assign a distinctive ring pattern to each number. Make sure that the device is set to respond to the correct distinctive ring pattern that the telephone service provider assigned to the fax number. This service is not available in all countries/regions. Make sure that the telephone company provides this service before changing the setting. For more information about distinctive ring service, see [Distinctive ring function on page 88](#).
- Is a telephone-line splitting device installed?
  - A telephone-line splitter is a device that splits two or more telephone lines from the same jack. Not all splitters are compatible with the device, and not all countries/regions support the use of splitters.

Parallel splitters (also called T-splitters) split a single line into two phone jacks so that two devices can share the same line. Line 1/Line 2 splitters provide two unique telephone line outlets from a single jack with two unique telephone numbers (two telephone lines are connected to a single jack). A Line 1/Line 2 splitter *must* be used if both a fax line and a voice line share the same jack.



 **NOTE:** Hewlett-Packard does not recommend using a parallel splitter (T-splitter) with the product because it might degrade the quality of the telephone signal. If a second device must be attached to the telephone line in addition to the product, plug the second device into the telephone port on the product (the port on the back that is marked with a telephone icon).

- Is a surge-protection device installed?
  - A surge-protection device might be installed between the telephone jack and the product to protect the product from electrical power that passes through the telephone lines. These devices might cause some fax communication problems by degrading the quality of the telephone signal. If you are having problems sending or receiving faxes, connect the device directly to the telephone jack to determine if the problem is in the surge-protection device.
- Is a telephone company voice-message service being used?
  - If the messaging service rings-to-answer setting is lower than the product rings-to-answer setting, the messaging service answers the call and the product will not detect incoming faxes. If the product rings-to-answer setting is lower than that of the messaging service, the product answers all calls and no calls will ever be sent to the messaging service. The only voice-messaging system that can be used with the product is a standard telephone-answering machine.
- Is a standard telephone-answering machine installed?
  - An answering machine must be connected to the port that is labeled with the telephone icon (or it can be shared on the same telephone-line extension). Set the product rings-to-answer setting for at least one ring more than the number of rings that prompts the answering machine to answer an incoming call. For example, if the answering machine is set to answer calls after three rings, set the product rings-to-answer setting to four rings.

 **NOTE:** If an answering machine is connected to the same telephone line, but is connected to a different jack (for example, in another room), it might interfere with the product fax reception.

## Problems receiving faxes

Use the table in this section to solve problems that might occur when receiving faxes.

 **NOTE:** You must use the fax cord that came with the product in order to ensure that the product functions correctly.

| Problem   | Cause   | Solution   |
|---|---|--|
| The product cannot receive faxes from an extension telephone. | The extension-telephone setting might be disabled.  | Verify that the extension-telephone setting is enabled.  |
|   | The fax cord might not be securely connected.   | Verify that the fax cord is securely connected between the telephone jack and the product (or another device that is connected to the product). Press 1-2-3 in sequence (tone-dial mode only), wait for three seconds, and then hang up. |
|   | The product dialing mode might be incorrectly set, or the extension phone might be incorrectly set. | Verify that the product dialing mode is set to <b>Tone</b> . Verify that the extension phone is set to <b>On</b> for tone dialing as well.   |

| Problem  | Cause   | Solution   |
|--|---|--|
| The product is not answering incoming fax calls. | The answer mode might be set to <b>Manual</b> .   | If the answer mode is set to <b>Manual</b> , the product does not answer calls. You have to start the fax-receiving process manually.  |
|  | The rings-to-answer setting might not be set correctly.   | Check the rings-to-answer setting for your configuration.  |
|  | The answer-ring pattern feature might be turned on, but you do not have the service, or you do have the service and the feature is not set correctly. | Check the answer-ring pattern feature to verify that it is set properly.   |
|  | The fax cord might not be correctly connected, or the fax cord is not working.  | See the Getting Started Guide to check the installation. Verify that you are using the fax cord that came with the product.  |
|  | The product might not be able to detect incoming fax tones because the answering machine is playing a voice message.                                  | Re-record your answering machine message, leaving at least two seconds of silence at the beginning of the message.   |
|  | Too many devices might be connected to the telephone line.  | You should not have more than three devices attached to the line. Try removing the last device that was connected and determine whether the product works. If not, continue removing devices one at a time and retry after removing each one.  |
|  | The telephone line might not be working.  | Do one of the following: <ul style="list-style-type: none"> <li>● Increase the volume on the product, and then press <b>Start Fax</b> on the control panel. If you hear a dial tone, the telephone line is working.</li> <li>● Disconnect the product from the telephone jack, and then connect a telephone. Try to make a telephone call to verify that the telephone line is working.</li> </ul> |

| Problem  | Cause   | Solution   |
|--|---|--|
| The product is not answering incoming fax calls.                       | A voice-messaging service might be interfering with the product as it attempts to answer calls. | Do one of the following: <ul style="list-style-type: none"> <li>• Disable the messaging service.</li> <li>• Get a telephone line that is dedicated to fax calls.</li> <li>• Set the product answer mode to <b>Manual</b>. In manual mode, you must start the fax-receive process yourself.</li> <li>• Leave the product set to automatic mode and lower the rings-to-answer setting for the product to a number less than the rings-to-answer setting for the voice mail. The product will answer all incoming calls.</li> </ul> |
|  | The product might be out of paper and the memory is full.                                       | Refill the media input tray. Press <b>OK</b> . The product prints all of the faxes it has saved in memory and then resumes answering fax calls.  |
| Faxes are not printing.  | The media input tray is empty.  | Load media. Any faxes that are received while the input tray is empty are stored in memory and will print after the tray has been refilled.  |
|  | The receive-to-PC option might be selected, and faxes are being received by the computer.       | Check to determine whether the computer is receiving faxes.  |
| Faxes are printing on two pages instead of one.                        | The auto reduction setting might not be set correctly.  | Turn on the auto reduction setting.  |
|  | The incoming faxes might have been sent on larger media.  | Adjust the auto reduction setting to allow larger pages to be printed on one page.   |
| Received faxes are too light or are printing only on half of the page. | The product ran out of toner while printing a fax.  | The product stores the most recently printed faxes. (The amount of memory that is available determines the actual number of faxes stored for reprinting.) As soon as possible, replace the print cartridge, and then reprint the fax.  |
|  | The fax that was sent was too light.  | Contact the sender and have the sender resend the fax after altering the settings.   |

## Problems sending faxes

| Problem   | Cause  | Solution  |
|---|--|---|
| The document stops feeding in the middle of faxing.     | The maximum length of a page that you can load is 381 mm (15 inches). Faxing of a longer page stops at 381 mm (15 inches). | Print the document on shorter media.<br><br>If no jam exists and less than one minute has elapsed, wait a moment before pressing <b>Cancel</b> . If a jam exists, see <a href="#">Clear jams on page 179</a> . Then, resend the job.  |
|   | If the item is too small, it can jam inside the automatic document feeder (ADF).   | Use the flatbed scanner. The minimum page size for the ADF is 127 x 127 mm (5 x 5 inches).<br><br>If a jam exists, see <a href="#">Clear jams from the ADF on page 180</a> . Then, resend the job.  |
| Faxes stop during sending.                              | The fax machine to which you are sending might be malfunctioning.  | Try sending to another fax machine.   |
|   | Your telephone line might not be working.  | Do one of the following: <ul style="list-style-type: none"> <li>● Turn up the volume on the product, and then press <b>Start Fax</b> on the control panel. If you hear a dial tone, the telephone line is working.</li> <li>● Disconnect the product from the jack in the wall, and then connect a telephone to the jack. Try to make a telephone call to verify that the telephone line is working.</li> </ul> |
|   | A communication error might be interrupting the fax job.   | Change the redial-on-communication-error setting to <b>On</b> .   |
| The product is receiving faxes but is not sending them. | If your product is on a PBX system, the PBX system might be generating a digital tone that the product cannot detect.      | Disable the detect-dial-tone setting.   |
|   | A poor telephone connection might exist.   | Try again later.  |
|   | The fax machine to which you are sending might be malfunctioning.  | Try sending to another fax machine.   |
|   | Your telephone line might not be working.  | Do one of the following: <ul style="list-style-type: none"> <li>● Turn up the volume on the product and press <b>Start Fax</b> on the control panel. If you hear a dial tone, the telephone line is working.</li> <li>● Disconnect the product from the telephone jack and connect a telephone. Try to make a telephone call to verify that the telephone line is working.</li> </ul>                           |
| Outgoing fax calls continue to be dialed.               | The product automatically redials a fax number if the redial options are set to <b>On</b> .                                | To stop the redials while the product is dialing, press <b>Cancel</b> .   |

| Problem   | Cause  | Solution  |
|---|--|---|
| Faxes that you send are not arriving at the receiving fax machine.      | The receiving fax machine might be off or might have an error condition, such as being out of paper.   | Call the recipient to verify that the fax machine is on and ready to receive faxes.   |
|   | The originals might be incorrectly loaded.   | Verify that the original documents are correctly loaded into the ADF input tray or flatbed scanner. See <a href="#">Load paper and print media on page 26</a> .   |
|   | A fax might be in memory because it is waiting to redial a busy number, other jobs that are ahead of it are waiting to be sent, or the fax is set up for a delayed send. | If a fax job is in memory for any of these reasons, an entry for the job appears in the fax log. Print the fax activity log and check the <b>Status</b> column for jobs that show a <b>Pending</b> designation.   |
| Faxes you send include a block of gray shading at the end of each page. | You might be sending a fax from the flatbed scanner with the glass-fax size set incorrectly.   | Verify that the setting is correct.   |
| Faxes you send have data missing from the end of each page.             | You might be sending a fax from the flatbed scanner with the glass-fax size set incorrectly.   | Verify that the setting is correct.   |
| You receive a Low Memory error.   | You might be sending a fax that is too large, or the resolution might be too high.   | Try one of the following: <ul style="list-style-type: none"> <li>● Divide a large fax into smaller sections, and then fax them individually.</li> <li>● Clear stored faxes to make more memory available for outgoing faxes.</li> <li>● Configure the outgoing fax as a delayed fax, and then verify that it will send completely.</li> <li>● Make sure that you are using the lowest resolution setting (<b>Standard</b>).</li> <li>● Turn the product power off and then on.</li> </ul> |

## Voice-call problems

| Problem  | Cause   | Solution   |
|--|---|--|
| The telephone or answering machine that is connected to the line is not receiving voice calls. | The fax cord might not be correctly connected.                          | See the Getting Started Guide to check the installation. The product must be the first device connected to the telephone line. |
|  | The answer mode or rings-to-answer settings might not be correctly set. | The rings-to-answer must be set higher than the answering machine setting.   |
|  | The answering machine or telephone might not be functioning.            | Connect the telephone or answering machine directly to the telephone line and determine if it works by itself.                 |
|  | The problem persists.   | See the Fax chapter in the product user guide.   |

## Media-handling problems

 **NOTE:** For information about removing jams, see [Clear jams on page 179](#).

| Problem                       | Cause  | Solution   |
|-------------------------------|--|--|
| Print is skewed (crooked).    | The media input tray might be overloaded.                      | Remove some of the media from the input tray.  |
|                               | The media guides might be incorrectly set, broken, or missing. | Verify that the guides are not adjusted too tightly or too loosely against the paper. Check for broken or missing guides, and replace them if necessary. |
|                               | The media might not meet HP specifications.                    | Use media that meets HP specifications.  |
| Pages are curled or wrinkled. | The media might not meet HP specifications.                    | Use media that meets HP specifications.  |
|                               | The paper path might be affecting the pages.                   | Open the rear output door on the back of the product and use this paper path.  |
|                               | The media is not stored properly.                              | When possible, store media in its sealed ream at room temperature.   |
|                               | The media has been in the input tray too long.                 | Turn over the stack of media in the tray or rotate the media 180° in the paper tray.   |

## Performance problems

| Problem  | Cause   | Solution   |
|--|---|--|
| Faxes are transmitting or being received very slowly.                          | The fax might be very complex, such as one with many graphics.                    | Complex faxes take longer to be sent or received. Breaking longer faxes into multiple jobs can increase the transmission speed.  |
|  | The receiving fax machine might have a slow modem speed.                          | The product only sends the fax at the fastest modem speed that the receiving fax machine can accept.   |
|  | The resolution at which the fax was sent or is being received might be very high. | If you are receiving the fax, call and ask the sender to lower the resolution and resend the fax. If you are sending the fax, lower the resolution and resend the fax. |
|  | Your telephone line might not be working.   | Hang up and resend the fax. Have the telephone company check the telephone line.   |
|  | You are sending a fax via an international call.                                  | You must allow more time to transmit fax jobs internationally.   |
| The fax activity logs or fax call reports are printing at inappropriate times. | The fax activity log or fax call reports settings are not correct.                | Print a Configuration page and check when the reports print.   |
| The product sounds are too loud or too soft.                                   | The volume setting might not be adjusted correctly.                               | Adjust the volume setting.   |



## Control-panel display problems

**CAUTION:** Static electricity can cause unexpected black lines or dots to appear on the product control-panel display. Do not touch the product control-panel display if there is a chance that you have collected a static electric charge (for example, by walking on carpet in a low-humidity environment).

Unexpected lines or dots might appear on the product control-panel display, or the display might become blank if the product is exposed to an electric or magnetic field. To resolve this problem, perform the following procedure:

1. Turn the product off.
2. Remove the product from the electric or magnetic field.
3. Turn the product on again.

 **NOTE:** If the product uses the Asian character display PCA and the formatter was recently replaced, make sure that the PCA is installed correctly and fully seated in the formatter connector (H3).

## Convenience-stapler problems (HP LaserJet M2727nfs only)

The convenience stapler is designed to be free of staple jams. To reduce the risk of staple jams, make sure that you staple 20 or fewer pages of media (80 g/m<sup>2</sup> or 20 lb) at a time.

**The convenience stapler does not staple pages.**

| Cause  | Solution  |
|--|---|
| The convenience-stapler door is not completely closed. | Make sure that the convenience-stapler door is completely closed.   |
| The convenience stapler has a staple jam.              | Clear the staple jam. See <a href="#">Clear jams from the convenience stapler (HP LaserJet M2727nfs MFP only) on page 189</a> . |

## DSL problems

A digital subscriber line (DSL) uses digital technology over standard copper phone wires. These DSL services rely on an AM signal. The product is a Group 3 fax device, which operates below the DSL capability and is not directly compatible with digital signals. However, if the configuration is specified during the DSL line setup, the signal on a DSL line can be separated so that some of the bandwidth is used to transmit an analog signal (for voice and fax), while the remaining bandwidth transmits digital data. Split the signal to use both the telephone or fax and the computer on the same line and at the same time.

---

 **NOTE:** Not all printers and faxes are compatible with DSL services. HP does not guarantee that the HP LaserJet product will be compatible with all DSL service lines or providers.

---

The DSL modem requires a high-pass filter. When DSL service is installed, the service provider sometimes supplies a splitter, which includes a low-pass filter, for the normal phone wiring. If not, the user should contact the DSL provider to request a filter or splitter so that a fax modem can operate on the line.

---

 **NOTE:** HP recommends discussing the DSL-line setup options with the DSL service provider. Consult the DSL provider for technical installation requirements.

---

An Asymmetric Digital Subscriber Line (ADSL) is a version of DSL that provides greater efficiency by allowing upload and download rates to differ. Because ADSL is a version of DSL, the previous DSL information also applies to ADSL.

## PABX line problems

The HP LaserJet product is an analog device that is not compatible with all digital phone environments (unless a digital-to-analog converter is used). It might be difficult for you to problem solve fax issues without assistance from someone who is familiar with the technical details of the customer's digital environment and the analog converter. HP does not guarantee that the HP LaserJet product will be compatible with digital environments or digital-to-analog converters.

# ADF problems

The “Document loaded” message continually appears on the control-panel display.

| Cause                                 | Solution  |
|---------------------------------------|---|
| The ADF paper-sensor flag is damaged. | Replace the ADF. See <a href="#">ADF assembly on page 115</a> . |

The “Scanner error” message continually appears on the control-panel display.

| Cause  | Solution   |
|--|--|
| The ADF-to-scanner connector is not connected correctly or the ADF is not functioning. | Reseat the connector. If the problem persists, replace the ADF. See <a href="#">ADF assembly on page 115</a> . |

The ADF pickup roller does not move.

| Cause  | Solution   |
|--|--|
| The ADF-to-scanner connector is not connected correctly or the ADF is not functioning. | Reseat the connector. If the problem persists, replace the ADF. See <a href="#">ADF assembly on page 115</a> . |

The ADF makes grinding, squeaking, or rubbing noises when a sheet feeds from the ADF input tray.

| Cause  | Solution   |
|--|--|
| The wrong ADF pickup-roller assembly is installed. | Make sure that the correct roller assembly is installed. If the problem persists, replace the ADF pickup-roller assembly. See <a href="#">Replace the ADF pickup-roller assembly on page 110</a> . |

The sheet begins to feed from the ADF input tray, but does not completely move through the ADF. The sheet *can* be pushed through the ADF by hand.

| Cause   | Solution   |
|---|--|
| The cleanout comb is not installed or is incorrectly installed.   | Make sure that the cleanout comb is installed correctly.   |
| The ADF pickup rollers are dirty.                                 | Clean the rollers. See <a href="#">Clean the ADF pickup-roller assembly on page 55</a> .                         |
| The media is curled or was stored in a high-humidity environment. | Use media that meets HP recommendations. See the user guide for media specifications.                            |
| The ADF pickup-roller assembly is damaged or is not functioning.  | Replace the ADF pickup-roller assembly. See <a href="#">Replace the ADF pickup-roller assembly on page 110</a> . |

The sheet begins to feed from the ADF input tray, but does not move through the ADF completely. The sheet *cannot* be pushed through the ADF by hand.

| Cause  | Solution   |
|--|--|
| The ADF pickup-roller assembly is damaged or is not functioning. | Replace the ADF pickup-roller assembly. See <a href="#">Replace the ADF pickup-roller assembly on page 110</a> . |

# Functional checks

## Drum rotation test

The photosensitive drum, located in the print cartridge, must rotate in order for the print process to work. The photosensitive drum receives its drive from the main-drive assembly.

---

 **NOTE:** This test is especially important if refilled print cartridges have been used.

---

1. Open the print-cartridge door.
2. Remove the print cartridge.
3. Mark the drive gear on the cartridge with a felt-tipped marker. Note the position of the mark.
4. Install the print cartridge and close the print-cartridge door. The startup sequence should rotate the drum enough to move the mark.
5. Open the print-cartridge door and inspect the gear that was marked in step 3. Verify that the mark moved.

If the mark did not move, inspect the main-drive assembly to make sure that it is meshing with the print cartridge gears. If the drive gears appear functional and the drum does not move, replace the print cartridge.

## Engine test

The engine test is used to verify that the print engine is functioning correctly. The formatter is bypassed during the engine test.

### To perform an engine test

1. Remove the left cover. See [Left cover on page 102](#).
2. Use a *non-conductive* probe to depress the engine-test switch. A single test page prints.

△ **CAUTION:** Use a non-conductive probe to depress the engine test switch. Inserting a conductive probe to depress the switch can damage the product.

📝 **NOTE:** The formatter must be connected to the ECU in order to perform an engine test. Otherwise, the product does not print.

**Figure 6-1** Engine test switch

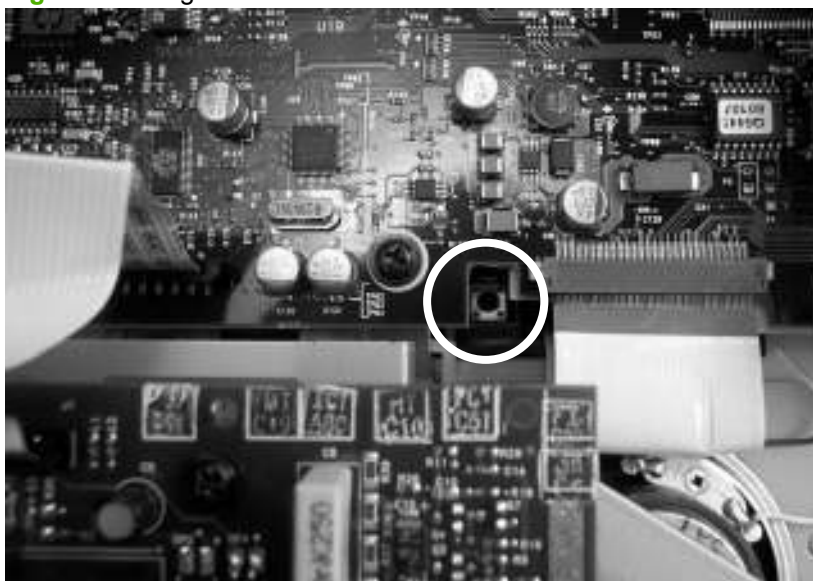

## Half self-test functional check

The print process can be subdivided into the following stages:

- Image formation stage (charges the drum and writes a latent image to the drum with the laser)
- Development stage (forms a toner image on the drum)
- Transfer stage (transfers the image to the media)
- Cleaning stage (removes excess toner from the drum)
- Fusing stage (applies heat and pressure to the media to make the image permanent)

## Perform a half self-test check

The purpose of the half self-test check is to determine which process is malfunctioning.

1. Print a configuration page.
2. Open the print-cartridge access door after the paper advances halfway through the product (approximately five seconds after the motor begins rotating). The leading edge of the paper should have advanced past the print cartridge.
3. Remove the print cartridge.
4. Open the print-cartridge drum shield to view the drum surface. If a dark and distinct toner image is present on the drum surface, assume that the first two functions of the electrophotographic process are functioning (image formation and development). Problem solve the failure as a transfer or fusing problem.

## Perform other checks

If no image appears on the photosensitive drum, perform these checks:

1. Make sure that you removed the entire length of the sealing tape from the print cartridge before you installed the cartridge.
2. Perform a drum-rotation functional check to ensure that the drum is rotating (see [Drum rotation test on page 230](#)).
3. Perform a high-voltage power-supply check. See [Heating element check on page 233](#).

## Heating element check

Media passes between the heating element and a soft pressure roller to fuse toner to the media.

1. Unplug the product for at least ten minutes.
2. Verify that the thermistor connector is seated into both the product chassis and the ECU.
3. Remove the heating element connector from the ECU. To measure the continuity of the heating element, measure the resistance between the two pins at the end of the cable.

---

 **NOTE:** Normal resistance is 25 ohms +/- 10 ohms for the 110 V product and 80 ohms +/- 20 ohms for the 220 V product.

---

If no resistance is measured, replace the fuser.

4. Remove the thermistor connector, and then measure the resistance between J206 pins one and two and between J206 pins three and four.

---

 **NOTE:** Normal resistance between both pairs of pins is 370K ohms +/- 50K ohms at 20°C (68° F).

---

5. If no resistance is measured, replace the fuser.

## High-voltage contacts check

The high-voltage contacts in the product must have a good connection with the contacts on the print cartridge to provide the necessary voltages for the electrophotographic processes.

### Check the print-cartridge contacts

Remove the print cartridge and visually inspect the three connection points on the ends of the print cartridge: drum ground (callout 1), charging (callout 2), and developing roller (callout 3). If they are dirty or corroded, clean the connection. If they are damaged, replace the print cartridge.

---

 **NOTE:** Use only isopropyl alcohol to clean the connections.

---

**Figure 6-2** Print-cartridge high-voltage connection points (right side)

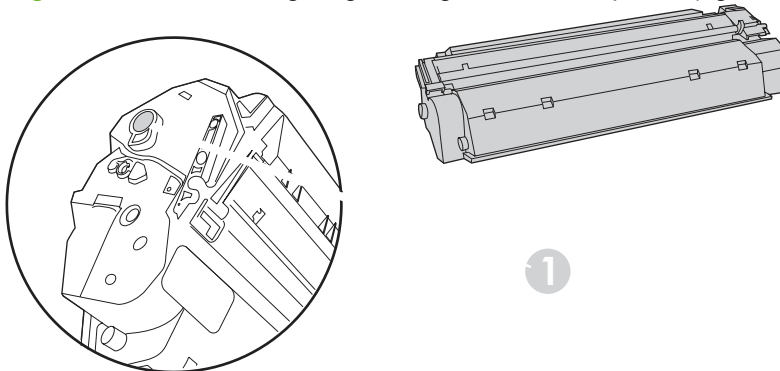

**Figure 6-3** Print-cartridge high-voltage connection points (left side)

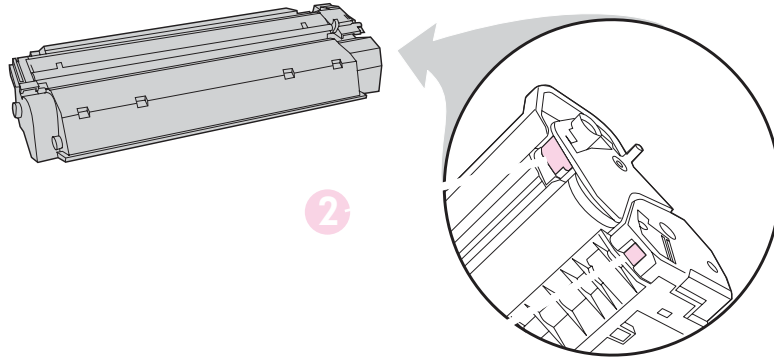

### **Check the high-voltage connector assembly**

Visually inspect the cartridge connection points inside the product to make sure that they are not dirty or corroded. If the pins are dirty, clean them by using isopropyl alcohol only.



# Service-mode functions

## NVRAM initialization

An NVRAM initialization will return the following device settings to the factory-set defaults:

- All menu settings, including the fax header and company name
- Fax numbers and names that are associated with one-touch keys and speed-dial codes

Additionally, all faxes stored in memory are cleared.

### Perform an NVRAM initialization

1. Turn off the product.
2. Simultaneously press and hold the **Cancel** button and the right arrow button (> ), and then turn on the product.
3. Wait until the message **Permanent storage init.** appears, and then release the **Cancel** and right arrow buttons.

When the NVRAM initialization process has been completed, the device control panel shows the **Ready** message.

## Super NVRAM initialization

A Super NVRAM initialization will return *all* of the device settings to the factory-set defaults (generic product mode).

---

 **NOTE:** When the product is turned on, you will be prompted to select the language and country/region setting before the product will initialize.

---

1. Turn off the product.
2. Simultaneously press and hold the **Cancel** button and the left arrow button (< ), and then turn on the product.
3. Wait until the message **Permanent storage init.** appears, and then release the **Cancel** and left arrow buttons.

## Service menu

---

 **NOTE:** An asterisk (\*) symbol next to a service submenu option indicates that this is the current setting for that option.

---

For more information about using the service menu, see [Service menu on page 241](#).

### Access the service menu

1. Press the **Setup** button.
2. Use the arrow buttons to select **Main Menu Service**, and then press **OK**.
3. Use the arrow buttons to select the desired secondary-service option, and then press the **OK** button.
4. Use the arrow buttons to select the desired submenu option, and then press **OK**.

| Service menu item       | Submenu option         | Description  |
|-------------------------|------------------------|--|
| <b>Print T.30 trace</b> | <b>At end of call*</b> | Use a T.30 trace report to problem solve fax transmission and receive errors.  |
|                         | <b>Never</b>           |  |
|                         | <b>Now</b>             |  |
|                         | <b>If error</b>        |  |
| <b>Archive print</b>    | <b>Off*</b>            | The archive print feature produces output that is less susceptible to toner smearing and dusting. Use archive print to create documents that you want to preserve or archive.  |
|                         | <b>On</b>              |  |
| <b>Less paper curl</b>  | <b>Off*</b>            | Lowers the fuser temperature.  |
|                         | <b>On</b>              |  |
| <b>Cleaning mode</b>    | None                   | Press <b>OK</b> to start the cleaning process. See <a href="#">Clean the paper path on page 56</a> for more information.   |
| <b>Restore defaults</b> | None                   | <p><b>CAUTION:</b> This procedure clears fax numbers and names that are associated with one-touch keys and speed-dial codes, and deletes any pages that are stored in the memory. The procedure then automatically restarts the product.</p> <p>Press <b>OK</b> to restore the product factory settings.</p> |

# Problem-solve tools

## Product information pages and reports

Information pages and reports reside within the product memory. These pages and reports help diagnose and solve problems with the product.

---

 **NOTE:** If the product language was not correctly set during installation, you can set the language manually so the information pages print in one of the supported languages. Change the language by using the **System setup** menu on the control panel or by using the embedded Web server.

---

### Configuration page

The Configuration page shows the current settings and product properties. Print a Configuration page from the product or HP ToolboxFX. To print from the product, complete the following steps:

1. On the product control panel, press **Setup**.
2. Use the arrow buttons to select **Reports**, and then press **OK**.
3. Use the arrow buttons to select **Config report**, and then press **OK**.

A second page also prints. On that page, the **Fax Settings** section provides details about the product fax settings.

### Supplies Status page

The Supplies Status page shows the remaining life of the HP print cartridge, the estimated pages remaining, the number of pages printed, and other supplies information. Print a Supplies Status page from the product or HP ToolboxFX. To print from the product, complete the following steps:

1. On the product control panel, press **Setup**.
2. Use the arrow buttons to select **Reports**, and then press **OK**.
3. Use the arrow buttons to select **Supplies Status**, and then press **OK**.

### PCL, PCL 6, or PS font list

The PCL, PCL 6, or PS font list shows which fonts are currently installed in the product. To print the PCL, PCL 6, or PS font list, complete the following steps:

1. On the product control panel, press **Setup**.
2. Use the arrow buttons to select **Reports**, and then press **OK**.
3. Use the arrow buttons to select **PCL font list**, **PS font list**, or **PCL 6 font list**, and then press **OK**.

## Demo page

The Demo page contains examples of text and graphics. To print the Demo page, complete the following steps:

1. On the product control panel, press **Setup**.
2. Use the arrow buttons to select **Reports**, and then press **OK**.
3. Use the arrow buttons to select **Demo page**, and then press **OK**.

## Usage page

The Usage page shows a page count for each size of paper printed, the number of one-sided (simplex) or two-sided (duplexed) pages, and the average percentage of coverage. To print the Usage page, complete the following steps:

1. On the product control panel, press **Setup**.
2. Use the arrow buttons to select **Reports**, and then press **OK**.
3. Use the arrow buttons to select **Usage page**, and then press **OK**.

## Menu map

The Menu map shows the control-panel menus and available settings. To print the Menu map, complete the following steps:

1. On the product control panel, press **Setup**.
2. Use the arrow buttons to select **Reports**, and then press **OK**.
3. Use the arrow buttons to select **Menu structure**, and then press **OK**.

## Network report

The Menu map shows the product network settings. To print the Network report, complete the following steps:

1. On the product control panel, press **Setup**.
2. Use the arrow buttons to select **Reports**, and then press **OK**.
3. Use the arrow buttons to select **Network report**, and then press **OK**.

## Fax reports

This section describes the fax reports that help you diagnose and solve problems with the product.

### Fax activity log

The fax activity log provides a chronological history of the last 40 faxes that were received, sent, or deleted, and any errors that occurred.

#### To print the fax activity log

1. On the product control panel, press **Setup**.
2. Use the arrow buttons to select **Reports**, and then press **OK**.
3. Use the arrow buttons to select **Fax Activity log**, and then press **OK**.
4. Press **OK** to select **Print log now**. The product exits the menu settings and prints the log.

### Fax call report

A fax call report is a brief report that indicates the status of the last fax that was sent or received.

#### To print a fax call report

1. On the product control panel, press **Setup**.
2. Use the arrow buttons to select **Reports**, and then press **OK**.
3. Use the arrow buttons to select **Fax Call report**, and then press **OK**.
4. Press **OK** to select **Print report now**. The product exits the menu settings and prints the report.

### Phone book report

A phone book report lists the fax numbers that are assigned to the one-touch buttons and speed-dial and group-dial entries.

#### To print a phone book report

1. On the product control panel, press **Setup**.
2. Use the arrow buttons to select **Reports**, and then press **OK**.
3. Use the arrow buttons to select **PhoneBook report**, and then press **OK**. The product exits the menu settings and prints the report.

## Billing-code report

The billing-code report is a printed list of all of the fax billing codes and the total number of faxes that have been billed to each code.

---

 **NOTE:** After this report is printed, all billing data is deleted.

---

### To print a billing-code report

1. On the product control panel, press **Setup**.
2. Use the arrow buttons to select **Reports**, and then press **OK**.
3. Use the arrow buttons to select **Billing report**, and then press **OK**. The product exits the menu settings and prints the report.

## HP ToolboxFX

HP ToolboxFX is a product configuration and problem solving tool.

### To view HP ToolboxFX

Open HP ToolboxFX in one of these ways:

- On the Windows desktop, double-click the HP ToolboxFX icon.
- On the Windows **Start** menu, click **Programs (All Programs in Windows XP)**, and then click **HP ToolboxFX**.

### Troubleshooting tab

HP ToolboxFX includes a **Troubleshooting** tab that contains links to the following main pages:

- **Control Panel Messages.** View descriptions of product control-panel messages.
- **Clearing Jams.** View information about locating and clearing jams.
- **Print Problems.** View Help topics that can help you solve print problems.
- **Scan Problems.** View Help topics that can help you solve scan problems.
- **Copy Problems.** View Help topics that can help you solve copy problems.
- **Fax Problems.** View Help topics that can help you solve fax problems.
- **Connectivity Problems.** View Help topics that can help you solve networking problems.
- **Troubleshooting Tools.** Employ such problem-solving tools as a cleaning page to maintain the product.
- **Animated Demonstrations.** View animated Help demonstrations for the product.

---

 **NOTE:** Other HP ToolboxFX tabs might be helpful in solving product problems.

---

## Service menu

Use the control-panel **Service** menu to solve product problems.

### Restore the factory-set defaults

Restoring the factory-set defaults returns all of the settings to the factory defaults, and it also clears the fax header name and phone number.

---

**CAUTION:** This procedure clears fax numbers and names that are associated with one-touch keys and speed-dial codes, and deletes any pages that are stored in the memory. The procedure then automatically restarts the product.

---

### Restore the factory-set defaults

1. On the product control panel, press **Setup**.
2. Use the arrow buttons to select **Service**, and then press **OK**.
3. Use the arrow buttons to select **Restore defaults**, and then press **OK**.

The product automatically restarts.

### Clean the paper path

The product features a special cleaning mode to clean the paper path.



---

**NOTE:** If you have access to HP ToolboxFX, HP recommends cleaning the paper path by using HP ToolboxFX.

---

### Clean the paper path

1. On the product control panel, press **Setup**.
2. Use the arrow buttons to select **Service**, and then press **OK**.
3. Use the arrow buttons to select **Cleaning Mode**, and then press **OK**.

A page feeds through the product slowly. Discard the page when the process is completed.

4. Load plain letter or A4 paper when you are prompted.
5. Press **OK** again to confirm and begin the cleaning process.

A page feeds through the product slowly. Discard the page when the process is completed.

## T.30 protocol trace

Use a T.30 protocol trace report to problem-solve fax transmission issues.

### Print a T.30 protocol trace report

Send a fax from the product or receive a fax to the product from another fax machine, and then print a T.30 trace report after the fax prints.

1. On the product control panel, press **Setup**.
2. Use the arrow buttons to select **Service**, and then press **OK**.
3. Use the arrow buttons to select **Print T.30**, and then press **OK**.

The product exits the menu settings and prints the reports.

## Archive print

Archive print produces output that is less susceptible to toner smearing and dusting. Use archive print to create documents that you want to preserve or archive.

### Turn on archive print

1. On the product control panel, press **Setup**.
2. Use the arrow buttons to select **Service**, and then press **OK**.
3. Use the arrow buttons to select **Archive print, On, or Off**, and then press **OK**.



## Firmware updates

The product has a flash-memory-based formatter that enables the firmware code to be updated in the event that new firmware is released for the product. Using flash memory also provides a way to recover the firmware in the event of code corruption or failure.

### Firmware update by using a flash executable file

The configuration page lists the firmware version of the product. On the flash-memory-based product, you can update the firmware code by downloading the latest flash executable file for the product and running the program according to the readme instructions that come with it (go to [www.hp.com](http://www.hp.com)). Turn the product off and then on before running the executable file. If the firmware becomes corrupted or fails (usually because of an interruption when attempting to update the firmware), the product no longer functions and will require the formatter be replaced.



---

# 7 Parts

- [Accessories and ordering information](#)
- [Supplies](#)
- [Memory](#)
- [Cable and interface accessories](#)
- [Paper-handling accessories](#)
- [Whole unit replacement](#)
- [Scanner/ADF replacement parts](#)
- [Control-panel bezels](#)
- [Supplementary documentation and support](#)
- [Problem-solve diagrams](#)
- [Parts lists and diagrams](#)
- [Scanner and ADF assemblies](#)
- [Scanner components](#)
- [ADF components](#)
- [Convenience stapler components \(HP LaserJet M2727nfs only\)](#)
- [Formatter, fax card, HP jewel, and nameplate](#)
- [External covers and panels](#)
- [Cartridge door assembly](#)
- [Internal components \(1 of 4\)](#)
- [Internal components \(2 of 4\)](#)
- [Internal components \(3 of 4\)](#)
- [Internal components \(4 of 4\)](#)
- [Engine-controller assembly \(ECU\)](#)
- [Main-drive assembly](#)
- [Duplexing-drive assembly](#)

- [Tray 2 cassette and tray 3 cassette/feeder](#)
- [Duplexing assembly](#)
- [Fuser assembly](#)
- [Alphabetical parts list](#)
- [Numerical parts list](#)

## Accessories and ordering information

Order replacement parts from the following Web sites:

- HP Parts Store: [www.partsdirect.hp.com](http://www.partsdirect.hp.com) or [www2.hp.com/hpparts/default.asp](http://www2.hp.com/hpparts/default.asp)

Order supplies from the following Web sites:

- To order supplies in the U.S., go to [www.hp.com/sbso/product/supplies](http://www.hp.com/sbso/product/supplies).
- To order supplies worldwide, go to [www.hp.com/ghp/buyonline.html](http://www.hp.com/ghp/buyonline.html).
- To order supplies in Canada, go to [www.hp.ca/catalog/supplies](http://www.hp.ca/catalog/supplies).
- To order supplies in Europe, go to [www.hp.com/go/ljsupplies](http://www.hp.com/go/ljsupplies).
- To order supplies in Asia-Pacific, go to [www.hp.com/paper/](http://www.hp.com/paper/).
- To order accessories, go to [www.hp.com/go/accessories](http://www.hp.com/go/accessories).

## Supplies

| Item                     | Description  | Part number                                |
|--------------------------|--|--|
| Black print cartridge    | Average yield for the standard print cartridge is approximately 3,500 pages. Average yield for the extended print cartridge is approximately 7,000 pages. Actual yield depends on use. | Standard: Q7553A (standard; new)           |
|                          |  | Q7553–67901 (standard; exchange)           |
|                          |  | Extended life: Q7553X (extended life; new) |
|                          |  | Q7553–67902 (extended life; exchange)      |
| Staple cassette (2 pack) | 1,500-staple capacity each   | Q7432A (retail)                            |
|                          |  | Q7432–67001 (service)                      |

## Memory

| Item                    | Description   | Part number |
|-------------------------|---|-------------|
| Memory upgrades (DIMMs) | The standard 64 MB of memory in the product can be expanded to up to 320 MB upgrading the DIMM. | CB421A      |
|                         | 64 MB   |             |
| Memory upgrades (DIMMs) | 128 MB  | CB422A      |
| Memory upgrades (DIMMs) | 256 MB  | CB423A      |

## Cable and interface accessories

| Item                             | Description  | Part number |
|----------------------------------|--|-------------|
| USB cable                        | 2-meter (6.56 feet) standard USB-compatible device connector | C6518A      |
|                                  | 3-meter (9.84 feet) standard USB-compatible device connector | C6520A      |
| HP Wireless Printing Upgrade Kit | Printing adapter for wireless point-to-point printing        | Q6259A      |
| Fax cord                         | Two-wire phone cord adapter                                  | 8121–0811   |
| Fax dongle                       | Two-wire to four-wire adapter (US)                           | Q3093–80004 |
| Power cord                       | 1.8 meter (6 feet) US/Canada                                 | 8120-8382   |
| Power cord                       | 1.8 meter (6 feet) Europe                                    | 8121-0516   |
| Power cord                       | 1.8 meter (6 feet) Switzerland                               | 8121-0519   |
| Power cord                       | 1.8 meter (6 feet) United Kingdom                            | 8121-0517   |
| Power cord                       | 1.8 meter (6 feet) Danish                                    | 8121-0518   |

| Item       | Description                      | Part number |
|------------|----------------------------------|-------------|
| Power cord | 1.8 meter (6 feet) South America | 8121-0520   |
| Power cord | 1.8 meter (6 feet) Israel        | 8121-1004   |

## Paper-handling accessories

| Item                            | Description  | Part number           |
|---------------------------------|--|-----------------------|
| Optional tray 3 cassette/feeder | 250-sheet input tray/feeder for standard sizes. Only one optional 250-sheet tray can be installed. | Q7556A (new)          |
|                                 |  | Q7556-67901 (service) |
| Tray 2 cassette                 | 250-sheet input tray for standard sizes  | RM1-4251-000CN        |
| Staple cassette (2 pack)        | 1,500-staple capacity each   | Q7432A (retail)       |
|                                 |  | Q7432-67001 (service) |

# Whole unit replacement

Use the tables in this section to find the whole unit replacement part number for a specific product bundle and localized configuration.

**Table 7-1 Whole unit replacement, product bundle CB532A**

| Country/region | Localized configuration                         | Replacement part number |
|----------------|---|-------------------------|
| Asia Pacific   | AB0 - Taiwan-Traditional Chinese                | CB532-67906             |
|                | AB1 - Korea-Korean localization                 | CB532-67907             |
|                | AB2 - China-Simplified Chinese                  | CB532-67908             |
|                | AB3 - Thailand-Thai                             | CB532-67909             |
|                | AB4 - Singapore-English                         | CB532-67910             |
|                | BFV - Hong Kong SAR-English/Traditional Chinese | CB532-67911             |
|                | ABG - Australia-English                         | CB532-67912             |
|                | A2K - Philippines-English                       | CB532-67913             |
|                | ACJ - India-English                             | CB532-67914             |
|                | AK3 - Indonesia - Indonesia localizaton         | CB532-67915             |
|                | AR7 - New Zealand-English                       | CB532-67916             |
|                | UUD - Vietnam-Vietnamese localization           | CB532-67917             |
|                | ARR - Asia Pacific (Euro Cord)-English          | CB532-67918             |
|                | ARS - Asia Pacific (UK Cord)-English            | CB532-67919             |



**Table 7-1 Whole unit replacement, product bundle CB532A (continued)**

| Country/region   | Localized configuration                                | Replacement part number |
|--|--|-------------------------|
| Europe, Middle East, and Africa                        | ABD - Germany-German                                   | CB532-67921             |
|  | ABF - France-French                                    | CB532-67922             |
|  | ABH - Netherlands-Dutch                                | CB532-67923             |
|  | ABZ - Italy-Italian                                    | CB532-67924             |
|  | ABE - Spain - Spanish localization                     | CB532-67925             |
|  | BFY - Spain-Catalan localization                       | CB532-67926             |
|  | ABU - United Kingdom-English                           | CB532-67927             |
|  | B14 - Belgium-Dutch/French                             | CB532-67928             |
|  | AR8 - Switzerland-French/German                        | CB532-67929             |
|  | BB1 - Norway/Finland/Sweden-NO/FI/SV localization      | CB532-67930             |
|  | ABY - Denmark-Danish                                   | CB532-67931             |
|  | ACB - Russia-Cyrillic                                  | CB532-67932             |
|  | BCM - Czech Rep/Slovakia - Czech/Slovak localization   | CB532-67933             |
|  | AKC - Hungary - Hungarian localization                 | CB532-67934             |
|  | AKD - Poland - Polish localization                     | CB532-67935             |
|  | AB9 - Portugal - Portuguese localization               | CB532-67936             |
|  | ACQ - South Africa-English                             | CB532-67937             |
|  | BCP - Greece/Israel - Greek/Hebrew localization        | CB532-67938             |
|  | BFQ - Mid East 220V-AR/FR/EN localization              | CB532-67939             |
|  | BFR - Estonia/Lithuania/Latvia-ET/LT/LV                | CB532-67940             |
|  | BFS - Slovenia/Croatia/Serbia-SL/HR/SR                 | CB532-67941             |
|  | BFZ - Kazakhstan/Ukraine-Kazakh/Ukrainian localization | CB532-67942             |
|  | AB8 - Turkey - Turkish localization                    | CB532-67943             |
| BG1 - Romania/Bulgaria-Romanian/Bulgarian localization | CB532-67944  |                         |
| Latin America  | AC8 - Argentina-Spanish                                | CB532-67945             |
|  | ABM - Latin Amer - (120v) Spanish localization         | CB532-67946             |
|  | AC4 - Brazil-Portuguese                                | CB532-67947             |
|  | AKV - South America-Spanish                            | CB532-67948             |
| North America  | ABA - U. S.-English                                    | CB532-67949             |
|  | A2L - Canada-FR/EN                                     | CB532-67951             |

**Table 7-2 Whole unit replacement, product bundle CB533A**

| <b>Country/region</b> | <b>Localized configuration</b>                  | <b>Replacement part number</b> |
|-----------------------|---|--------------------------------|
| Asia Pacific          | AB0 - Taiwan-Traditional Chinese                | CB533-67901                    |
|                       | AB1 - Korea-Korean localization                 | CB533-67902                    |
|                       | AB2 - China-Simplified Chinese                  | CB533-67903                    |
|                       | AB3 - Thailand-Thai                             | CB533-67904                    |
|                       | AB4 - Singapore-English                         | CB533-67905                    |
|                       | BFV - Hong Kong SAR-English/Traditional Chinese | CB533-67906                    |
|                       | ABG - Australia-English                         | CB533-67907                    |
|                       | A2K - Philippines-English                       | CB533-67908                    |
|                       | ACJ - India-English                             | CB533-67909                    |
|                       | AK3 - Indonesia - Indonesia localizaton         | CB533-67910                    |
|                       | AR7 - New Zealand-English                       | CB533-67911                    |
|                       | UUD - Vietnam-Vietnamese localization           | CB533-67912                    |
|                       | ARR - Asia Pacific (Euro Cord)-English          | CB533-67913                    |
|                       | ARS - Asia Pacific (UK Cord)-English            | CB533-67914                    |

**Table 7-2 Whole unit replacement, product bundle CB533A (continued)**

| Country/region   | Localized configuration                                | Replacement part number |
|--|--|-------------------------|
| Europe, Middle East, and Africa                        | ABD - Germany-German                                   | CB533-67916             |
|  | ABF - France-French                                    | CB533-67917             |
|  | ABH - Netherlands-Dutch                                | CB533-67918             |
|  | ABZ - Italy-Italian                                    | CB533-67919             |
|  | ABE - Spain - Spanish localization                     | CB533-67920             |
|  | BFY - Spain-Catalan localization                       | CB533-67921             |
|  | ABU - United Kingdom-English                           | CB533-67922             |
|  | B14 - Belgium-Dutch/French                             | CB533-67923             |
|  | AR8 - Switzerland-French/German                        | CB533-67924             |
|  | BB1 - Norway/Finland/Sweden-NO/FI/SV localization      | CB533-67925             |
|  | ABY - Denmark-Danish                                   | CB533-67926             |
|  | ACB - Russia-Cyrillic                                  | CB533-67927             |
|  | BCM - Czech Rep/Slovakia - Czech/Slovak localization   | CB533-67928             |
|  | AKC - Hungary - Hungarian localization                 | CB533-67929             |
|  | AKD - Poland - Polish localization                     | CB533-67930             |
|  | AB9 - Portugal - Portuguese localization               | CB533-67931             |
|  | ACQ - South Africa-English                             | CB533-67932             |
|  | BCP - Greece/Israel - Greek/Hebrew localization        | CB533-67933             |
|  | BFQ - Mid East 220V-AR/FR/EN localization              | CB533-67934             |
|  | BFR - Estonia/Lithuania/Latvia-ET/LT/LV                | CB533-67935             |
|  | BFS - Slovenia/Croatia/Serbia-SL/HR/SR                 | CB533-67936             |
|  | BFZ - Kazakhstan/Ukraine-Kazakh/Ukrainian localization | CB533-67937             |
|  | AB8 - Turkey - Turkish localization                    | CB533-67938             |
| BG1 - Romania/Bulgaria-Romanian/Bulgarian localization | CB533-67939  |                         |
| Latin America  | AC8 - Argentina-Spanish                                | CB533-67940             |
|  | ABM - Latin Amer - (120v) Spanish localization         | CB533-67941             |
|  | AC4 - Brazil-Portuguese                                | CB533-67942             |
|  | AKV - South America-Spanish                            | CB533-67943             |
| North America  | ABA - U. S.-English                                    | CB533-67944             |
|  | A2L - Canada-FR/EN                                     | CB533-67946             |

## Scanner/ADF replacement parts

| Item  | Part number |
|---|-------------|
| PKG FGI ASSY HP LaserJet M2727 SSA (scanner assembly) | CB532-67905 |
| PKG FGI ASSY HP LaserJet M2727 ADF (ADF assembly)     | CB532-67903 |
| HP LaserJet M2727 ADF cover replacement kit           | Q6500-67901 |
| ADF flag replacement kit                              | Q3948-67902 |
| HP LaserJet M2727 input tray assembly                 | Q6500-60119 |
| Clean out ADF   | C7309-40153 |
| ADF pick roller assembly                              | 5851-2559   |
| ADF separation pad                                    | Q2665-60125 |
| ADF assembly hinge replacement kit                    | Q3948-67905 |
| HP LaserJet M2727 ADF window replacement kit          | Q6500-67904 |

# Control-panel bezels

**Table 7-3 Control-panel bezels**

| Item                | Language                   | Part number |
|---------------------|----------------------------|-------------|
| Control-panel bezel | English (EN)               | CB532-40009 |
| Control-panel bezel | French (FR)                | CB532-40013 |
| Control-panel bezel | German (DE)                | CB532-40012 |
| Control-panel bezel | German (unpainted) (DE)    | CB532-40036 |
| Control-panel bezel | Italian (IT)               | CB532-40015 |
| Control-panel bezel | Spanish (ES)               | CB532-40010 |
| Control-panel bezel | Danish (DA)                | CB532-40019 |
| Control-panel bezel | Dutch (NL)                 | CB532-40014 |
| Control-panel bezel | Finnish (FI)               | CB532-40018 |
| Control-panel bezel | Norwegian (NO)             | CB532-40017 |
| Control-panel bezel | Portuguese (PT)            | CB532-40011 |
| Control-panel bezel | Swedish (SV)               | CB532-40016 |
| Control-panel bezel | Czech (CS)                 | CB532-40021 |
| Control-panel bezel | Hungarian (HU)             | CB532-40022 |
| Control-panel bezel | Polish (PL)                | CB532-40023 |
| Control-panel bezel | Russian (RU)               | CB532-40020 |
| Control-panel bezel | Slovak (SK)                | CB532-40024 |
| Control-panel bezel | Turkish (TR)               | CB532-40025 |
| Control-panel bezel | Arabic (AR)                | CB532-40028 |
| Control-panel bezel | Greek (EL)                 | CB532-40026 |
| Control-panel bezel | Hebrew (HE)                | CB532-40027 |
| Control-panel bezel | Korean (KO)                | CB532-40030 |
| Control-panel bezel | Simplified Chinese (ZHCN)  | CB532-40031 |
| Control-panel bezel | Traditional Chinese (ZHTW) | CB532-40029 |
| Control-panel bezel | Thai (TH)                  | CB532-40032 |
| Control-panel bezel | Vietnamese (VI)            | CB532-40033 |
| Control-panel bezel | Catalan (CA)               | CB532-40037 |
| Control-panel bezel | Romanian (RO)              | CB532-40038 |
| Control-panel bezel | Croatian (HR)              | CB532-40039 |
| Control-panel bezel | Slovenian (SL)             | CB532-40040 |
| Control-panel bezel | Indonesian (ID)            | CB532-40041 |
| Control-panel bezel | Kazakh (KK)                | CB532-40042 |

**Table 7-3 Control-panel bezels (continued)**

| Item                | Language        | Part number  |
|---------------------|-----------------|--------------|
| Control-panel bezel | Bulgarian (BG)  | CB532-40043  |
| Control-panel bezel | Ukranian (UK)   | CB532-40044  |
| Control-panel bezel | Serbian (SR)    | CB532-40045  |
| Control-panel bezel | Lithuanian (LT) | CB532-40046  |
| Control-panel bezel | Estonia (ET)    | CB532-400473 |
| Control-panel bezel | Latvian (LV)    | CB532-40048  |

# Supplementary documentation and support

**Table 7-4 Service and training support**

| Item                         | Part number |
|------------------------------|-------------|
| Service manual (this manual) | CB532-90946 |

A printed copy of the user guide is available in the following languages.

**Table 7-5 User guides**

| Language              | Part number |
|-----------------------|-------------|
| English               | CB532-90901 |
| Chinese, simplified   | CB532-90908 |
| Czech                 | CB532-90910 |
| Dutch                 | CB532-90912 |
| French                | CB532-90902 |
| German                | CB532-90903 |
| Hungarian             | CB532-90916 |
| Italian               | CB532-90904 |
| Korean                | CB532-90919 |
| Polish                | CB532-90923 |
| Portuguese, Brazil    | CB532-90924 |
| Russian               | CB532-90926 |
| Spanish, Mid Atlantic | CB532-90905 |
| Swedish               | CB532-90930 |
| Thai                  | CB532-90931 |
| Traditional Chinese   | CB532-90932 |
| Turkish               | CB532-90933 |
| Catalan               | CB532-90906 |
| Bulgarian             | CB532-90907 |
| Croatian              | CB532-90909 |
| Danish                | CB532-90911 |
| Estonian              | CB532-90913 |
| Finnish               | CB532-90914 |
| Greek                 | CB532-90915 |
| Bahasa Indonesian     | CB532-90917 |
| Kazakh                | CB532-90918 |
| Latvian               | CB532-90920 |

**Table 7-5 User guides (continued)**

| Language   | Part number |
|------------|-------------|
| Lithuanian | CB532-90921 |
| Norwegian  | CB532-90922 |
| Romanian   | CB532-90925 |
| Serbian    | CB532-90927 |
| Slovak     | CB532-90928 |
| Slovenian  | CB532-90929 |
| Ukrainian  | CB532-90934 |
| Vietnamese | CB532-90935 |
| Arabic     | CB532-90936 |
| Hebrew     | CB532-90937 |

A printed copy of the Getting Started Guide is available in the following languages.

**Table 7-6 Getting started guide**

| Language   | Part number |
|--|-------------|
| English, Spanish, Portuguese, French   | CB532-90938 |
| English, Spanish, Portuguese, Catalan, Dutch, French, German, Italian                  | CB532-90939 |
| English, Danish, Finnish, French, Norwegian, Swedish, Arabic                           | CB532-90940 |
| English, Bulgarian, Czech, Hungarian, Polish, Romanian, Russian, Slovak                | CB532-90941 |
| English, Kazakh, Turkish, Ukrainian, Estonian, Latvian, Lithuanian                     | CB532-90942 |
| English, Croatian, Greek, Serbian, Slovenian, Hebrew                                   | CB532-90943 |
| English, Korean, Indonesian, Simplified Chinese, Traditional Chinese, Thai, Vietnamese | CB532-90944 |

**Table 7-7 Technical support Web sites**

|  |  |
|--|--|
| <b>HP Customer Care Online</b>   | <a href="http://www.hp.com/support/LJM2727">www.hp.com/support/LJM2727</a>         |
| Software drivers, support documentation, and answers to frequently asked questions |  |
| <b>HP Technical Training (North America)</b>                                       | <a href="http://www.hp.com/go/resellertraining">www.hp.com/go/resellertraining</a> |
| Classes and schedules  |  |



# Problem-solve diagrams

- [Repetitive image defects](#)
- [Interface connectors](#)
- [Formatter connectors](#)
- [Fax card](#)
- [Solenoids](#)
- [Switches and sensors](#)
- [Rollers and pads](#)
- [PCAs \(base unit\)](#)
- [Major components \(base unit\)](#)
- [Scanner and ADF](#)
- [Circuit diagram \(1 of 2\)](#)
- [Circuit diagram \(2 of 2\)](#)

## Repetitive image defects

If the product output has a consistent, repetitive defect, then use [Table 7-8 Repetitive image defects on page 259](#) to determine which part needs to be replaced based on the measured distance between the repetitions of the defect.

 **NOTE:** The following table replaces the graphical repetitive defect ruler. You can make your own ruler by using these measurements.

**Table 7-8 Repetitive image defects**

| Distance between identical defects | Dirty or damaged roller | Solution   |
|------------------------------------|-------------------------|--|
| 37.7 mm (1.48 inches)              | Primary charging roller | Replace the print cartridge.   |
| 43.0 mm (1.69 inches)              | Registration roller     | Replace the registration assembly (see <a href="#">Registration-roller assembly on page 161</a> ). |
| 44.0 mm (1.73 inches)              | Developing cylinder     | Replace the print cartridge.   |
| 46.2 mm (1.82 inches)              | Transfer roller         | Replace the transfer roller.   |
| 56.5 mm (2.22 inches)              | Fuser film              | Replace the fuser (see <a href="#">Fuser on page 147</a> ).  |
| 69.0 mm (2.72 inches)              | Pressure roller         | Replace the fuser (see <a href="#">Fuser on page 147</a> ).  |
| 75.4 mm (2.97 inches)              | Photosensitive drum     | Replace the print cartridge.   |

## Interface connectors

Figure 7-1 Interface connectors

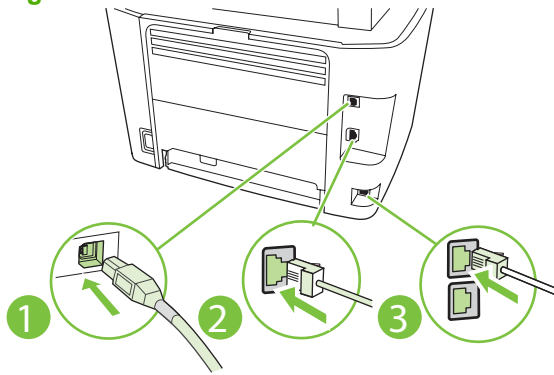

Table 7-9 Interface connectors

|   |                       |
|---|-----------------------|
| 1 | Hi-speed USB 2.0 port |
| 2 | Network port          |
| 3 | Fax ports             |

## Formatter connectors

Figure 7-2 Formatter connectors

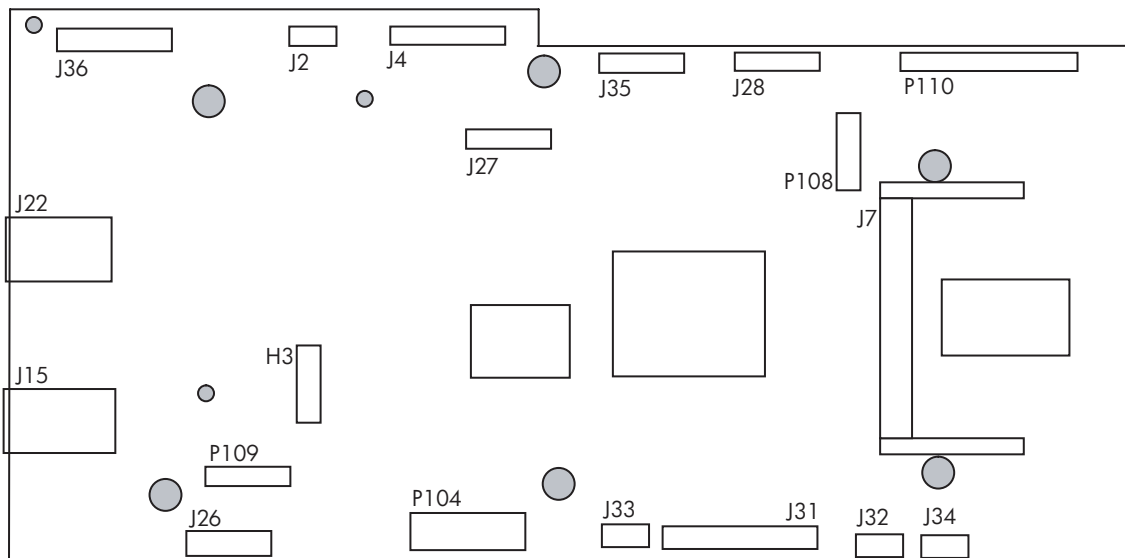

Table 7-10 Formatter connectors

| Item | Description   |
|------|---|
| H3   | Asian character control panel display PCA<br><br><b>NOTE:</b> This PCA is only installed on products that use the Asian fax control panel display. Not all products will have this PCA installed. |
| J2   | Flatbed motor   |

**Table 7-10 Formatter connectors (continued)**

| Item | Description               |
|------|---------------------------|
| J4   | Scanner                   |
| J7   | Dimm slot                 |
| J15  | Network port              |
| J22  | High-speed USB 2.0 port   |
| J26  | Fax card PCA              |
| J27  | Control panel             |
| J28  | Laser video               |
| J31  | ECU PCA                   |
| J32  | Speaker                   |
| J33  | +3.3V (from the engine)   |
| J34  | Tray 1 solenoid (MP tray) |
| J35  | Memory tag (E-label)      |
| J36  | ADF motor                 |
| P104 | BDM                       |
| P108 | Serial                    |
| P109 | SPI module                |
| P110 | Ansible trace monitor     |

## Fax card

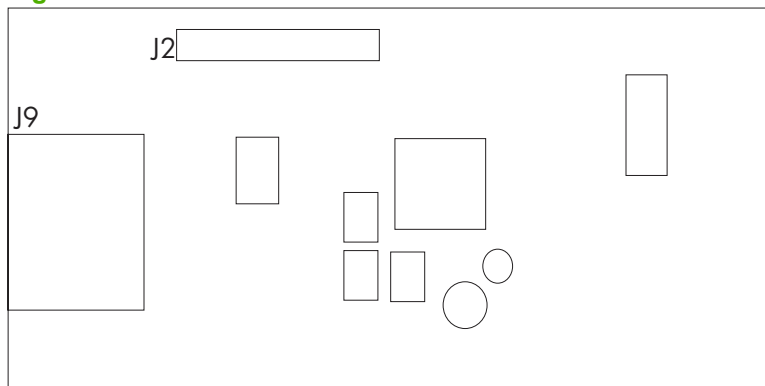
**Figure 7-3 Fax card connectors****Table 7-11 Fax card**

| Item | Description |
|------|-------------|
| J2   | Formatter   |
| J9   | Fax ports   |

## Solenoids

Figure 7-4 Solenoids

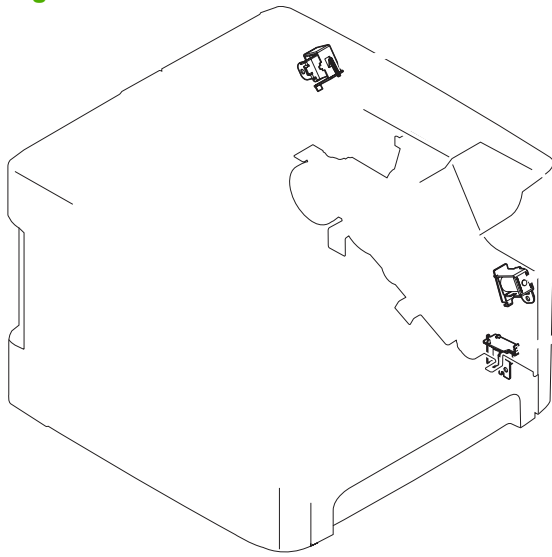

Table 7-12 Solenoids

| Item | Description            |
|------|------------------------|
| 1    | Duplex solenoid        |
| 2    | Tray 1 pickup solenoid |
| 3    | Tray 2 pickup solenoid |

## Switches and sensors

Figure 7-5 Switches and sensors

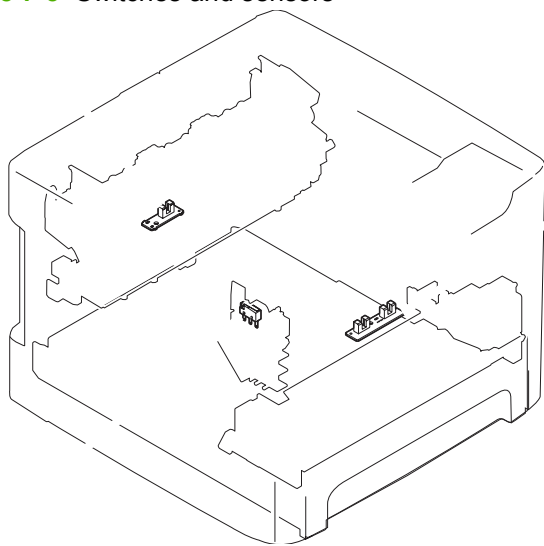

Table 7-13 Switches and sensors

| Item | Description        |
|------|--------------------|
| 1    | Interlock switch   |
| 2    | Delivery sensor    |
| 3    | Top-of-page sensor |

## Rollers and pads

Figure 7-6 Rollers and pads

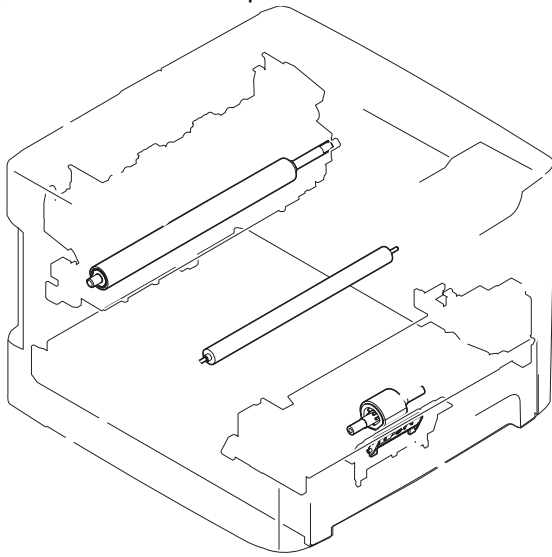

Table 7-14 Rollers and pads

| Item | Description     |
|------|-----------------|
| 1    | Transfer roller |
| 2    | Pressure roller |
| 3    | Pickup roller   |
| 4    | Separation pad  |

## PCAs (base unit)

Figure 7-7 PCAs (base unit)

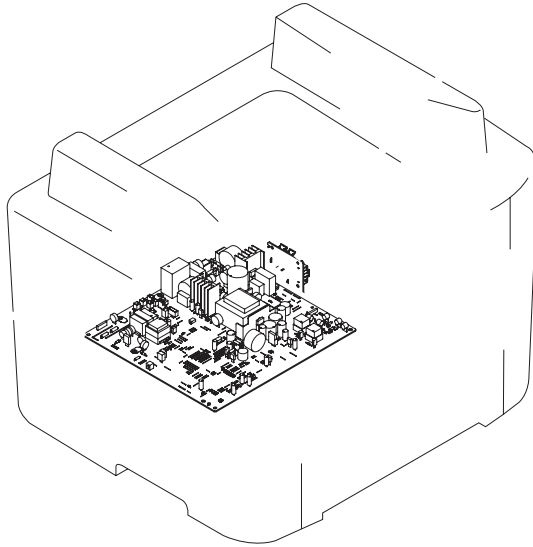

Table 7-15 PCAs (base unit)

| Item | Description                      |
|------|----------------------------------|
| 1    | Engine-controller assembly (ECU) |
| 2    | Power-switch PCA                 |

## Major components (base unit)

Figure 7-8 Major components (base unit)

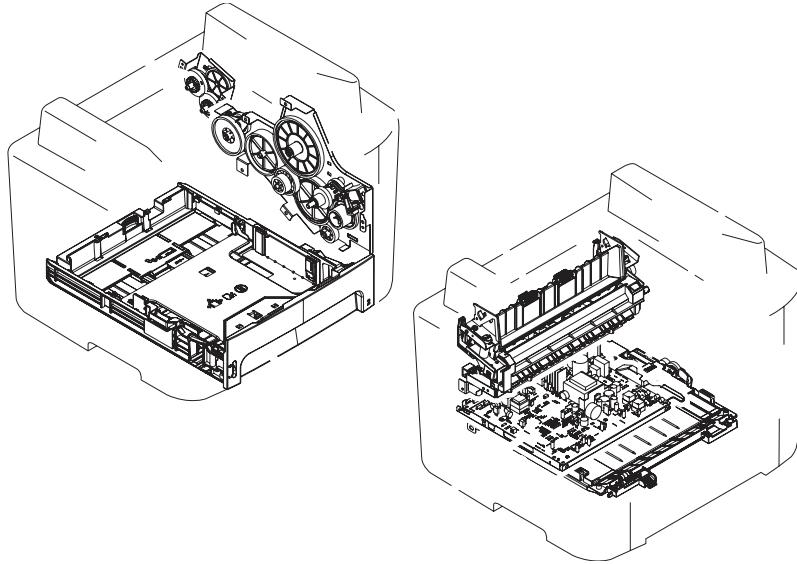

Table 7-16 Major components (base unit)

| Item | Description                      |
|------|----------------------------------|
| 1    | Duplex-drive gears               |
| 2    | Main-drive assembly              |
| 3    | Duplex-drive assembly            |
| 4    | Engine-controller assembly (ECU) |
| 5    | Tray 2 cassette                  |
| 6    | Fuser                            |



## Scanner and ADF

Figure 7-9 Scanner and ADF

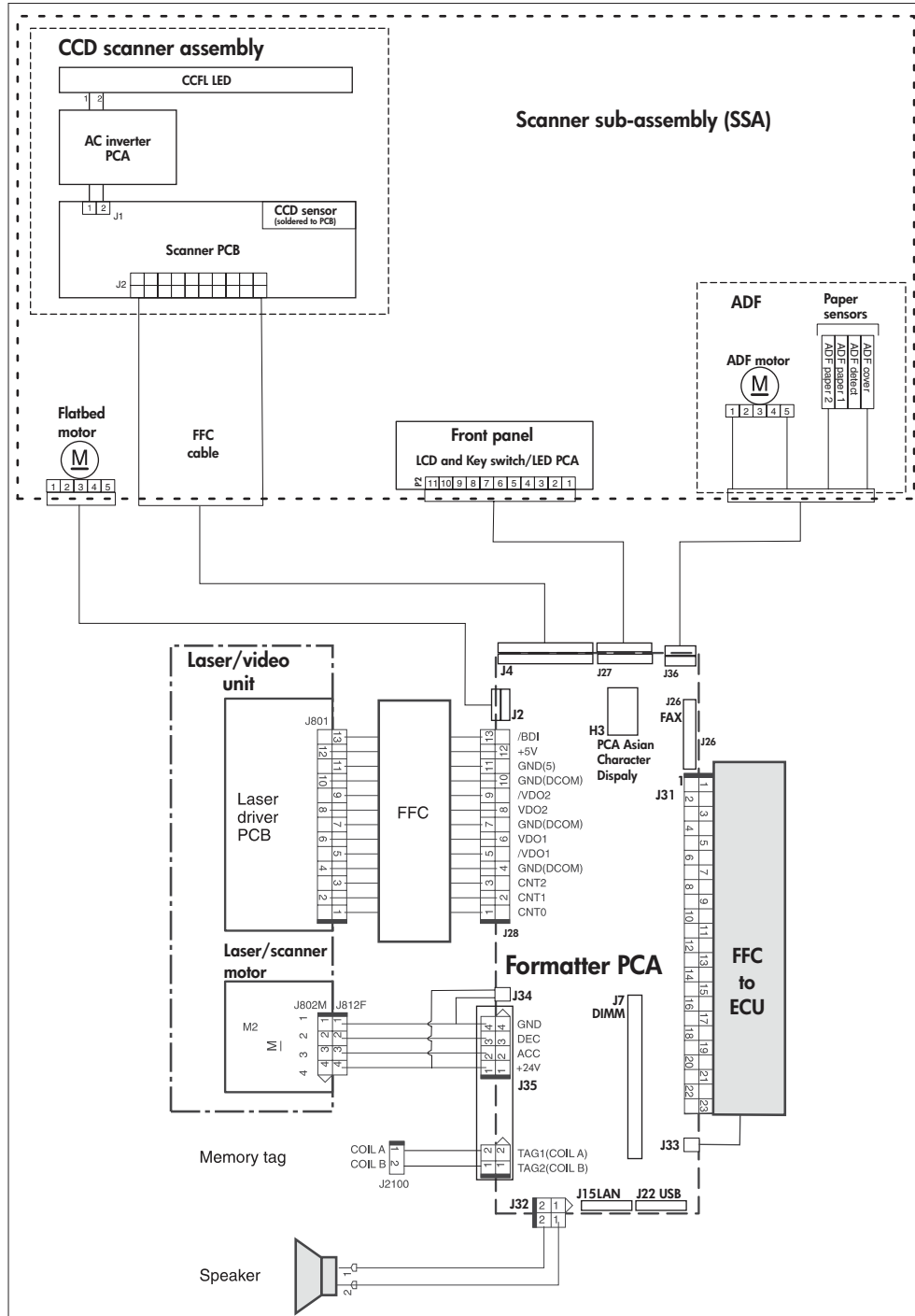

Table 7-17 Scanner and ADF

| Item | Description |
|------|-------------|
| 1    | Scanner     |
| 2    | ADF         |

# Circuit diagram (1 of 2)

Figure 7-10 Circuit diagram (1 of 2)



# Circuit diagram (2 of 2)

Figure 7-11 Circuit diagram (2 of 2)

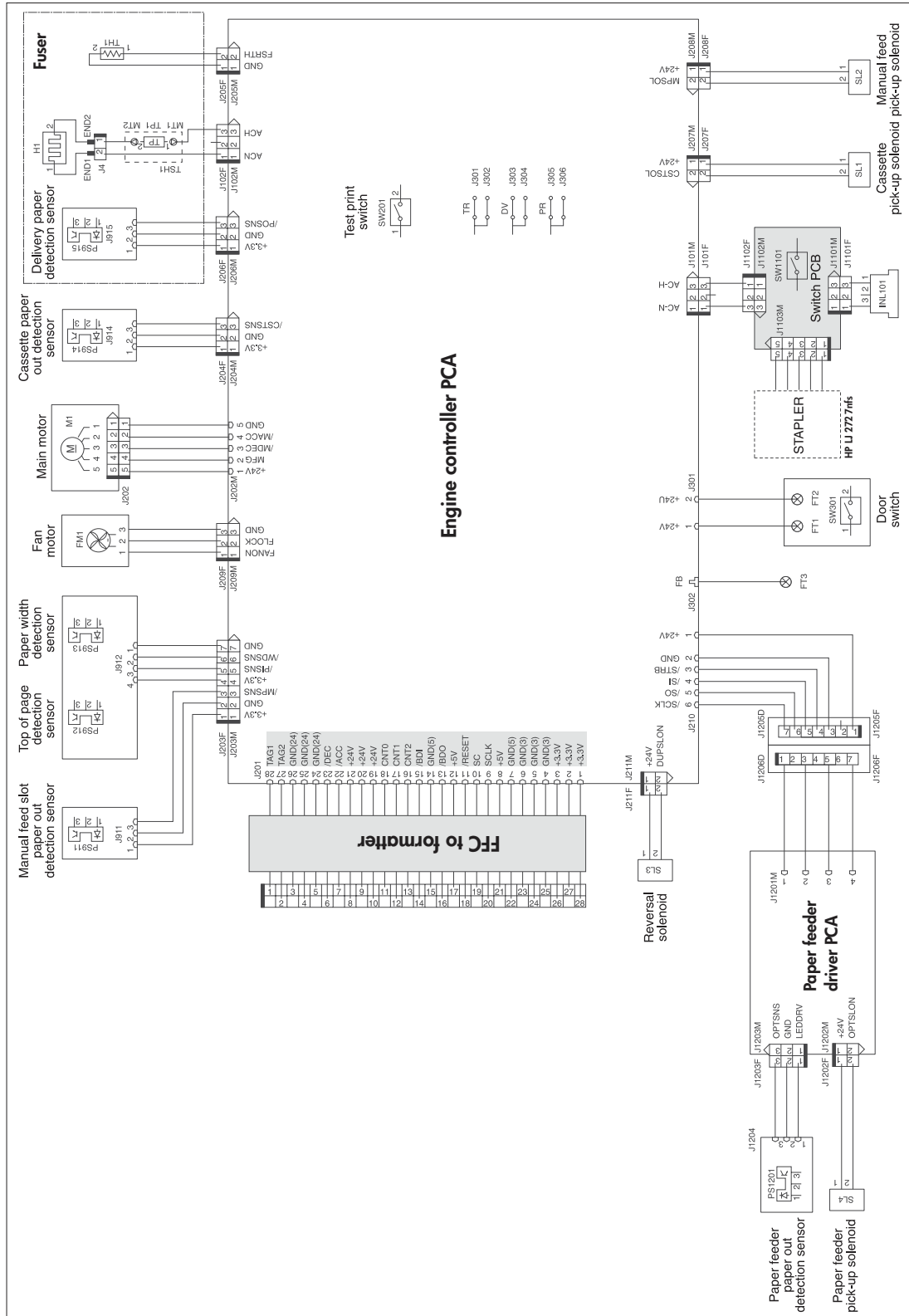

# Parts lists and diagrams

## How to use the parts lists and diagrams

The figures in this chapter show the major subassemblies in the product and their component parts. A parts list table follows each exploded view assembly diagram. Each table lists the item number, the associated part number, and the description of each part. If a part is not listed in the table, then it is not a field replaceable unit (FRU).







---

**CAUTION:** Be sure to order the correct part. When looking for part numbers for electrical components, pay careful attention to the voltage that is listed in the description column to ensure that the part number selected is for the correct product model.

 **NOTE:** In this manual, the abbreviation “PCA” stands for “printed circuit board assembly.” Components described as a PCA might consist of a single circuit board or a circuit board plus other parts, such as cables and sensors.

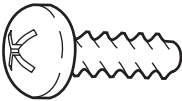
---

## Types of screws

| Illustration  | Description                  | Size  | Part number    | Use   |
|---|------------------------------|-------|----------------|---|
|    | Screw, RS                    | M3X6  | XA9-1495-000CN | Used to secure metal to metal   |
|   |                              | M3X6  | XA9-1561-000CN |   |
|   |                              | M3X8  | XA9-1504-000CN |   |
|    | Screw w/washer               | M3X8  | XA9-1420-000CN | Used to secure metal components to metal components (for example, a ground wire to the frame) |
|   |                              | M4X12 | XA9-1492-000CN |   |
|    | Screw, tapping               | M3X6  | XB9-1503-000CN | Used to secure anything to plastic  |
|    | Screw, tapping, truss head   | M4X10 | XB4-7401-005CN | Used to secure anything to plastic  |
|    | Screw, tapping binding, head | M3X8  | XB4-7300-809CN | Used to secure anything to plastic  |
|    | Screw, toothed washer        | M4X6  | XB2-7400-606CN | Used to secure metal components to metal components   |
|  | Screw, TP                    | M3X8  | XA-1648-000CN  | Used to secure anything to plastic  |

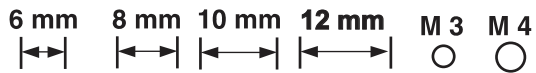

# Scanner and ADF assemblies

Figure 7-12 Scanner and ADF assemblies

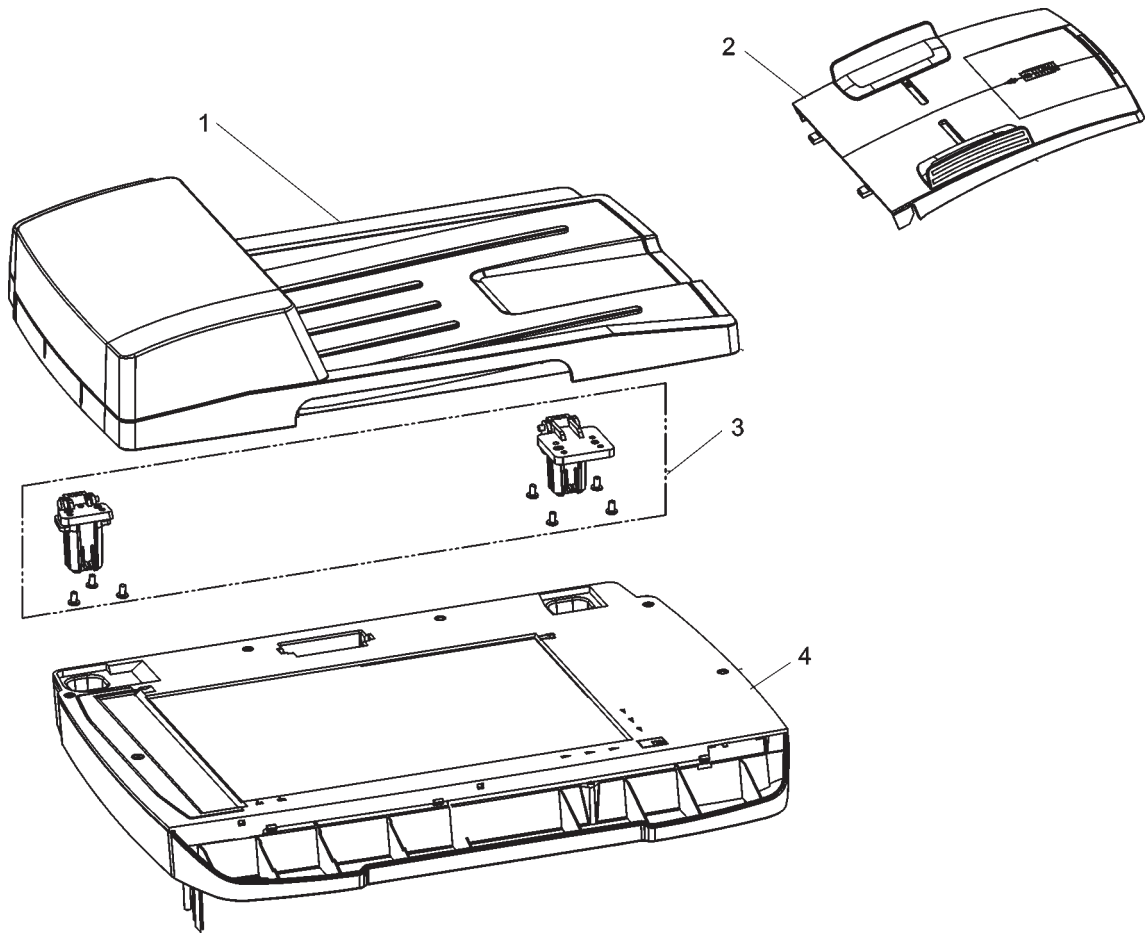
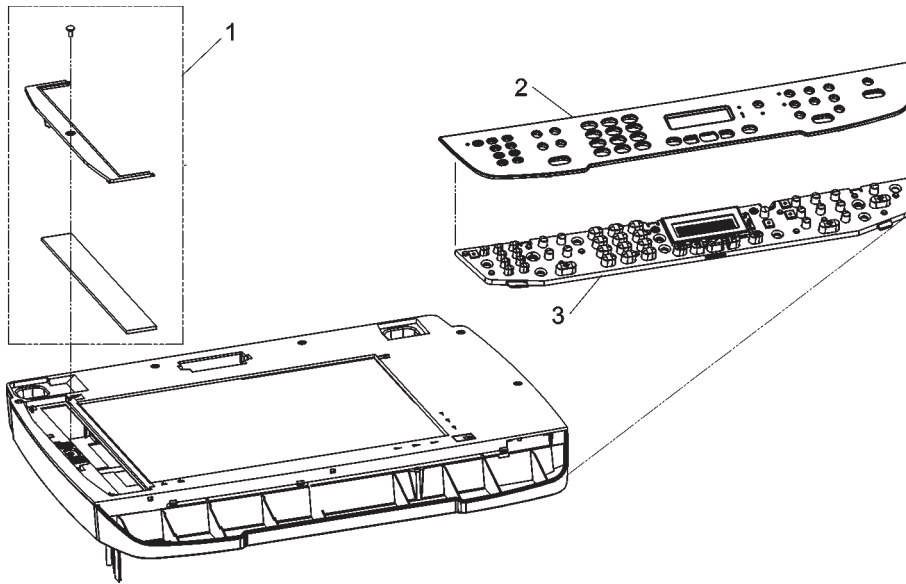

**Table 7-18 Scanner and ADF assemblies**

| <b>Ref</b> | <b>Description</b>                           | <b>Part number</b> | <b>Qty</b> |
|------------|--|--------------------|------------|
| 1          | ADF PKG FGI ASSY (automatic document feeder) | CB532-67903        | 1          |
| 2          | Input tray assembly HP LaserJet M2727        | Q6500-60119        | 1          |
| 3          | ADF hinge replacement kit                    | Q3948-67905        | 1          |
| 4          | SSA PKG FGI ASSY (scanner flatbed assembly)  | CB532-67905        | 1          |

# Scanner components

Figure 7-13 Scanner assemblies





**Table 7-19 Scanner components**

| Ref | Description                | Part number  | Qty |
|-----|----------------------------|--|-----|
| 1   | ADF window replacement kit | Q6500-67904  | 1   |
| 2   | Bezel, control panel       | See <a href="#">Control-panel bezels on page 255</a> . | 1   |
| 3   | Control panel, Western fax | CB532-60101  | 1   |
| 3   | Control panel, Asian fax   | CB532-60102  | 1   |

 **NOTE:** The Asian character control panel display PCA (see [Formatter, fax card, HP jewel, and nameplate on page 280](#)) must be installed on the formatter to support the Asian fax control panel (CB532-60102).

# ADF components

Figure 7-14 ADF components

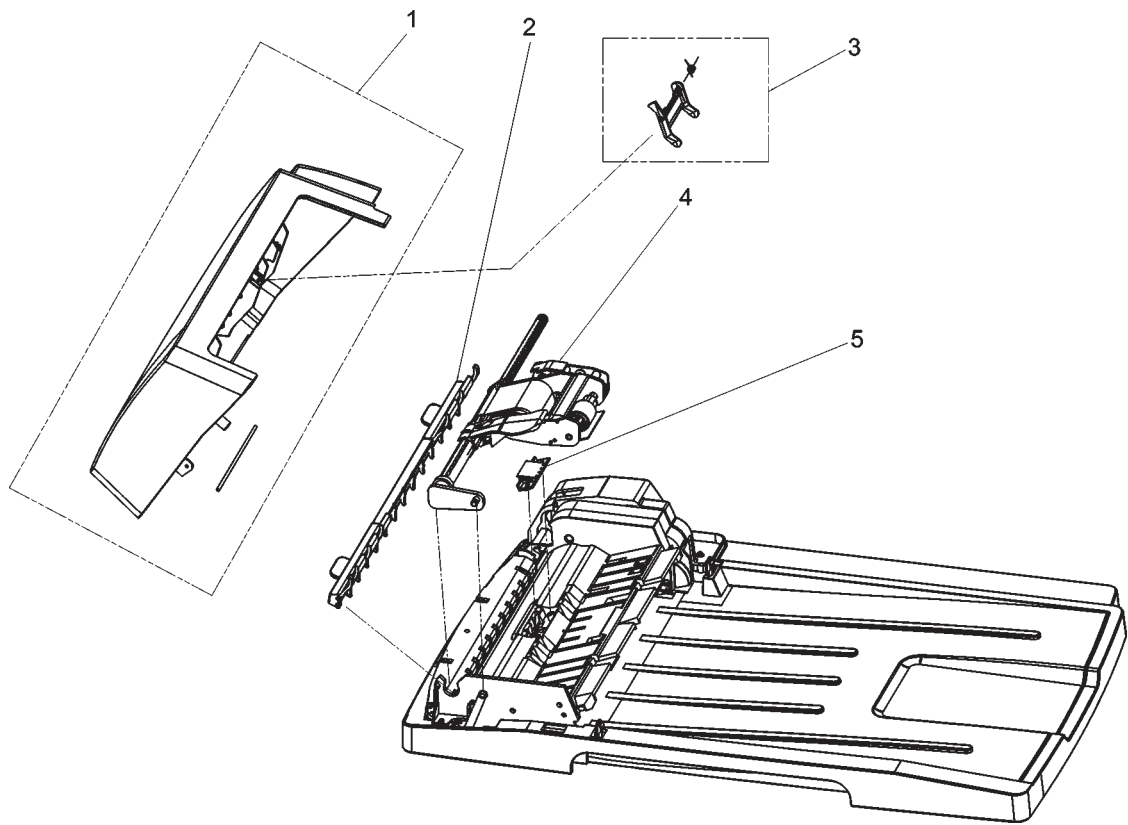
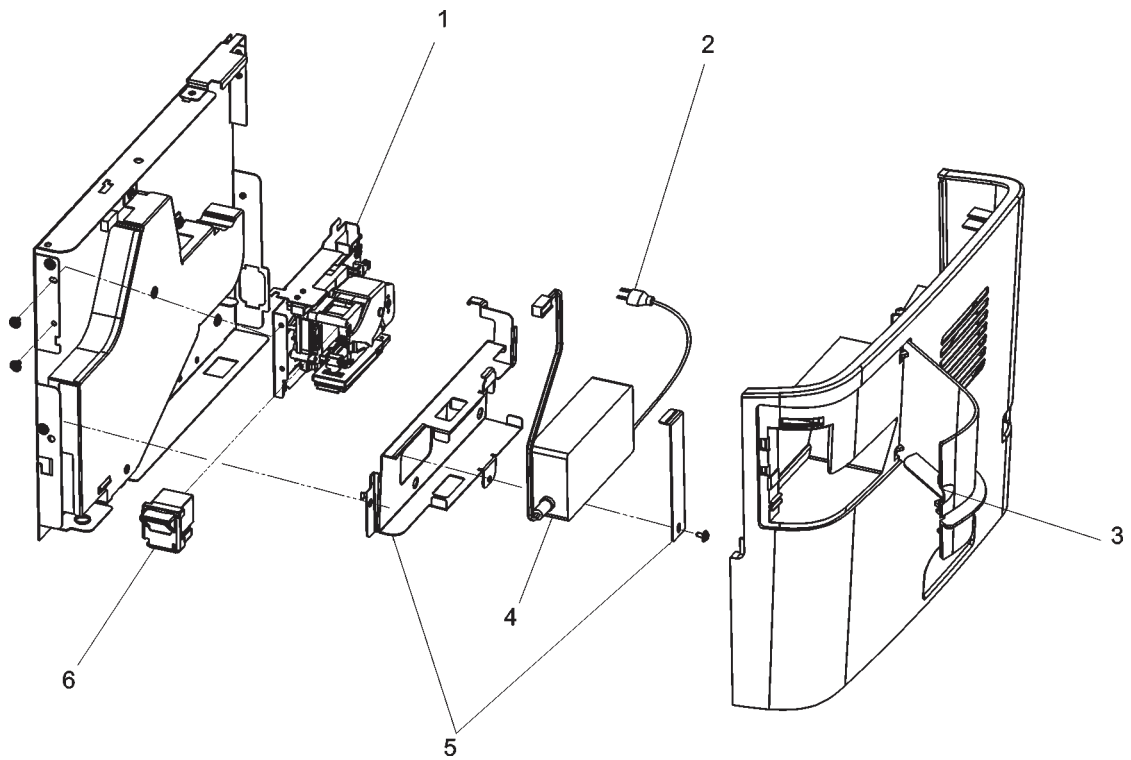

**Table 7-20 ADF components**

| <b>Ref</b> | <b>Description</b>         | <b>Part number</b> | <b>Qty</b> |
|------------|----------------------------|--------------------|------------|
| 1          | ADF cover replacement kit  | Q6500-67901        | 1          |
| 2          | ADF cleanout part          | C7309-40153        | 1          |
| 3          | ADF flag replacement kit   | Q3948-67902        | 1          |
| 4          | ADF pickup roller assembly | 5851-2559          | 1          |
| 5          | ADF separation pad         | Q2665-60125        | 1          |

# Convenience stapler components (HP LaserJet M2727nfs only)

Figure 7-15 Convenience stapler components (HP LaserJet M2727nfs only)



**Table 7-21 Convenience stapler components (HP LaserJet M2727nfs only)**

| Ref | Description   | Part number    | Qty |
|-----|---|----------------|-----|
| 1   | Convenience stapler mechanism HP LaserJet M2727nfs (replacement)        | CB532-60105    | 1   |
| 2   | Convenience stapler AC inlet cable HP LaserJet M2727nfs                 | Q6501-60101    | 1   |
| 3   | Convenience stapler cover door HP LaserJet M2727nfs                     | RC1-7523-000CN | 1   |
| 4   | Convenience stapler power supply HP LaserJet M2727nfs                   | Q7429-60501    | 1   |
| 5   | Convenience stapler power supply bracket and strap HP LaserJet M2727nfs | CB532-67902    | 1   |
| 6   | Convenience stapler cassette (2-pack) HP LaserJet M2727nfs              | Q7432-67001    | 1   |

 **NOTE:** The convenience stapler components are used in the HP LJ3392 and the HP LaserJet M2727nfs.

# Formatter, fax card, HP jewel, and nameplate

Figure 7-16 Formatter, fax card, HP jewel, and nameplate

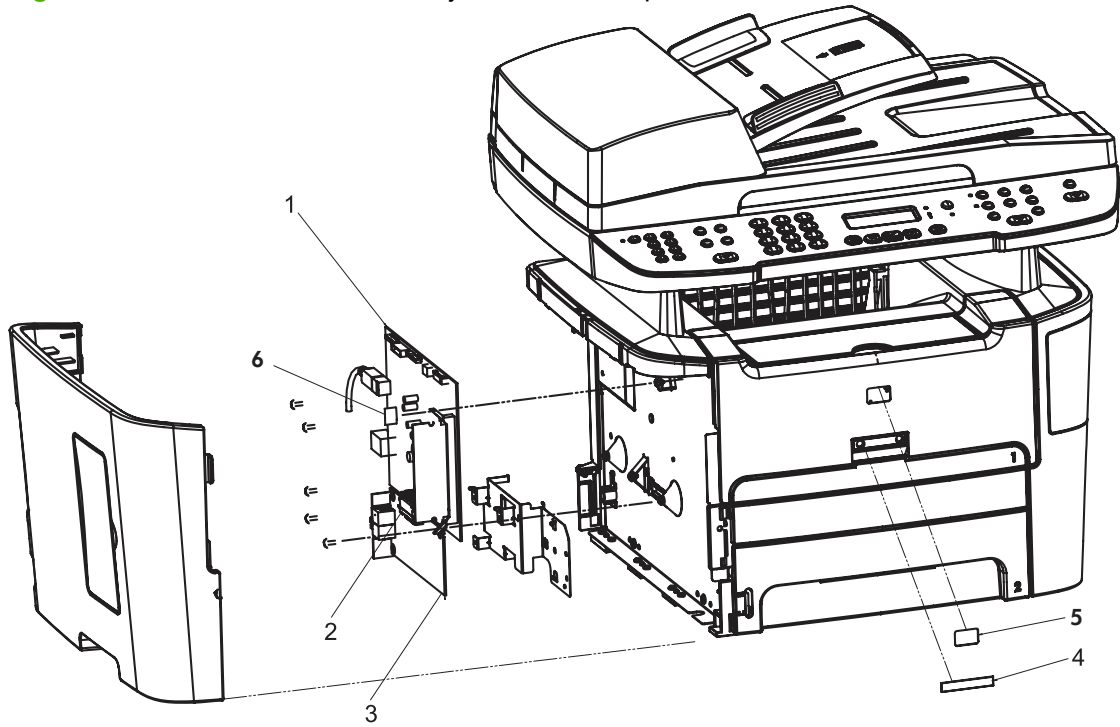

**Table 7-22 Formatter, Fax card, HP jewel, and nameplate**

| Ref | Description  | Part number | Qty |
|-----|--|-------------|-----|
| 1   | Formatter PCA  | CC370-60001 | 1   |
| 2   | Fax card/Formatter FFC                                   | CB534-60117 | 1   |
| 3   | Fax card US/AP ROHS                                      | CC502-60001 | 1   |
| 3   | Fax card EMEA ROHS                                       | CC369-60001 | 1   |
| 4   | Nameplate HP LaserJet M2727nf                            | CB532-00009 | 1   |
| 4   | Nameplate HP LaserJet M2727nfs                           | CB532-00003 | 1   |
| 5   | Jewel, HP  | 7121-8285   | 1   |
| 6   | PCA, Asian character display control panel (with spacer) | CB532-67904 | 1   |

 **NOTE:** The Asian character display control panel PCA (CB532-67904) is only installed on products that use the Asian fax control panel.

# External covers and panels

Figure 7-17 External covers and panels

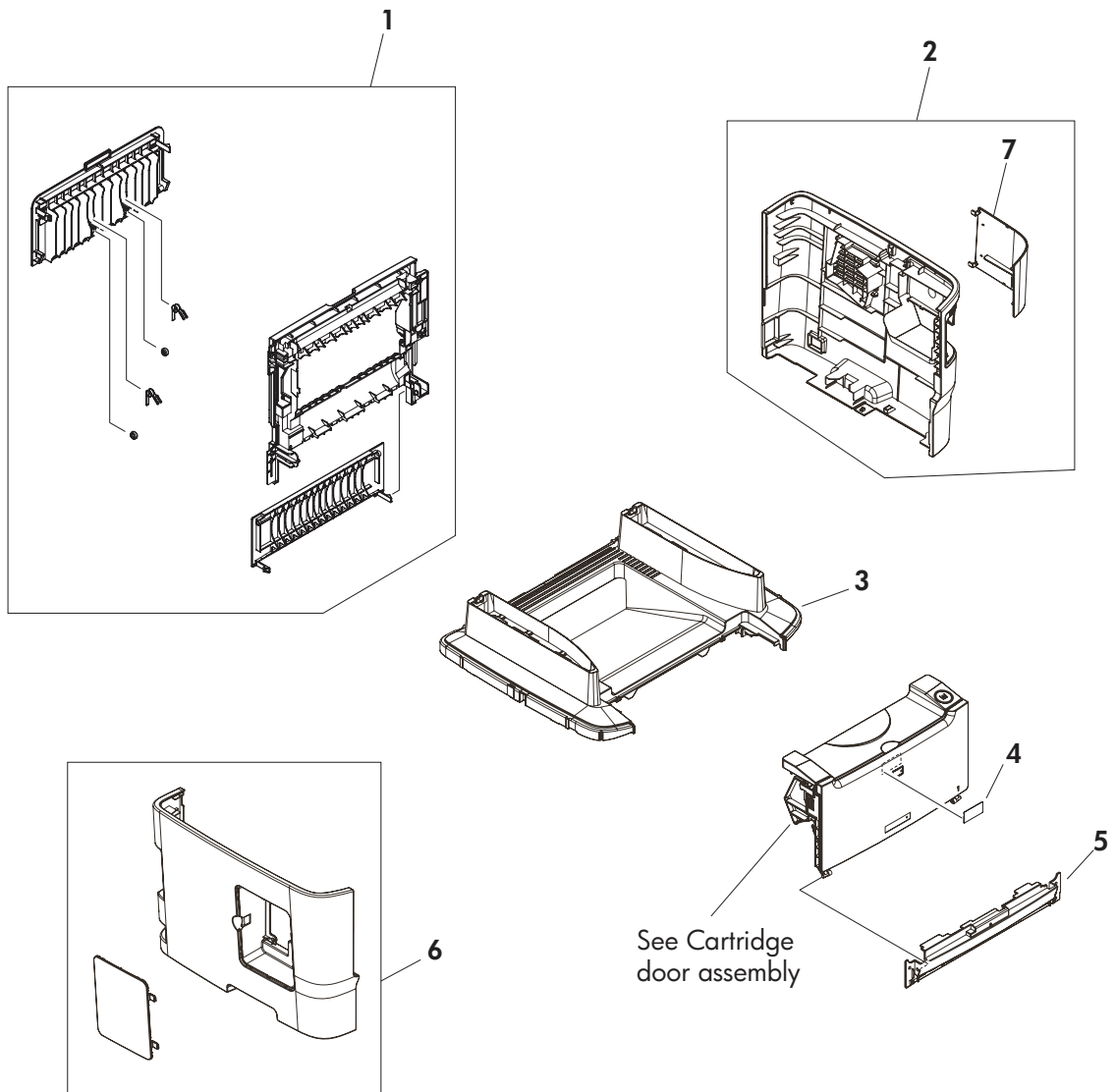

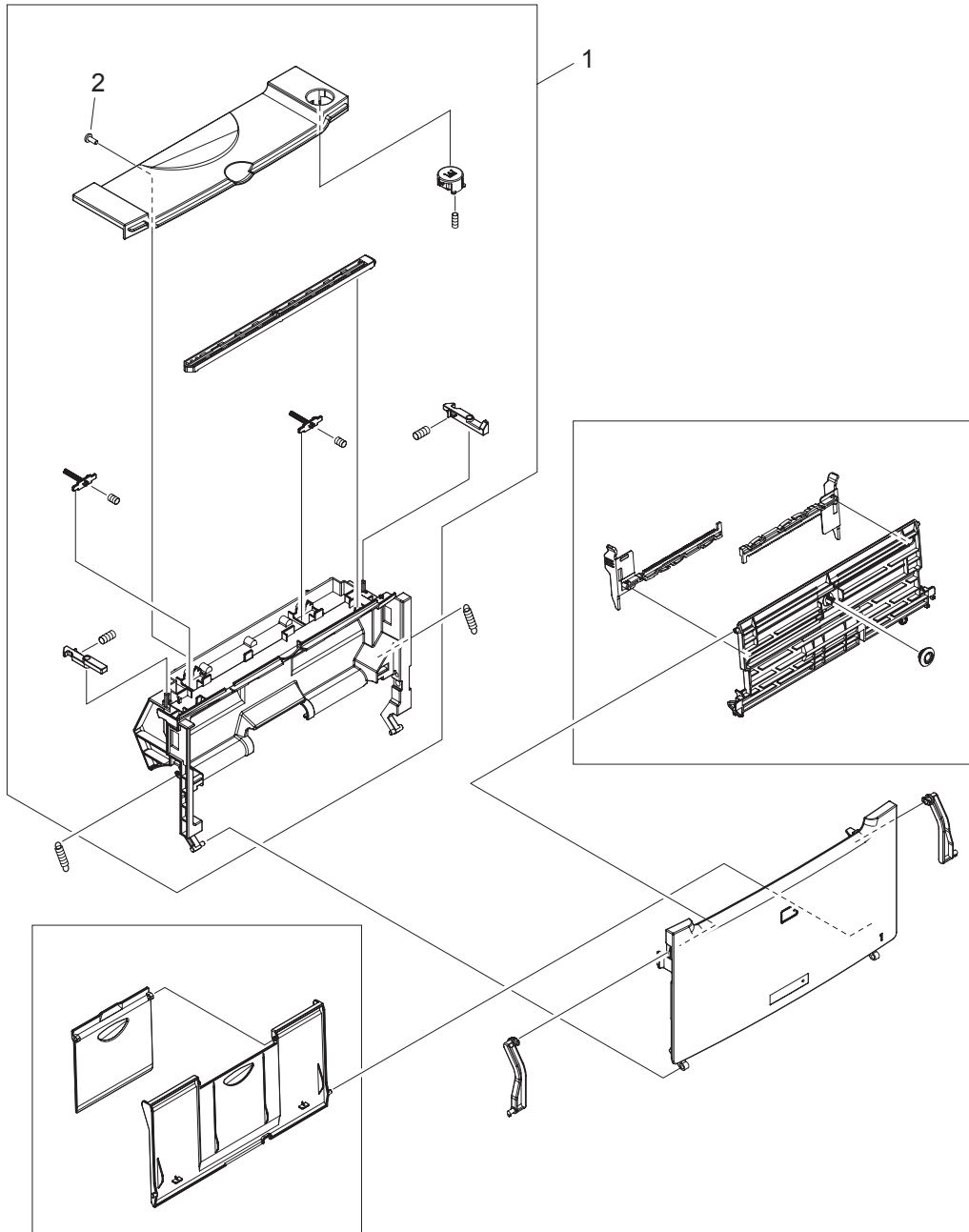

**Table 7-23 External covers and panels**

| <b>Ref</b> | <b>Description</b>                              | <b>Part number</b> | <b>Qty</b> |
|------------|---|--------------------|------------|
| 1          | Rear cover assembly                             | RM1-4270-000CN     | 1          |
| 2          | Cover right (with dummy stapler cover)          | RM1-4708-000CN     | 1          |
| 3          | Cover top                                       | RC2-2940-000CN     | 1          |
| 4          | Label, stapler prohibition                      | RC1-3794-000CN     | 1          |
| 5          | Cover front                                     | RC2-0330-000CN     | 1          |
| 6          | Cover left (with DIMM door)                     | RC1-4707-000CN     | 1          |
| 7          | Cover dummy (stapler plug; HP LaserJet M2727nf) | RC1-7523-000CN     | 1          |

# Cartridge door assembly

Figure 7-18 Cartridge door assembly

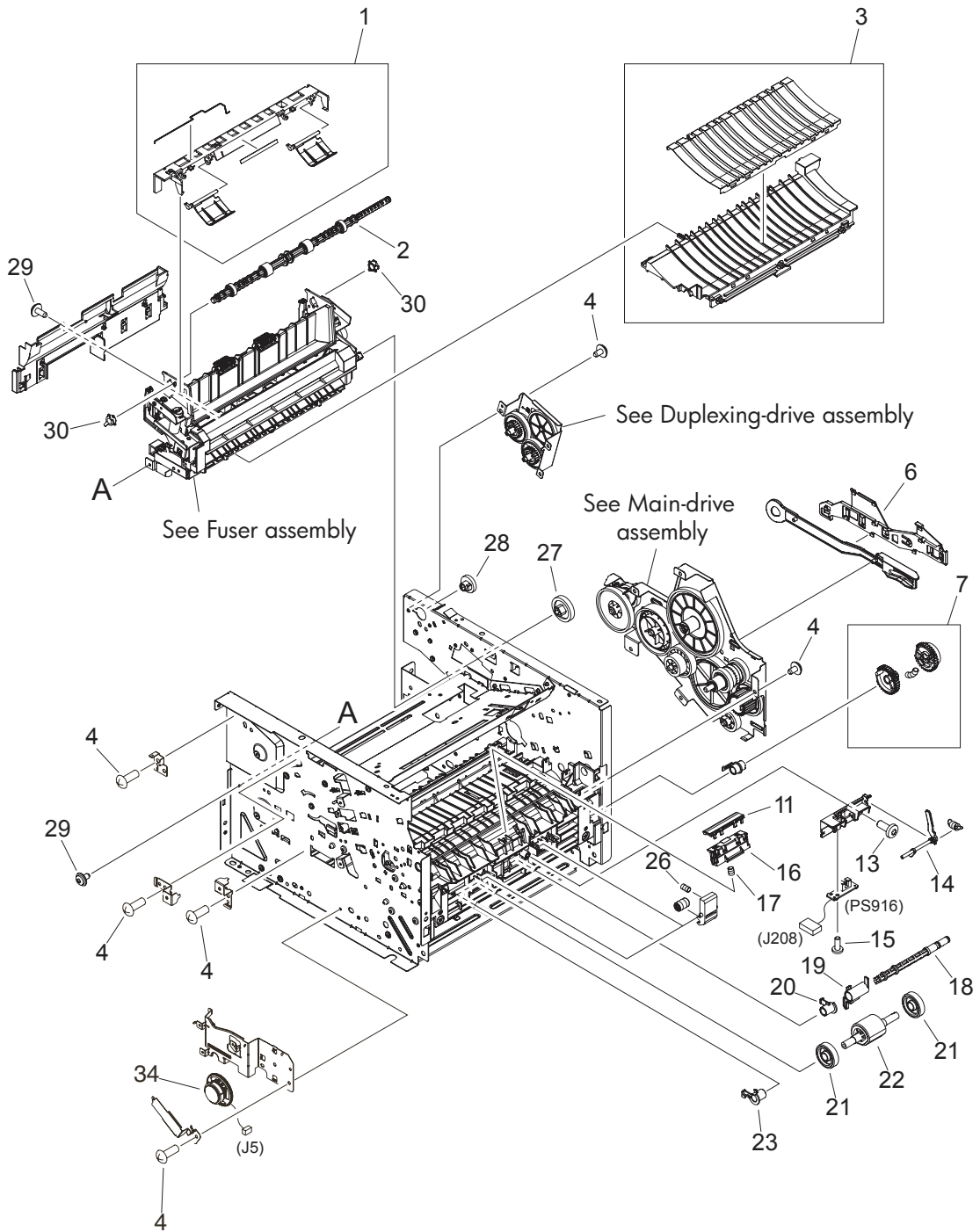

**Table 7-24 Cartridge door assembly**

| <b>Ref</b> | <b>Description</b>      | <b>Part number</b> | <b>Qty</b> |
|------------|-------------------------|--------------------|------------|
| All        | Cartridge door assembly | RM1-4711-000CN     | 1          |
| 1          | Inner cover             | RM1-4712-000CN     | 1          |
| 2          | Screw, tapping truss    | XB4-7401-000CN     | 2          |

# Internal components (1 of 4)

Figure 7-19 Internal components (1 of 4)

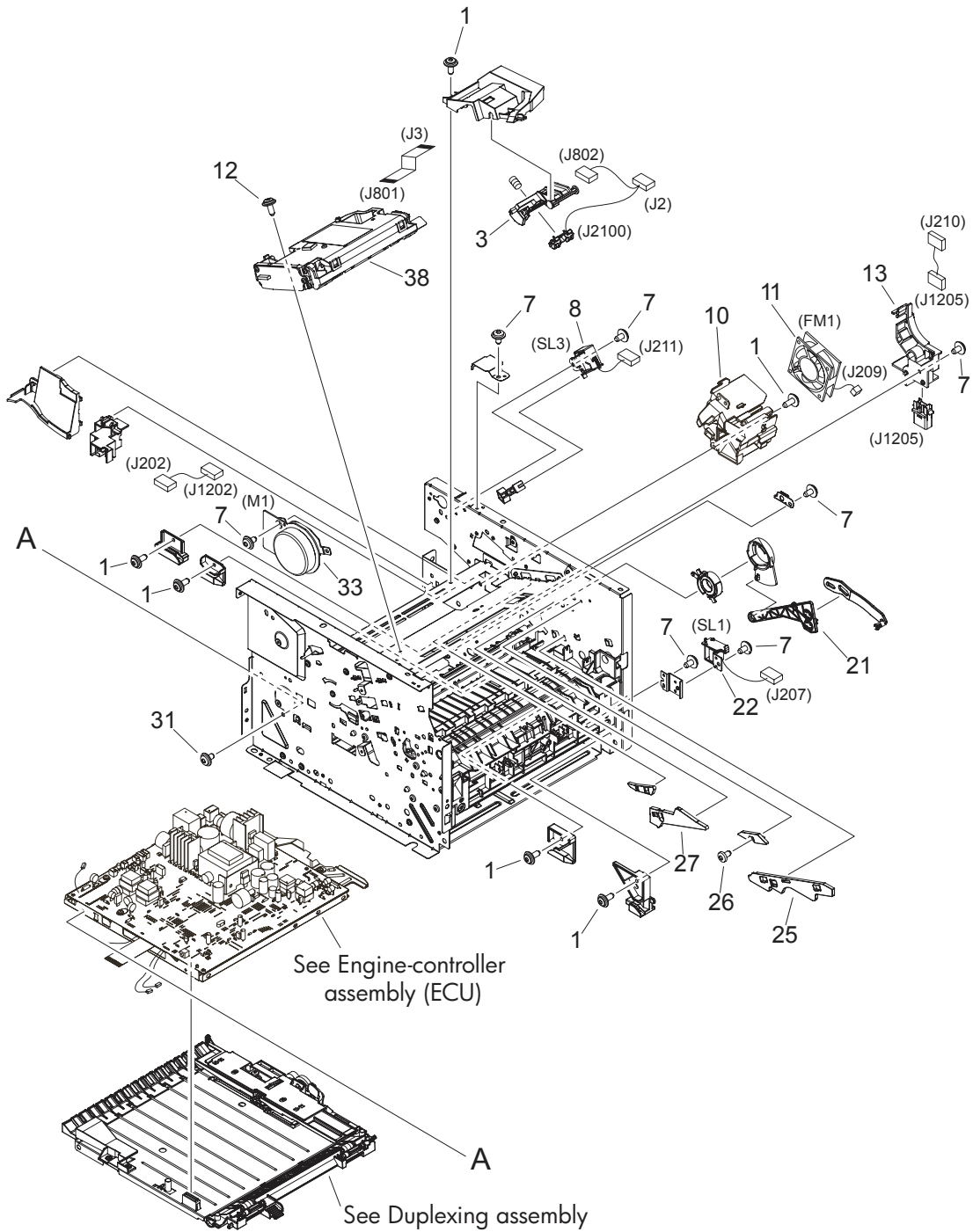

**Table 7-25 Internal components (1 of 4)**

| Ref | Description                      | Part number    | Qty |
|-----|----------------------------------|----------------|-----|
| 1   | Paper-retaining assembly         | RM1-4265-000CN | 1   |
| 2   | Roller, face down                | RL1-0527-000CN | 1   |
| 3   | Paper-feed guide assembly        | RM1-4263-000CN | 1   |
| 4   | Screw, RS M3X6                   | XA9-1495-000CN | 12  |
| 6   | Guide, DC cable 2                | RC2-1569-000CN | 1   |
| 7   | Paper-pickup gear assembly       | RM1-1301-000CN | 1   |
| 11  | MP separation pad (Tray 1)       | RL1-1524-000CN | 1   |
| 13  | Screw, tapping truss head M4X10  | XB4-7401-000CN | 1   |
| 15  | Screw, tapping binding head M3X8 | XB4-7300-000CN | 1   |
| 16  | Separation pad base              | RC2-0419-000CN | 1   |
| 17  | Spring, compression              | RU5-2894-000CN | 1   |
| 18  | Paper-pickup drive shaft         | RC1-3471-000CN | 1   |
| 19  | Flag, paper sensing              | RC1-3472-000CN | 1   |
| 20  | Right bushing                    | RB2-2895-000CN | 1   |
| 21  | Roller, paper-pickup idler       | RC1-3470-000CN | 2   |
| 22  | Roller, paper pickup             | RL1-0540-000CN | 1   |
| 23  | Left bushing                     | RB2-2896-000CN | 1   |
| 26  | Spring, compression              | RU5-2323-000CN | 2   |
| 27  | Gear, 29T                        | RU5-0331-000CN | 1   |
| 28  | Gear, 19T                        | RU5-0332-000CN | 1   |
| 29  | Screw, tap M3X6                  | XA9-1503-000CN | 5   |
| 30  | Bushing                          | RC1-3665-000CN | 2   |
| 34  | Speaker assembly                 | RM1-4943-000CN | 1   |

# Internal components (2 of 4)

Figure 7-20 Internal components (2 of 4)

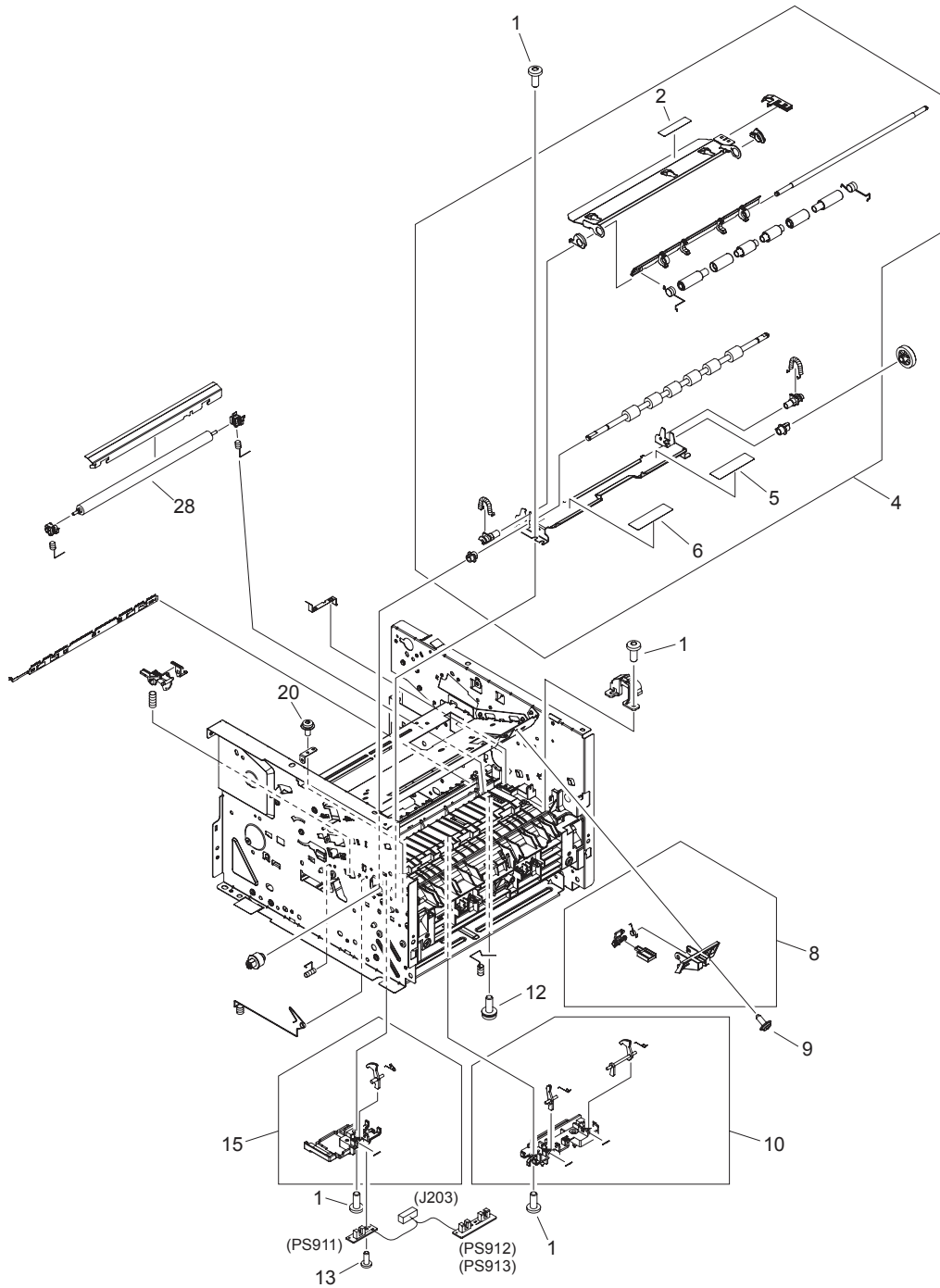

**Table 7-26 Internal components (2 of 4)**

| Ref | Description                      | Part number    | Qty |
|-----|----------------------------------|----------------|-----|
| 1   | Screw, RS M3X8                   | XA9-1504-000CN | 8   |
| 2   | Arm, cam                         | RC2-0405-000CN | 1   |
| 3   | Arm, tag                         | RC2-0392-000CN | 1   |
| 7   | Screw, RS M3X6                   | XA9-1495-000CN | 9   |
| 8   | Solenoid (SL3)                   | RK2-0910-000CN | 1   |
| 10  | Holder, fan                      | RC2-2946-000CN | 1   |
| 11  | Fan                              | RK2-2082-000CN | 1   |
| 12  | Screw, TP M3X8                   | XA9-1648-000CN | 4   |
| 13  | Holder, drawer connector         | RC2-0396-000CN | 1   |
| 22  | Solenoid (SL1)                   | RK2-0424-000CN | 1   |
| 25  | Guide, cartridge right lower     | RC2-0346-000CN | 1   |
| 26  | Screw, RS M3X8                   | XA9-1561-000CN | 1   |
| 27  | Guide, cartridge right upper     | RC1-0426-000CN | 1   |
| 31  | Screw, tap M3X6                  | XA9-1503-000CN | 3   |
| 33  | Motor, DC                        | RK2-1567-000CN | 1   |
| 38  | Scanner assembly (laser/scanner) | RM1-4262-000CN | 1   |

# Internal components (3 of 4)

Figure 7-21 Internal components (3 of 4)



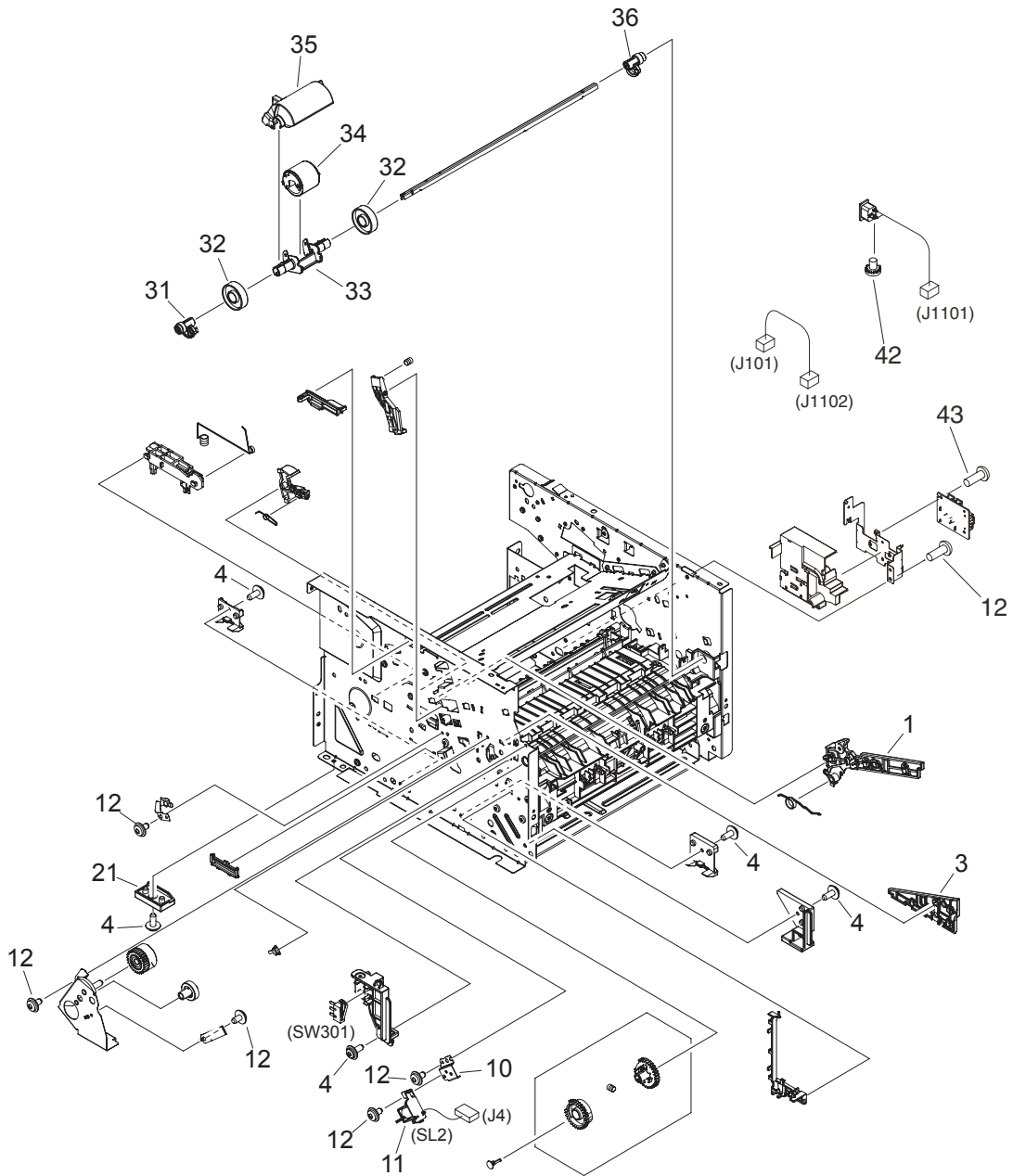

**Table 7-27 Internal components (3 of 4)**

| Ref | Description                             | Part number    | Qty |
|-----|---|----------------|-----|
| 1   | Screw, tapping truss head M4X10         | XB4-7401-005CN | 7   |
| 2   | Label, transfer guide open              | RC1-3796-000CN | 1   |
| 4   | Registration assembly                   | RM1-4244-000CN | 1   |
| 5   | Label, clear jam                        | RC2-2952-000CN | 1   |
| 6   | Label, fixing (fusing) pressure release | RC1-2953-000CN | 1   |
| 8   | Shutter link assembly                   | RM1-1321-000CN | 1   |
| 9   | Screw, RS M3X8                          | XA9-1504-000CN | 1   |
| 10  | Top-sensor assembly                     | RM1-1283-000CN | 1   |
| 12  | Screw, w/washer M4X12                   | XA9-1422-000CN | 1   |
| 13  | Screw, tap binding head M3X8            | XB4-7300-000CN | 2   |
| 13  | Screw, RS M3X6                          | XA9-1495-000CN | 2   |
| 15  | Paper-width sensor assembly             | RM1-4245-000CN | 1   |
| 20  | Screw, w/washer M3X8                    | XA9-1420-000CN | 1   |
| 28  | Roller, transfer                        | RM1-4279-000CN | 1   |

# Internal components (4 of 4)

Figure 7-22 Internal components (4 of 4)

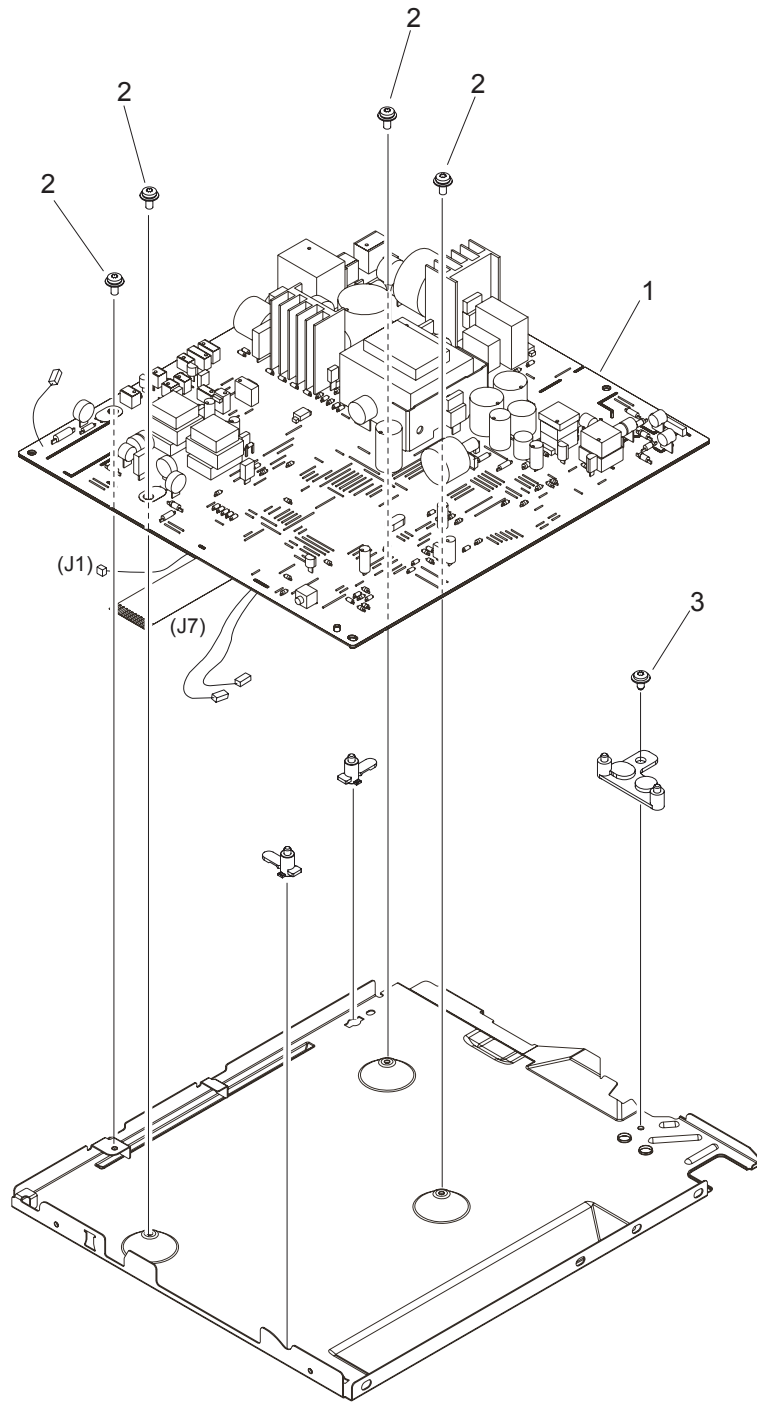

**Table 7-28 Internal components (4 of 4)**

| Ref | Description                   | Part number    | Qty |
|-----|-------------------------------|----------------|-----|
| 1   | Guide, cartridge left upper   | RC2-0425-000CN | 1   |
| 3   | Guide, cartridge left lower   | RC2-0339-000CN | 1   |
| 4   | Screw, RS M3X8                | XA9-1504-000CN | 6   |
| 10  | MP solenoid holder            | RC2-0334-000CN | 1   |
| 11  | Solenoid (SL2)                | RK2-1587-000CN | 1   |
| 12  | Screw, RS M3X6                | XA9-1495-000CN | 8   |
| 31  | MP left cam                   | RC2-0387-000CN | 1   |
| 32  | MP roller                     | RC1-0950-000CN | 2   |
| 33  | MP paper-pickup roller holder | RC2-0386-000CN | 1   |
| 34  | MP pickup roller              | RL1-1525-000CN | 1   |
| 35  | MP paper-pickup roller cover  | RC2-0420-000CN | 1   |
| 36  | MP right cam                  | RC2-0388-000CN | 1   |
| 42  | Screw, toothed washer M4X6    | XB2-7400-606CN | 1   |
| 43  | Screw, w/washer M3X8          | XA9-1420-000CN | 2   |

# Engine-controller assembly (ECU)

Figure 7-23 Engine-controller assembly

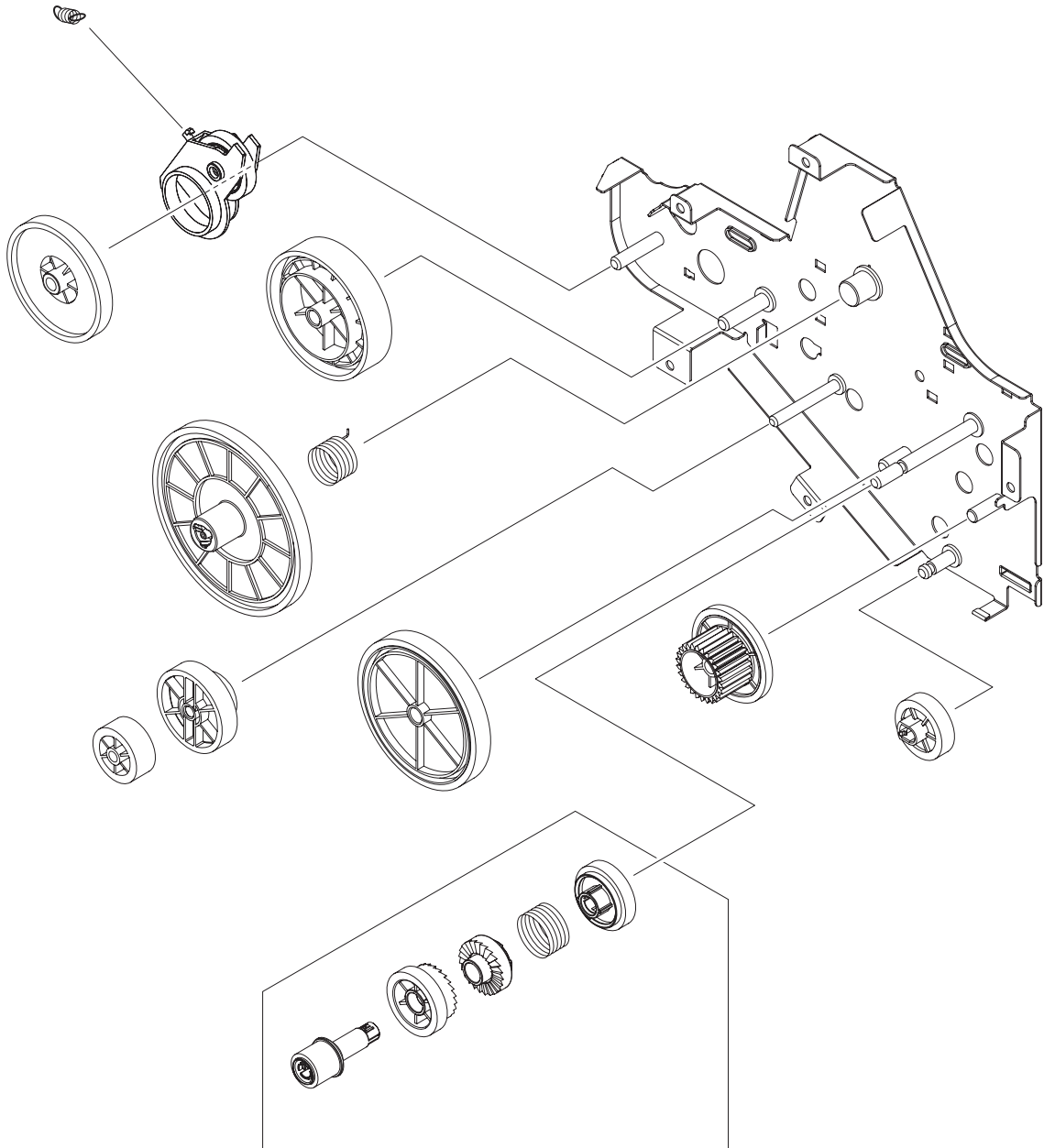

**Table 7-29 Engine-controller assembly**

| <b>Ref</b> | <b>Description</b>                   | <b>Part number</b> | <b>Qty</b> |
|------------|--------------------------------------|--------------------|------------|
| 1          | Engine-controller PCA (110 to 127 v) | RM1-4940-000CN     | 1          |
| 1          | Engine-controller PCA (220 to 240 v) | RM1-4941-000CN     | 1          |
| 2          | Screw, w/washer M3X8                 | XA9-1420-000CN     | 4          |
| 3          | Screw, RS M3X6                       | XA9-1495-000CN     | 1          |

# Main-drive assembly

Figure 7-24 Main-drive assembly

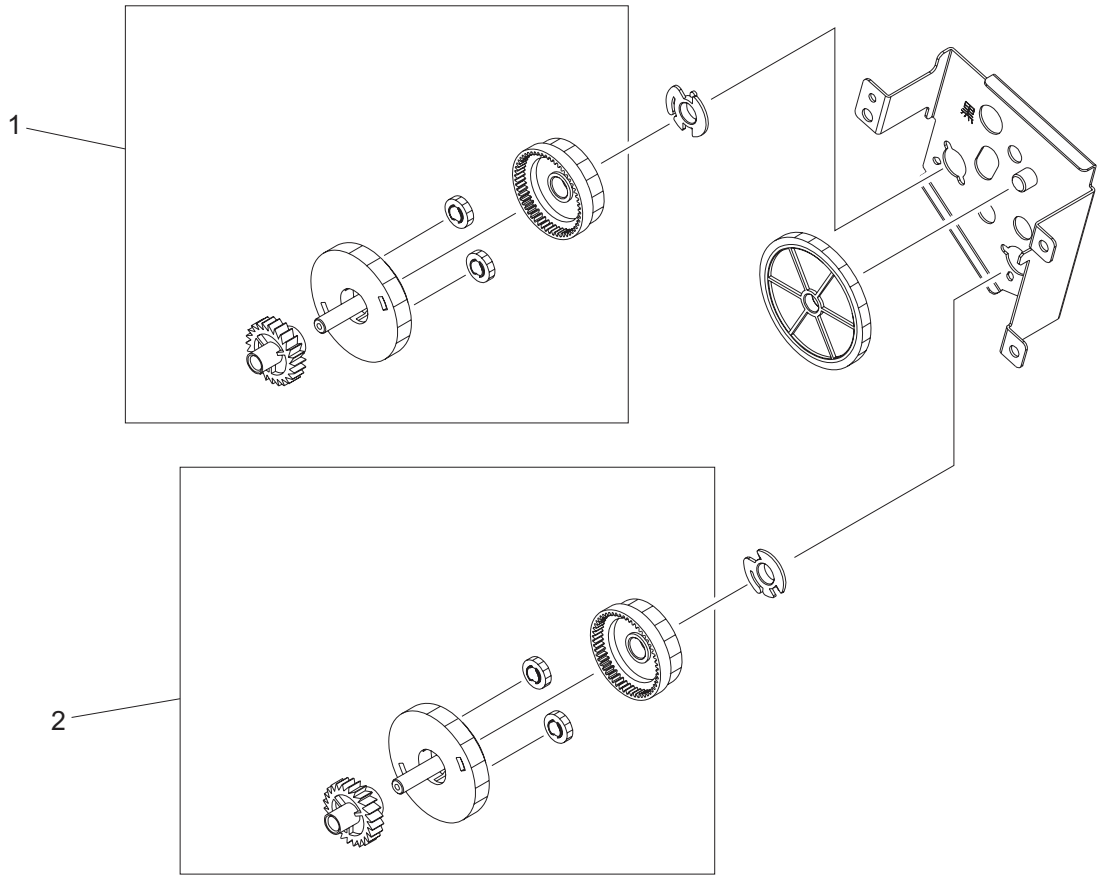

**Table 7-30 Main-drive assembly**

| Ref | Description         | Part number    | Qty |
|-----|---------------------|----------------|-----|
| all | Main-drive assembly | RM1-4253-000CN | 1   |

# Duplexing-drive assembly

Figure 7-25 Duplexing-drive assembly



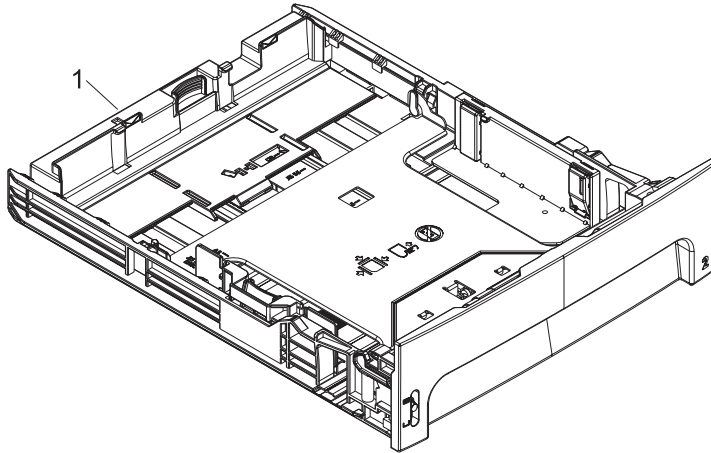

**Table 7-31 Duplexing-drive assembly**

| <b>Ref</b> | <b>Description</b>              | <b>Part number</b> | <b>Qty</b> |
|------------|---------------------------------|--------------------|------------|
| all        | Duplexing-drive assembly        | RM1-4255-000CN     | 1          |
| 1          | Normal-rotation drive assembly  | RM1-4256-000CN     | 1          |
| 2          | Reverse-rotation drive assembly | RM1-4257-000CN     | 1          |

## Tray 2 cassette and tray 3 cassette/feeder

Figure 7-26 Tray 2 cassette and tray 3 cassette/feeder



Tray 2 cassette

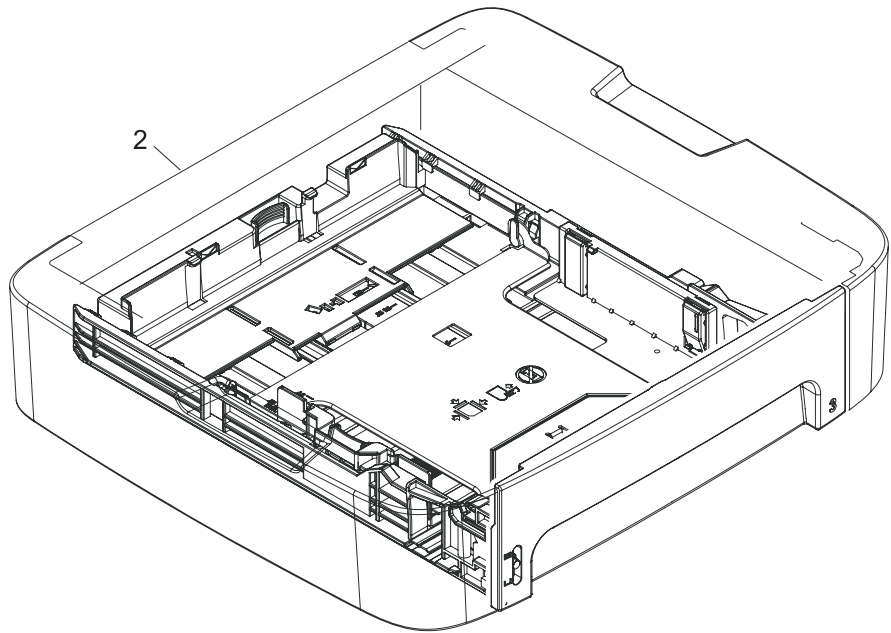

Tray 3 cassette/feeder

**Table 7-32 Tray 2 cassette and tray 3 cassette/feeder**

| Ref       | Description                                | Part number    | Qty |
|-----------|--|----------------|-----|
| 1         | Cassette, tray 2 (250-sheet)               | RM1-4251-000CN | 1   |
| 2         | Cassette/feeder, tray 3 (250-sheet)        | Q7556-67901    | 1   |
| Not shown | Separation pad, tray 2 and optional tray 3 | RM1-1292-000CN | 1   |

 **NOTE:** Paper trays are not serviceable. Replace the entire tray if needed.

# Duplexing assembly

Figure 7-27 Duplexing assembly

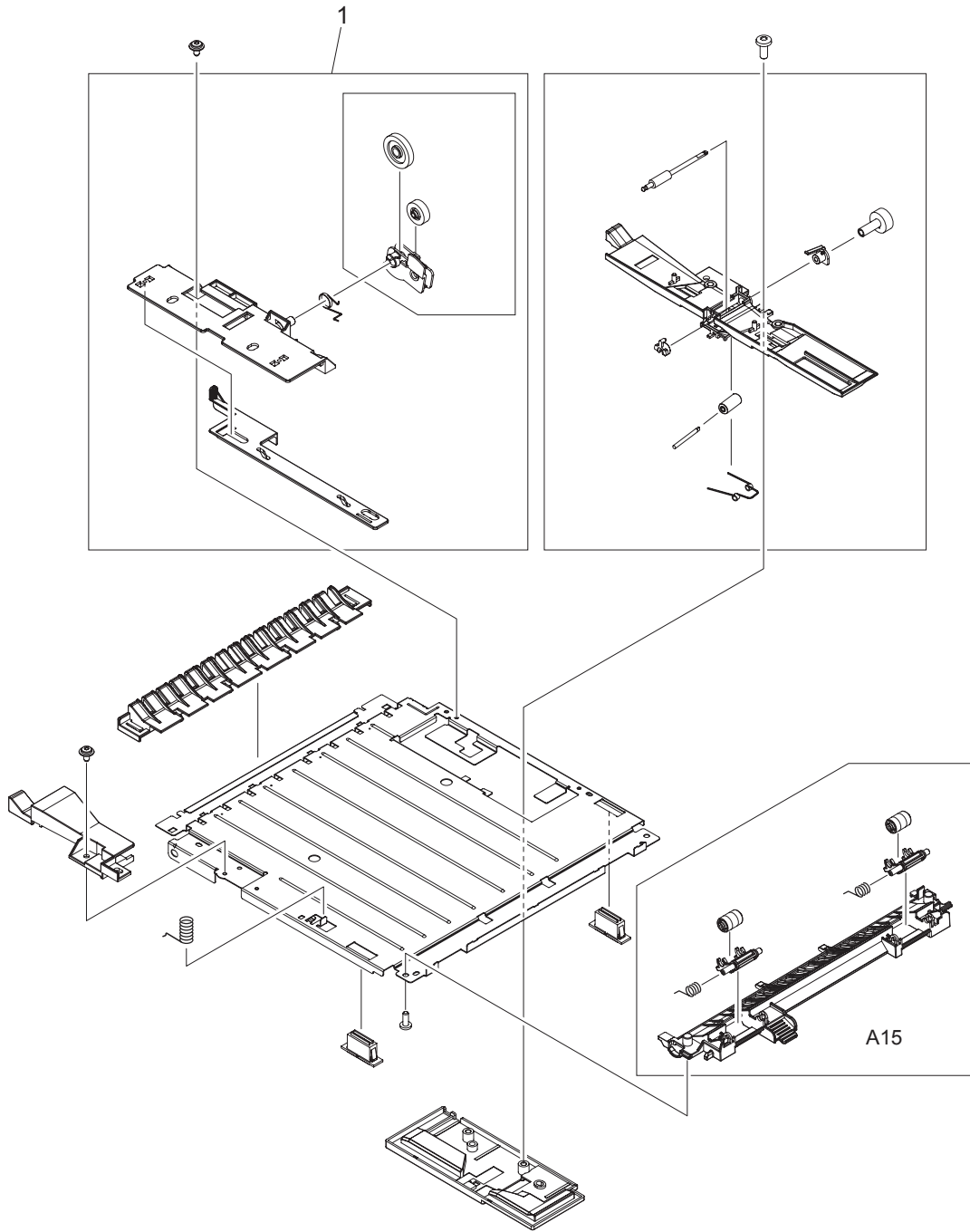
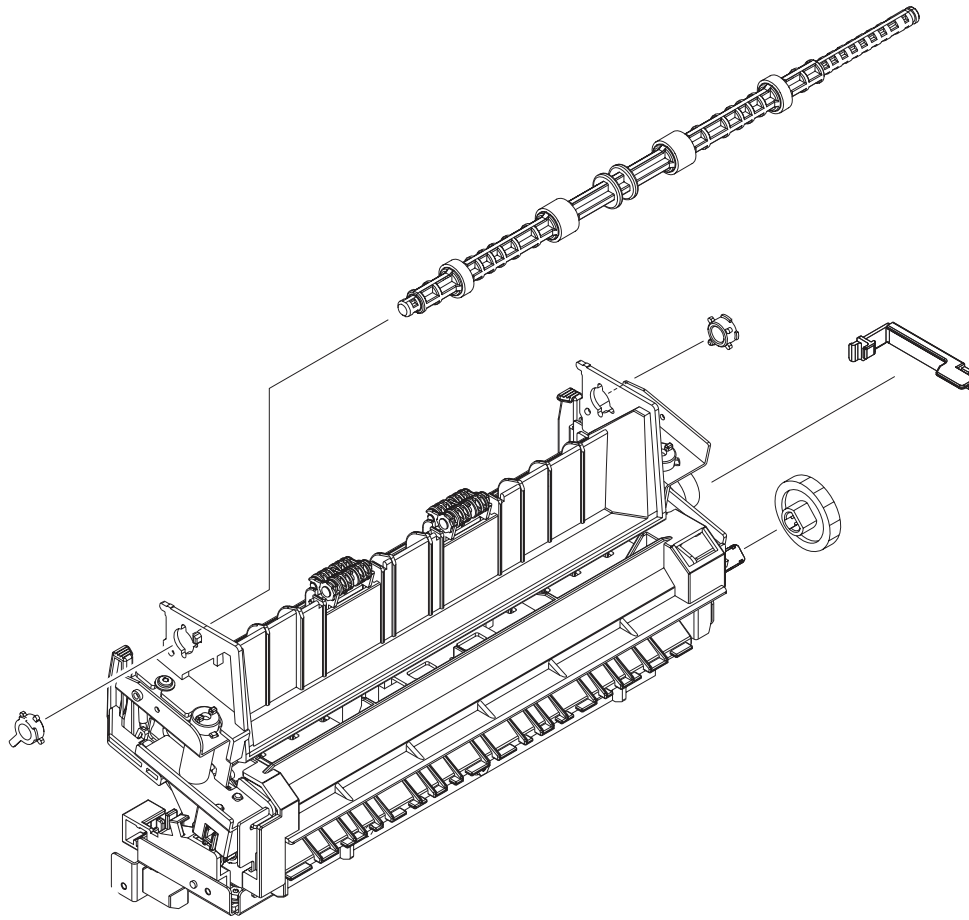

**Table 7-33 Duplexing assembly**

| <b>Ref</b> | <b>Description</b>   | <b>Part number</b> | <b>Qty</b> |
|------------|----------------------|--------------------|------------|
| all        | Duplexing assembly   | RM1-4258-000CN     | 1          |
| 1          | Size-change assembly | RM1-1318-000CN     | 1          |

# Fuser assembly

Figure 7-28 Fuser assembly



**Table 7-34 Fuser assembly**

| <b>Ref</b> | <b>Description</b>   | <b>Part number</b> | <b>Qty</b> |
|------------|----------------------|--------------------|------------|
| all        | Fuser (110 to 127 v) | RM1-4247-000CN     | 1          |
| all        | Fuser (220 to 240 v) | RM1-4248-000CN     | 1          |

# Alphabetical parts list

**Table 7-35 Alphabetical parts list**

| Description  | Part number  | Table and page   |
|--|--|--|
| ADF cleanout part  | C7309-40153  | <a href="#">ADF components on page 277</a>   |
| ADF cover replacement kit  | Q6500-67901  | <a href="#">ADF components on page 277</a>   |
| ADF flag replacement kit   | Q3948-67902  | <a href="#">ADF components on page 277</a>   |
| ADF hinge replacement kit  | Q3948-67905  | <a href="#">Scanner and ADF assemblies on page 273</a>                                 |
| ADF pickup roller assembly                                       | 5851-2559  | <a href="#">ADF components on page 277</a>   |
| ADF PKG FGI ASSY (automatic document feeder)                     | CB532-67903  | <a href="#">Scanner and ADF assemblies on page 273</a>                                 |
| ADF separation pad   | Q2665-60125  | <a href="#">ADF components on page 277</a>   |
| ADF window replacement kit                                       | Q6500-67904  | <a href="#">Scanner components on page 275</a>   |
| Arm, cam   | RC2-0405-000CN   | <a href="#">Internal components (2 of 4) on page 289</a>                               |
| Arm, tag   | RC2-0392-000CN   | <a href="#">Internal components (2 of 4) on page 289</a>                               |
| Bezel, control panel   | See <a href="#">Control-panel bezels on page 255</a> . | <a href="#">Scanner components on page 275</a>   |
| Bushing  | RC1-3665-000CN   | <a href="#">Internal components (1 of 4) on page 287</a>                               |
| Cartridge door assembly  | RM1-4711-000CN   | <a href="#">Cartridge door assembly on page 285</a>                                    |
| Cassette, tray 2 (250-sheet)                                     | RM1-4251-000CN   | <a href="#">Tray 2 cassette and tray 3 cassette/feeder on page 301</a>                 |
| Cassette/feeder, tray 3 (250-sheet)                              | Q7556-67901  | <a href="#">Tray 2 cassette and tray 3 cassette/feeder on page 301</a>                 |
| Control panel, Asian fax   | CB532-60102  | <a href="#">Scanner components on page 275</a>   |
| Control panel, Western fax                                       | CB532-60101  | <a href="#">Scanner components on page 275</a>   |
| Convenience stapler AC inlet cable HP LaserJet M2727nfs          | Q6501-60101  | <a href="#">Convenience stapler components (HP LaserJet M2727nfs only) on page 279</a> |
| Convenience stapler cassette (2-pack) HP LaserJet M2727nfs       | Q7432-67001  | <a href="#">Convenience stapler components (HP LaserJet M2727nfs only) on page 279</a> |
| Convenience stapler cover door HP LaserJet M2727nfs              | RC1-7523-000CN   | <a href="#">Convenience stapler components (HP LaserJet M2727nfs only) on page 279</a> |
| Convenience stapler mechanism HP LaserJet M2727nfs (replacement) | CB532-60105  | <a href="#">Convenience stapler components (HP LaserJet M2727nfs only) on page 279</a> |



**Table 7-35 Alphabetical parts list (continued)**

| Description   | Part number    | Table and page   |
|---|----------------|--|
| Convenience stapler power supply bracket and strap HP LaserJet M2727nfs | CB532-67902    | <a href="#">Convenience stapler components (HP LaserJet M2727nfs only) on page 279</a> |
| Convenience stapler power supply HP LaserJet M2727nfs                   | Q7429-60501    | <a href="#">Convenience stapler components (HP LaserJet M2727nfs only) on page 279</a> |
| Cover dummy (stapler plug; HP LaserJet M2727nf)                         | RC1-7523-000CN | <a href="#">External covers and panels on page 283</a>                                 |
| Cover front   | RC2-0330-000CN | <a href="#">External covers and panels on page 283</a>                                 |
| Cover left (with DIMM door)   | RC1-4707-000CN | <a href="#">External covers and panels on page 283</a>                                 |
| Cover right (with dummy stapler cover)                                  | RM1-4708-000CN | <a href="#">External covers and panels on page 283</a>                                 |
| Cover top   | RC2-2940-000CN | <a href="#">External covers and panels on page 283</a>                                 |
| Duplexing assembly  | RM1-4258-000CN | <a href="#">Duplexing assembly on page 303</a>   |
| Duplexing-drive assembly  | RM1-4255-000CN | <a href="#">Duplexing-drive assembly on page 299</a>                                   |
| Engine-controller PCA (110 to 127 v)                                    | RM1-4940-000CN | <a href="#">Engine-controller assembly on page 295</a>                                 |
| Engine-controller PCA (220 to 240 v)                                    | RM1-4941-000CN | <a href="#">Engine-controller assembly on page 295</a>                                 |
| Fan   | RK2-2082-000CN | <a href="#">Internal components (2 of 4) on page 289</a>                               |
| Fax card EMEA ROHS  | CC369-60001    | <a href="#">Formatter, Fax card, HP jewel, and nameplate on page 281</a>               |
| Fax card US/AP ROHS   | CC502-60001    | <a href="#">Formatter, Fax card, HP jewel, and nameplate on page 281</a>               |
| Fax card/Formatter FFC  | CB534-60117    | <a href="#">Formatter, Fax card, HP jewel, and nameplate on page 281</a>               |
| Flag, paper sensing   | RC1-3472-000CN | <a href="#">Internal components (1 of 4) on page 287</a>                               |
| Formatter PCA   | CC370-60001    | <a href="#">Formatter, Fax card, HP jewel, and nameplate on page 281</a>               |
| Fuser (110 to 127 v)  | RM1-4247-000CN | <a href="#">Fuser assembly on page 305</a>   |
| Fuser (220 to 240 v)  | RM1-4248-000CN | <a href="#">Fuser assembly on page 305</a>   |
| Gear, 19T   | RU5-0332-000CN | <a href="#">Internal components (1 of 4) on page 287</a>                               |
| Gear, 29T   | RU5-0331-000CN | <a href="#">Internal components (1 of 4) on page 287</a>                               |
| Guide, cartridge left lower   | RC2-0339-000CN | <a href="#">Internal components (4 of 4) on page 293</a>                               |

**Table 7-35 Alphabetical parts list (continued)**

| Description                             | Part number    | Table and page   |
|---|----------------|--|
| Guide, cartridge left upper             | RC2-0425-000CN | <a href="#">Internal components (4 of 4) on page 293</a>                 |
| Guide, cartridge right lower            | RC2-0346-000CN | <a href="#">Internal components (2 of 4) on page 289</a>                 |
| Guide, cartridge right upper            | RC1-0426-000CN | <a href="#">Internal components (2 of 4) on page 289</a>                 |
| Guide, DC cable 2                       | RC2-1569-000CN | <a href="#">Internal components (1 of 4) on page 287</a>                 |
| Holder, drawer connector                | RC2-0396-000CN | <a href="#">Internal components (2 of 4) on page 289</a>                 |
| Holder, fan                             | RC2-2946-000CN | <a href="#">Internal components (2 of 4) on page 289</a>                 |
| Inner cover                             | RM1-4712-000CN | <a href="#">Cartridge door assembly on page 285</a>                      |
| Input tray assembly HP LaserJet M2727   | Q6500-60119    | <a href="#">Scanner and ADF assemblies on page 273</a>                   |
| Jewel, HP                               | 7121-8285      | <a href="#">Formatter, Fax card, HP jewel, and nameplate on page 281</a> |
| Label, clear jam                        | RC2-2952-000CN | <a href="#">Internal components (3 of 4) on page 291</a>                 |
| Label, fixing (fusing) pressure release | RC1-2953-000CN | <a href="#">Internal components (3 of 4) on page 291</a>                 |
| Label, stapler prohibition              | RC1-3794-000CN | <a href="#">External covers and panels on page 283</a>                   |
| Label, transfer guide open              | RC1-3796-000CN | <a href="#">Internal components (3 of 4) on page 291</a>                 |
| Left bushing                            | RB2-2896-000CN | <a href="#">Internal components (1 of 4) on page 287</a>                 |
| Main-drive assembly                     | RM1-4253-000CN | <a href="#">Main-drive assembly on page 297</a>                          |
| Motor, DC                               | RK2-1567-000CN | <a href="#">Internal components (2 of 4) on page 289</a>                 |
| MP left cam                             | RC2-0387-000CN | <a href="#">Internal components (4 of 4) on page 293</a>                 |
| MP paper-pickup roller cover            | RC2-0420-000CN | <a href="#">Internal components (4 of 4) on page 293</a>                 |
| MP paper-pickup roller holder           | RC2-0386-000CN | <a href="#">Internal components (4 of 4) on page 293</a>                 |
| MP pickup roller                        | RL1-1525-000CN | <a href="#">Internal components (4 of 4) on page 293</a>                 |
| MP right cam                            | RC2-0388-000CN | <a href="#">Internal components (4 of 4) on page 293</a>                 |
| MP roller                               | RC1-0950-000CN | <a href="#">Internal components (4 of 4) on page 293</a>                 |

**Table 7-35 Alphabetical parts list (continued)**

| Description  | Part number    | Table and page   |
|--|----------------|--|
| MP separation pad (Tray 1)                               | RL1-1524-000CN | <a href="#">Internal components (1 of 4) on page 287</a>                 |
| MP solenoid holder                                       | RC2-0334-000CN | <a href="#">Internal components (4 of 4) on page 293</a>                 |
| Nameplate HP LaserJet M2727nf                            | CB532-00009    | <a href="#">Formatter, Fax card, HP jewel, and nameplate on page 281</a> |
| Nameplate HP LaserJet M2727nfs                           | CB532-00003    | <a href="#">Formatter, Fax card, HP jewel, and nameplate on page 281</a> |
| Normal-rotation drive assembly                           | RM1-4256-000CN | <a href="#">Duplexing-drive assembly on page 299</a>                     |
| Paper-feed guide assembly                                | RM1-4263-000CN | <a href="#">Internal components (1 of 4) on page 287</a>                 |
| Paper-pickup drive shaft                                 | RC1-3471-000CN | <a href="#">Internal components (1 of 4) on page 287</a>                 |
| Paper-pickup gear assembly                               | RM1-1301-000CN | <a href="#">Internal components (1 of 4) on page 287</a>                 |
| Paper-retaining assembly                                 | RM1-4265-000CN | <a href="#">Internal components (1 of 4) on page 287</a>                 |
| Paper-width sensor assembly                              | RM1-4245-000CN | <a href="#">Internal components (3 of 4) on page 291</a>                 |
| PCA, Asian character display control panel (with spacer) | CB532-67904    | <a href="#">Formatter, Fax card, HP jewel, and nameplate on page 281</a> |
| Rear cover assembly                                      | RM1-4270-000CN | <a href="#">External covers and panels on page 283</a>                   |
| Registration assembly                                    | RM1-4244-000CN | <a href="#">Internal components (3 of 4) on page 291</a>                 |
| Reverse-rotation drive assembly                          | RM1-4257-000CN | <a href="#">Duplexing-drive assembly on page 299</a>                     |
| Right bushing  | RB2-2895-000CN | <a href="#">Internal components (1 of 4) on page 287</a>                 |
| Roller, face down  | RL1-0527-000CN | <a href="#">Internal components (1 of 4) on page 287</a>                 |
| Roller, paper pickup                                     | RL1-0540-000CN | <a href="#">Internal components (1 of 4) on page 287</a>                 |
| Roller, paper-pickup idler                               | RC1-3470-000CN | <a href="#">Internal components (1 of 4) on page 287</a>                 |
| Roller, transfer   | RM1-4279-000CN | <a href="#">Internal components (3 of 4) on page 291</a>                 |
| Scanner assembly (laser/scanner)                         | RM1-4262-000CN | <a href="#">Internal components (2 of 4) on page 289</a>                 |
| Screw, RS M3X6   | XA9-1495-000CN | <a href="#">Internal components (1 of 4) on page 287</a>                 |
| Screw, RS M3X6   | XA9-1495-000CN | <a href="#">Internal components (2 of 4) on page 289</a>                 |

**Table 7-35 Alphabetical parts list (continued)**

| Description                                | Part number    | Table and page   |
|--|----------------|--|
| Screw, RS M3X6                             | XA9-1495-000CN | <a href="#">Internal components (3 of 4) on page 291</a>               |
| Screw, RS M3X6                             | XA9-1495-000CN | <a href="#">Internal components (4 of 4) on page 293</a>               |
| Screw, RS M3X6                             | XA9-1495-000CN | <a href="#">Engine-controller assembly on page 295</a>                 |
| Screw, RS M3X8                             | XA9-1504-000CN | <a href="#">Internal components (2 of 4) on page 289</a>               |
| Screw, RS M3X8                             | XA9-1561-000CN | <a href="#">Internal components (2 of 4) on page 289</a>               |
| Screw, RS M3X8                             | XA9-1504-000CN | <a href="#">Internal components (3 of 4) on page 291</a>               |
| Screw, RS M3X8                             | XA9-1504-000CN | <a href="#">Internal components (4 of 4) on page 293</a>               |
| Screw, tap binding head M3X8               | XB4-7300-000CN | <a href="#">Internal components (3 of 4) on page 291</a>               |
| Screw, tap M3X6                            | XA9-1503-000CN | <a href="#">Internal components (1 of 4) on page 287</a>               |
| Screw, tap M3X6                            | XA9-1503-000CN | <a href="#">Internal components (2 of 4) on page 289</a>               |
| Screw, tapping binding head M3X8           | XB4-7300-000CN | <a href="#">Internal components (1 of 4) on page 287</a>               |
| Screw, tapping truss                       | XB4-7401-000CN | <a href="#">Cartridge door assembly on page 285</a>                    |
| Screw, tapping truss head M4X10            | XB4-7401-000CN | <a href="#">Internal components (1 of 4) on page 287</a>               |
| Screw, tapping truss head M4X10            | XB4-7401-005CN | <a href="#">Internal components (3 of 4) on page 291</a>               |
| Screw, toothed washer M4X6                 | XB2-7400-606CN | <a href="#">Internal components (4 of 4) on page 293</a>               |
| Screw, TP M3X8                             | XA9-1648-000CN | <a href="#">Internal components (2 of 4) on page 289</a>               |
| Screw, w/washer M3X8                       | XA9-1420-000CN | <a href="#">Internal components (3 of 4) on page 291</a>               |
| Screw, w/washer M3X8                       | XA9-1420-000CN | <a href="#">Internal components (4 of 4) on page 293</a>               |
| Screw, w/washer M3X8                       | XA9-1420-000CN | <a href="#">Engine-controller assembly on page 295</a>                 |
| Screw, w/washer M4X12                      | XA9-1422-000CN | <a href="#">Internal components (3 of 4) on page 291</a>               |
| Separation pad base                        | RC2-0419-000CN | <a href="#">Internal components (1 of 4) on page 287</a>               |
| Separation pad, tray 2 and optional tray 3 | RM1-1292-000CN | <a href="#">Tray 2 cassette and tray 3 cassette/feeder on page 301</a> |

**Table 7-35 Alphabetical parts list (continued)**

| <b>Description</b>                          | <b>Part number</b> | <b>Table and page</b>                                    |
|---|--------------------|--|
| Shutter link assembly                       | RM1-1321-000CN     | <a href="#">Internal components (3 of 4) on page 291</a> |
| Size-change assembly                        | RM1-1318-000CN     | <a href="#">Duplexing assembly on page 303</a>           |
| Solenoid (SL1)                              | RK2-0424-000CN     | <a href="#">Internal components (2 of 4) on page 289</a> |
| Solenoid (SL2)                              | RK2-1587-000CN     | <a href="#">Internal components (4 of 4) on page 293</a> |
| Solenoid (SL3)                              | RK2-0910-000CN     | <a href="#">Internal components (2 of 4) on page 289</a> |
| Speaker assembly                            | RM1-4943-000CN     | <a href="#">Internal components (1 of 4) on page 287</a> |
| Spring, compression                         | RU5-2894-000CN     | <a href="#">Internal components (1 of 4) on page 287</a> |
| Spring, compression                         | RU5-2323-000CN     | <a href="#">Internal components (1 of 4) on page 287</a> |
| SSA PKG FGI ASSY (scanner flatbed assembly) | CB532-67905        | <a href="#">Scanner and ADF assemblies on page 273</a>   |
| Top-sensor assembly                         | RM1-1283-000CN     | <a href="#">Internal components (3 of 4) on page 291</a> |

# Numerical parts list

**Table 7-36 Numerical parts list**

| Part number | Description   | Table and page   |
|-------------|---|--|
| 5851-2559   | ADF pickup roller assembly  | <a href="#">ADF components on page 277</a>   |
| 7121-8285   | Jewel, HP   | <a href="#">Formatter, Fax card, HP jewel, and nameplate on page 281</a>               |
| C7309-40153 | ADF cleanout part   | <a href="#">ADF components on page 277</a>   |
| CB532-00003 | Nameplate HP LaserJet M2727nfs  | <a href="#">Formatter, Fax card, HP jewel, and nameplate on page 281</a>               |
| CB532-00009 | Nameplate HP LaserJet M2727nf   | <a href="#">Formatter, Fax card, HP jewel, and nameplate on page 281</a>               |
| CB532-60101 | Control panel, Western fax  | <a href="#">Scanner components on page 275</a>   |
| CB532-60102 | Control panel, Asian fax  | <a href="#">Scanner components on page 275</a>   |
| CB532-60105 | Convenience stapler mechanism HP LaserJet M2727nfs (replacement)        | <a href="#">Convenience stapler components (HP LaserJet M2727nfs only) on page 279</a> |
| CB532-67902 | Convenience stapler power supply bracket and strap HP LaserJet M2727nfs | <a href="#">Convenience stapler components (HP LaserJet M2727nfs only) on page 279</a> |
| CB532-67903 | ADF PKG FGI ASSY (automatic document feeder)                            | <a href="#">Scanner and ADF assemblies on page 273</a>                                 |
| CB532-67904 | PCA, Asian character display control panel (with spacer)                | <a href="#">Formatter, Fax card, HP jewel, and nameplate on page 281</a>               |
| CB532-67905 | SSA PKG FGI ASSY (scanner flatbed assembly)                             | <a href="#">Scanner and ADF assemblies on page 273</a>                                 |
| CB534-60117 | Fax card/Formatter FFC  | <a href="#">Formatter, Fax card, HP jewel, and nameplate on page 281</a>               |
| CC369-60001 | Fax card EMEA ROHS  | <a href="#">Formatter, Fax card, HP jewel, and nameplate on page 281</a>               |
| CC370-60001 | Formatter PCA   | <a href="#">Formatter, Fax card, HP jewel, and nameplate on page 281</a>               |
| CC502-60001 | Fax card US/AP ROHS   | <a href="#">Formatter, Fax card, HP jewel, and nameplate on page 281</a>               |
| Q2665-60125 | ADF separation pad  | <a href="#">ADF components on page 277</a>   |
| Q3948-67902 | ADF flag replacement kit  | <a href="#">ADF components on page 277</a>   |
| Q3948-67905 | ADF hinge replacement kit   | <a href="#">Scanner and ADF assemblies on page 273</a>                                 |
| Q6500-60119 | Input tray assembly HP LaserJet M2727                                   | <a href="#">Scanner and ADF assemblies on page 273</a>                                 |
| Q6500-67901 | ADF cover replacement kit   | <a href="#">ADF components on page 277</a>   |
| Q6500-67904 | ADF window replacement kit  | <a href="#">Scanner components on page 275</a>   |

**Table 7-36 Numerical parts list (continued)**

| <b>Part number</b> | <b>Description</b>   | <b>Table and page</b>  |
|--------------------|--|--|
| Q6501-60101        | Convenience stapler AC inlet cable HP LaserJet M2727nfs    | <a href="#">Convenience stapler components (HP LaserJet M2727nfs only) on page 279</a> |
| Q7429-60501        | Convenience stapler power supply HP LaserJet M2727nfs      | <a href="#">Convenience stapler components (HP LaserJet M2727nfs only) on page 279</a> |
| Q7432-67001        | Convenience stapler cassette (2-pack) HP LaserJet M2727nfs | <a href="#">Convenience stapler components (HP LaserJet M2727nfs only) on page 279</a> |
| Q7556-67901        | Cassette/feeder, tray 3 (250-sheet)                        | <a href="#">Tray 2 cassette and tray 3 cassette/feeder on page 301</a>                 |
| RB2-2895-000CN     | Right bushing  | <a href="#">Internal components (1 of 4) on page 287</a>                               |
| RB2-2896-000CN     | Left bushing   | <a href="#">Internal components (1 of 4) on page 287</a>                               |
| RC1-0426-000CN     | Guide, cartridge right upper                               | <a href="#">Internal components (2 of 4) on page 289</a>                               |
| RC1-0950-000CN     | MP roller  | <a href="#">Internal components (4 of 4) on page 293</a>                               |
| RC1-2953-000CN     | Label, fixing (fusing) pressure release                    | <a href="#">Internal components (3 of 4) on page 291</a>                               |
| RC1-3470-000CN     | Roller, paper-pickup idler                                 | <a href="#">Internal components (1 of 4) on page 287</a>                               |
| RC1-3471-000CN     | Paper-pickup drive shaft                                   | <a href="#">Internal components (1 of 4) on page 287</a>                               |
| RC1-3472-000CN     | Flag, paper sensing  | <a href="#">Internal components (1 of 4) on page 287</a>                               |
| RC1-3665-000CN     | Bushing  | <a href="#">Internal components (1 of 4) on page 287</a>                               |
| RC1-3794-000CN     | Label, stapler prohibition                                 | <a href="#">External covers and panels on page 283</a>                                 |
| RC1-3796-000CN     | Label, transfer guide open                                 | <a href="#">Internal components (3 of 4) on page 291</a>                               |
| RC1-4707-000CN     | Cover left (with DIMM door)                                | <a href="#">External covers and panels on page 283</a>                                 |
| RC1-7523-000CN     | Convenience stapler cover door HP LaserJet M2727nfs        | <a href="#">Convenience stapler components (HP LaserJet M2727nfs only) on page 279</a> |
| RC1-7523-000CN     | Cover dummy (stapler plug; HP LaserJet M2727nf)            | <a href="#">External covers and panels on page 283</a>                                 |
| RC2-0330-000CN     | Cover front  | <a href="#">External covers and panels on page 283</a>                                 |
| RC2-0334-000CN     | MP solenoid holder   | <a href="#">Internal components (4 of 4) on page 293</a>                               |
| RC2-0339-000CN     | Guide, cartridge left lower                                | <a href="#">Internal components (4 of 4) on page 293</a>                               |

**Table 7-36 Numerical parts list (continued)**

| <b>Part number</b> | <b>Description</b>            | <b>Table and page</b>                                    |
|--------------------|-------------------------------|--|
| RC2-0346-000CN     | Guide, cartridge right lower  | <a href="#">Internal components (2 of 4) on page 289</a> |
| RC2-0386-000CN     | MP paper-pickup roller holder | <a href="#">Internal components (4 of 4) on page 293</a> |
| RC2-0387-000CN     | MP left cam                   | <a href="#">Internal components (4 of 4) on page 293</a> |
| RC2-0388-000CN     | MP right cam                  | <a href="#">Internal components (4 of 4) on page 293</a> |
| RC2-0392-000CN     | Arm, tag                      | <a href="#">Internal components (2 of 4) on page 289</a> |
| RC2-0396-000CN     | Holder, drawer connector      | <a href="#">Internal components (2 of 4) on page 289</a> |
| RC2-0405-000CN     | Arm, cam                      | <a href="#">Internal components (2 of 4) on page 289</a> |
| RC2-0419-000CN     | Separation pad base           | <a href="#">Internal components (1 of 4) on page 287</a> |
| RC2-0420-000CN     | MP paper-pickup roller cover  | <a href="#">Internal components (4 of 4) on page 293</a> |
| RC2-0425-000CN     | Guide, cartridge left upper   | <a href="#">Internal components (4 of 4) on page 293</a> |
| RC2-1569-000CN     | Guide, DC cable 2             | <a href="#">Internal components (1 of 4) on page 287</a> |
| RC2-2940-000CN     | Cover top                     | <a href="#">External covers and panels on page 283</a>   |
| RC2-2946-000CN     | Holder, fan                   | <a href="#">Internal components (2 of 4) on page 289</a> |
| RC2-2952-000CN     | Label, clear jam              | <a href="#">Internal components (3 of 4) on page 291</a> |
| RK2-0424-000CN     | Solenoid (SL1)                | <a href="#">Internal components (2 of 4) on page 289</a> |
| RK2-0910-000CN     | Solenoid (SL3)                | <a href="#">Internal components (2 of 4) on page 289</a> |
| RK2-1567-000CN     | Motor, DC                     | <a href="#">Internal components (2 of 4) on page 289</a> |
| RK2-1587-000CN     | Solenoid (SL2)                | <a href="#">Internal components (4 of 4) on page 293</a> |
| RK2-2082-000CN     | Fan                           | <a href="#">Internal components (2 of 4) on page 289</a> |
| RL1-0527-000CN     | Roller, face down             | <a href="#">Internal components (1 of 4) on page 287</a> |
| RL1-0540-000CN     | Roller, paper pickup          | <a href="#">Internal components (1 of 4) on page 287</a> |
| RL1-1524-000CN     | MP separation pad (Tray 1)    | <a href="#">Internal components (1 of 4) on page 287</a> |



**Table 7-36 Numerical parts list (continued)**

| <b>Part number</b> | <b>Description</b>                         | <b>Table and page</b>  |
|--------------------|--|--|
| RL1-1525-000CN     | MP pickup roller                           | <a href="#">Internal components (4 of 4) on page 293</a>               |
| RM1-1283-000CN     | Top-sensor assembly                        | <a href="#">Internal components (3 of 4) on page 291</a>               |
| RM1-1292-000CN     | Separation pad, tray 2 and optional tray 3 | <a href="#">Tray 2 cassette and tray 3 cassette/feeder on page 301</a> |
| RM1-1301-000CN     | Paper-pickup gear assembly                 | <a href="#">Internal components (1 of 4) on page 287</a>               |
| RM1-1318-000CN     | Size-change assembly                       | <a href="#">Duplexing assembly on page 303</a>                         |
| RM1-1321-000CN     | Shutter link assembly                      | <a href="#">Internal components (3 of 4) on page 291</a>               |
| RM1-4244-000CN     | Registration assembly                      | <a href="#">Internal components (3 of 4) on page 291</a>               |
| RM1-4245-000CN     | Paper-width sensor assembly                | <a href="#">Internal components (3 of 4) on page 291</a>               |
| RM1-4247-000CN     | Fuser (110 to 127 v)                       | <a href="#">Fuser assembly on page 305</a>                             |
| RM1-4248-000CN     | Fuser (220 to 240 v)                       | <a href="#">Fuser assembly on page 305</a>                             |
| RM1-4251-000CN     | Cassette, tray 2 (250-sheet)               | <a href="#">Tray 2 cassette and tray 3 cassette/feeder on page 301</a> |
| RM1-4253-000CN     | Main-drive assembly                        | <a href="#">Main-drive assembly on page 297</a>                        |
| RM1-4255-000CN     | Duplexing-drive assembly                   | <a href="#">Duplexing-drive assembly on page 299</a>                   |
| RM1-4256-000CN     | Normal-rotation drive assembly             | <a href="#">Duplexing-drive assembly on page 299</a>                   |
| RM1-4257-000CN     | Reverse-rotation drive assembly            | <a href="#">Duplexing-drive assembly on page 299</a>                   |
| RM1-4258-000CN     | Duplexing assembly                         | <a href="#">Duplexing assembly on page 303</a>                         |
| RM1-4262-000CN     | Scanner assembly (laser/scanner)           | <a href="#">Internal components (2 of 4) on page 289</a>               |
| RM1-4263-000CN     | Paper-feed guide assembly                  | <a href="#">Internal components (1 of 4) on page 287</a>               |
| RM1-4265-000CN     | Paper-retaining assembly                   | <a href="#">Internal components (1 of 4) on page 287</a>               |
| RM1-4270-000CN     | Rear cover assembly                        | <a href="#">External covers and panels on page 283</a>                 |
| RM1-4279-000CN     | Roller, transfer                           | <a href="#">Internal components (3 of 4) on page 291</a>               |
| RM1-4708-000CN     | Cover right (with dummy stapler cover)     | <a href="#">External covers and panels on page 283</a>                 |
| RM1-4711-000CN     | Cartridge door assembly                    | <a href="#">Cartridge door assembly on page 285</a>                    |

**Table 7-36 Numerical parts list (continued)**

| Part number  | Description                          | Table and page   |
|--|--------------------------------------|--|
| RM1-4712-000CN   | Inner cover                          | <a href="#">Cartridge door assembly on page 285</a>      |
| RM1-4940-000CN   | Engine-controller PCA (110 to 127 v) | <a href="#">Engine-controller assembly on page 295</a>   |
| RM1-4941-000CN   | Engine-controller PCA (220 to 240 v) | <a href="#">Engine-controller assembly on page 295</a>   |
| RM1-4943-000CN   | Speaker assembly                     | <a href="#">Internal components (1 of 4) on page 287</a> |
| RU5-0331-000CN   | Gear, 29T                            | <a href="#">Internal components (1 of 4) on page 287</a> |
| RU5-0332-000CN   | Gear, 19T                            | <a href="#">Internal components (1 of 4) on page 287</a> |
| RU5-2323-000CN   | Spring, compression                  | <a href="#">Internal components (1 of 4) on page 287</a> |
| RU5-2894-000CN   | Spring, compression                  | <a href="#">Internal components (1 of 4) on page 287</a> |
| See <a href="#">Control-panel bezels on page 255</a> . | Bezel, control panel                 | <a href="#">Scanner components on page 275</a>           |
| XA9-1420-000CN   | Screw, w/washer M3X8                 | <a href="#">Internal components (3 of 4) on page 291</a> |
| XA9-1420-000CN   | Screw, w/washer M3X8                 | <a href="#">Internal components (4 of 4) on page 293</a> |
| XA9-1420-000CN   | Screw, w/washer M3X8                 | <a href="#">Engine-controller assembly on page 295</a>   |
| XA9-1422-000CN   | Screw, w/washer M4X12                | <a href="#">Internal components (3 of 4) on page 291</a> |
| XA9-1495-000CN   | Screw, RS M3X6                       | <a href="#">Internal components (1 of 4) on page 287</a> |
| XA9-1495-000CN   | Screw, RS M3X6                       | <a href="#">Internal components (2 of 4) on page 289</a> |
| XA9-1495-000CN   | Screw, RS M3X6                       | <a href="#">Internal components (3 of 4) on page 291</a> |
| XA9-1495-000CN   | Screw, RS M3X6                       | <a href="#">Internal components (4 of 4) on page 293</a> |
| XA9-1495-000CN   | Screw, RS M3X6                       | <a href="#">Engine-controller assembly on page 295</a>   |
| XA9-1503-000CN   | Screw, tap M3X6                      | <a href="#">Internal components (1 of 4) on page 287</a> |
| XA9-1503-000CN   | Screw, tap M3X6                      | <a href="#">Internal components (2 of 4) on page 289</a> |
| XA9-1504-000CN   | Screw, RS M3X8                       | <a href="#">Internal components (2 of 4) on page 289</a> |
| XA9-1504-000CN   | Screw, RS M3X8                       | <a href="#">Internal components (3 of 4) on page 291</a> |

**Table 7-36 Numerical parts list (continued)**

| <b>Part number</b> | <b>Description</b>               | <b>Table and page</b>                                    |
|--------------------|----------------------------------|--|
| XA9-1504-000CN     | Screw, RS M3X8                   | <a href="#">Internal components (4 of 4) on page 293</a> |
| XA9-1561-000CN     | Screw, RS M3X8                   | <a href="#">Internal components (2 of 4) on page 289</a> |
| XA9-1648-000CN     | Screw, TP M3X8                   | <a href="#">Internal components (2 of 4) on page 289</a> |
| XB2-7400-606CN     | Screw, toothed washer M4X6       | <a href="#">Internal components (4 of 4) on page 293</a> |
| XB4-7300-000CN     | Screw, tapping binding head M3X8 | <a href="#">Internal components (1 of 4) on page 287</a> |
| XB4-7300-000CN     | Screw, tap binding head M3X8     | <a href="#">Internal components (3 of 4) on page 291</a> |
| XB4-7401-000CN     | Screw, tapping truss             | <a href="#">Cartridge door assembly on page 285</a>      |
| XB4-7401-000CN     | Screw, tapping truss head M4X10  | <a href="#">Internal components (1 of 4) on page 287</a> |
| XB4-7401-005CN     | Screw, tapping truss head M4X10  | <a href="#">Internal components (3 of 4) on page 291</a> |



---

# A Service and support

## Hewlett-Packard limited warranty statement

HP PRODUCT

HP LaserJet M2727nf and M2727nfs

DURATION OF LIMITED WARRANTY

One-year limited warranty

HP warrants to you, the end-user customer, that HP hardware and accessories will be free from defects in materials and workmanship after the date of purchase, for the period specified above. If HP receives notice of such defects during the warranty period, HP will, at its option, either repair or replace products which prove to be defective. Replacement products may be either new or equivalent in performance to new.

HP warrants to you that HP software will not fail to execute its programming instructions after the date of purchase, for the period specified above, due to defects in material and workmanship when properly installed and used. If HP receives notice of such defects during the warranty period, HP will replace software which does not execute its programming instructions due to such defects.

HP does not warrant that the operation of HP products will be uninterrupted or error free. If HP is unable, within a reasonable time, to repair or replace any product to a condition as warranted, you will be entitled to a refund of the purchase price upon prompt return of the product.

HP products may contain remanufactured parts equivalent to new in performance or may have been subject to incidental use.

Warranty does not apply to defects resulting from (a) improper or inadequate maintenance or calibration, (b) software, interfacing, parts or supplies not supplied by HP, (c) unauthorized modification or misuse, (d) operation outside of the published environmental specifications for the product, or (e) improper site preparation or maintenance.

TO THE EXTENT ALLOWED BY LOCAL LAW, THE ABOVE WARRANTIES ARE EXCLUSIVE AND NO OTHER WARRANTY OR CONDITION, WHETHER WRITTEN OR ORAL, IS EXPRESSED OR IMPLIED AND HP SPECIFICALLY DISCLAIMS ANY IMPLIED WARRANTIES OR CONDITIONS OF MERCHANTABILITY, SATISFACTORY QUALITY, AND FITNESS FOR A PARTICULAR PURPOSE. Some countries/regions, states or provinces do not allow limitations on the duration of an implied warranty, so the above limitation or exclusion might not apply to you. This warranty gives you specific legal rights and you might also have other rights that vary from country/region to country/region, state to state, or province to province. HP's limited warranty is valid in any country/region or locality where HP has a support presence for this product and where HP has marketed this product. The level of warranty service you receive may vary according to local standards. HP will not alter form, fit or function of the product to make it operate in a country/region for which it was never intended to function for legal or regulatory reasons.

TO THE EXTENT ALLOWED BY LOCAL LAW, THE REMEDIES IN THIS WARRANTY STATEMENT ARE YOUR SOLE AND EXCLUSIVE REMEDIES. EXCEPT AS INDICATED ABOVE, IN NO EVENT WILL HP OR ITS SUPPLIERS BE LIABLE FOR LOSS OF DATA OR FOR DIRECT, SPECIAL, INCIDENTAL, CONSEQUENTIAL

(INCLUDING LOST PROFIT OR DATA), OR OTHER DAMAGE, WHETHER BASED IN CONTRACT, TORT, OR OTHERWISE. Some countries/regions, states or provinces do not allow the exclusion or limitation of incidental or consequential damages, so the above limitation or exclusion may not apply to you.

THE WARRANTY TERMS CONTAINED IN THIS STATEMENT, EXCEPT TO THE EXTENT LAWFULLY PERMITTED, DO NOT EXCLUDE, RESTRICT OR MODIFY AND ARE IN ADDITION TO THE MANDATORY STATUTORY RIGHTS APPLICABLE TO THE SALE OF THIS PRODUCT TO YOU.

## Print cartridge limited warranty statement

This HP product is warranted to be free from defects in materials and workmanship.

This warranty does not apply to products that (a) have been refilled, refurbished, remanufactured or tampered with in any way, (b) experience problems resulting from misuse, improper storage, or operation outside of the published environmental specifications for the device product or (c) exhibit wear from ordinary use.

To obtain warranty service, please return the product to place of purchase (with a written description of the problem and print samples) or contact HP customer support. At HP's option, HP will either replace products that prove to be defective or refund your purchase price.

TO THE EXTENT ALLOWED BY LOCAL LAW, THE ABOVE WARRANTY IS EXCLUSIVE AND NO OTHER WARRANTY OR CONDITION, WHETHER WRITTEN OR ORAL, IS EXPRESSED OR IMPLIED AND HP SPECIFICALLY DISCLAIMS ANY IMPLIED WARRANTIES OR CONDITIONS OF MERCHANTABILITY, SATISFACTORY QUALITY, AND FITNESS FOR A PARTICULAR PURPOSE.

TO THE EXTENT ALLOWED BY LOCAL LAW, IN NO EVENT WILL HP OR ITS SUPPLIERS BE LIABLE FOR DIRECT, SPECIAL, INCIDENTAL, CONSEQUENTIAL (INCLUDING LOST PROFIT OR DATA), OR OTHER DAMAGE, WHETHER BASED IN CONTRACT, TORT, OR OTHERWISE.

THE WARRANTY TERMS CONTAINED IN THIS STATEMENT, EXCEPT TO THE EXTENT LAWFULLY PERMITTED, DO NOT EXCLUDE, RESTRICT OR MODIFY AND ARE IN ADDITION TO THE MANDATORY STATUTORY RIGHTS APPLICABLE TO THE SALE OF THIS PRODUCT TO YOU.





---

# B Specifications

This section contains the following information about the product:

- [Physical specifications](#)
- [Electrical specifications](#)
- [Power consumption](#)
- [Environmental specifications](#)
- [Acoustic emissions](#)

## Physical specifications

**Table B-1 Physical specifications**

| Product              | Height               | Depth                | Width                | Weight            |
|----------------------|----------------------|----------------------|----------------------|-------------------|
| HP LaserJet M2727nf  | 690 mm (27.2 inches) | 650 mm (25.6 inches) | 500 mm (19.7 inches) | 17.2 kg (37.8 lb) |
| HP LaserJet M2727nfs | 780 mm (30.7 inches) | 650 mm (25.6 inches) | 500 mm (19.7 inches) | 20.5 kg (44.9 lb) |

## Electrical specifications

**CAUTION:** Power requirements are based on the country/region where the product is sold. Do not convert operating voltages. This will damage the product and void the product warranty.

**Table B-2 Electrical specifications**

| Item               | 110-volt models        | 230-volt models        |
|--------------------|------------------------|------------------------|
| Power requirements | 110 to 127 V (+/- 10%) | 220 to 240 V (+/- 10%) |
|                    | 50 / 60 Hz (+/- 2 Hz)  | 50 / 60 Hz (+/- 2 Hz)  |
| Rated current      | 4.9 A                  | 2.9 A                  |

## Power consumption

**Table B-3 Power consumption (average, in watts)<sup>1, 5</sup>**

| Product model        | Printing <sup>2</sup> | Copying <sup>2</sup> | Ready/Sleep <sup>3, 4</sup> | Off <sup>2</sup> |
|----------------------|-----------------------|----------------------|-----------------------------|------------------|
| HP LaserJet M2727nf  | 410 W                 | 410 W                | 13 W                        | <0.1 W           |
| HP LaserJet M2727nfs | 410 W                 | 410 W                | 13 W                        | <0.1 W           |

<sup>1</sup> Values are based on preliminary data. See [www.hp.com/support/LJM2727](http://www.hp.com/support/LJM2727) for current information.

<sup>2</sup> Power reported is highest values measured using all standard voltages.

<sup>3</sup> Instant on fuser technology.

<sup>4</sup> Recovery time from Ready/Sleep to start of printing = 8.5 seconds.

<sup>5</sup> Maximum heat dissipation for all models in Ready mode = 45 BTU/hour

# Environmental specifications

**Table B-4 Environmental specifications<sup>1</sup>**

|                   | <b>Recommended</b>                 | <b>Operating</b>                   | <b>Storage</b>                   |
|-------------------|------------------------------------|------------------------------------|----------------------------------|
| Temperature       | 15° to 32.5° C<br>(59° to 90.5° F) | 15° to 32.5° C<br>(59° to 90.5° F) | -20° to 40° C<br>(-4° to 104° F) |
| Relative humidity | 10% to 80%                         | 10% to 80%                         | 95% or less                      |

<sup>1</sup> Values are subject to change.

# Acoustic emissions

**Table B-5 Acoustic emissions<sup>2</sup>**

| <b>Sound Power Level</b>                         | <b>Declared per ISO 9296<sup>1</sup></b> |
|--|--|
| Printing (26 ppm)                                | $L_{WA,d} = 6.4$ Bels (A) [64 dB (A)]    |
| Ready  | Inaudible                                |
| <b>Sound Pressure Level - Bystander Position</b> | <b>Declared per ISO 9296<sup>1</sup></b> |
| Printing (26 ppm)                                | $L_{pA,m} = 50$ dB(A)                    |
| Ready  | Inaudible                                |

<sup>1</sup> Values are based on preliminary data. See [www.hp.com/support/LJM2727](http://www.hp.com/support/LJM2727) for current information.

<sup>2</sup> Configuration tested: HP LaserJet M2727nf printing simplex using A4 paper at 26 ppm.



---

# C Regulatory information

This section contains the following regulatory information:

- [FCC compliance](#)
- [Environmental product stewardship program](#)
- [Telephone Consumer Protection Act \(United States\)](#)
- [IC CS-03 requirements](#)
- [EU statement for telecom operation](#)
- [New Zealand telecom statements](#)
- [Declaration of conformity](#)
- [Safety statements](#)

## FCC compliance

This equipment has been tested and found to comply with the limits for a Class B digital device, pursuant to Part 15 of the FCC rules. These limits are designed to provide reasonable protection against harmful interference in a residential installation. This equipment generates, uses, and can radiate radio frequency energy. If it is not installed and used in accordance with the instructions, it may cause harmful interference to radio communications. However, there is no guarantee that interference will not occur in a particular installation. If this equipment does cause harmful interference to radio or television reception, which can be determined by turning the equipment off and on, the user is encouraged to try to correct the interference by one or more of the following measures:

- Reorient or relocate the receiving antenna.
- Increase separation between equipment and receiver.
- Connect equipment to an outlet on a circuit different from that to which the receiver is located.
- Consult your dealer or an experienced radio/TV technician.

---

 **NOTE:** Any changes or modifications to the printer that are not expressly approved by Hewlett-Packard could void the user's authority to operate this equipment.

Use of a shielded interface cable is required to comply with the Class B limits of Part 15 of the FCC rules.

---

This equipment complies with FCC rules, Part 68. On the back of this equipment is a label that contains, among other information, the FCC registration number and ringer equivalence number (REN) for this equipment. If requested, this information must be provided to the telephone company. The REN is used to determine the quantity of devices that might be connected to the telephone line. Excessive RENs on the telephone line may result in the devices not ringing in response to an incoming call. In most, but not all, areas, the sum of the RENs should not exceed five (5.0). To be certain of the number of devices that might be connected to the line, as determined by the total RENs, contact the telephone company to determine the maximum REN for the calling area.

This equipment uses the following USOC jacks: RJ11C.

An FCC-compliant telephone cord and modular plug is provided with this equipment. This equipment is designed to be connected to the telephone network or premises wiring using a compatible modular jack that is Part 68 compliant. This equipment cannot be used on telephone company-provided coin service. Connection to Party Line Service is subject to state tariffs. If this equipment causes harm to the telephone network, the telephone company will notify you in advance that temporary discontinuance of service may be required. If advance notice is not practical, the telephone company will notify the customer as soon as possible. Also, you will be advised of your right to file a complaint with the FCC if you believe it is necessary. The telephone company may make changes in its facilities, equipment, operations, or procedures that could affect the operation of the equipment. If this happens, the telephone company will provide advance notice in order for you to make the necessary modifications in order to maintain uninterrupted service. If trouble is experienced with this equipment, please see the numbers in the front of this manual for repair and (or) warranty information. If the trouble is causing harm to the telephone network, the telephone company may request you remove the equipment from the network until the problem is resolved. The following repairs can be done by the customer: Replace any original equipment that came with the device. This includes the print cartridge, the supports for trays and bins, the power cord, and the telephone cord. It is recommended that the customer install an AC surge arrestor in the AC outlet to which this device is connected. This is to avoid damage to the equipment caused by local lightning strikes and other electrical surges.

# Environmental product stewardship program

## Protecting the environment

Hewlett-Packard Company is committed to providing quality products in an environmentally sound manner. This product has been designed with several attributes to minimize impacts on our environment.

## Ozone production

This product generates no appreciable ozone gas (O<sub>3</sub>).

## Power consumption

Power usage drops significantly while in Ready/Sleep mode, which saves natural resources and saves money without affecting the high performance of this product. To determine the ENERGY STAR® qualification status for this product see the Product Data Sheet or Specifications Sheet. Qualified products are also listed at:

<http://www.hp.com/hpinfo/globalcitizenship/environment/productdesign/ecolabels.html>

## Toner consumption

EconoMode uses less toner, which might extend the life of the print cartridge.

## Paper use

This device's manual/automatic duplex feature (two-sided printing) and N-up printing (multiple pages printed on one page) capability can reduce paper usage and the resulting demands on natural resources.

## Plastics

Plastic parts over 25 grams are marked according to international standards that enhance the ability to identify plastics for recycling purposes at the end of the product's life.

## HP LaserJet print supplies

It's easy to return and recycle your empty HP LaserJet print cartridges—free of charge—with HP Planet Partners. Multilingual program information and instructions are included in every new HP LaserJet print cartridge and supplies package. You help reduce the toll on the environment further when you return multiple cartridges together rather than separately.

HP is committed to providing inventive, high-quality products and services that are environmentally sound, from product design and manufacturing to distribution, customer use and recycling. When you participate in the HP Planet Partners program, we ensure your HP LaserJet print cartridges are recycled properly, processing them to recover plastics and metals for new products and diverting millions of tons of waste from landfills. Since this cartridge is being recycled and used in new materials, it will not be returned to you. Thank you for being environmentally responsible!

 **NOTE:** Use the return label to return original HP LaserJet print cartridges only. Please do not use this label for HP inkjet cartridges, non-HP cartridges, refilled or remanufactured cartridges or warranty returns. For information about recycling your HP inkjet cartridges please go to <http://www.hp.com/recycle>.

## Return and recycling instructions

### United States and Puerto Rico

The enclosed label in the HP LaserJet toner cartridge box is for the return and recycling of one or more HP LaserJet print cartridges after use. Please follow the applicable instructions below.

#### Multiple returns (two to eight cartridges)

1. Package each HP LaserJet print cartridge in its original box and bag.
2. Tape up to eight single boxes together using strapping or packaging tape (up to 70 lbs).
3. Use a single pre-paid shipping label.

#### OR

1. Use your own suitable box, or request a free bulk collection box from the <http://www.hp.com/recycle> or 1-800-340-2445 (holds up to eight HP LaserJet print cartridges).
2. Use a single pre-paid shipping label.

#### Single returns

1. Package the HP LaserJet print cartridge in its original bag and box.
2. Place the shipping label on the front of the box.

#### Shipping

For all HP LaserJet print cartridge recycling returns, give the package to UPS during your next delivery or pickup, or take it to an authorized UPS drop-off center. For the location of your local UPS drop-off center, call 1-800-PICKUPS or visit <http://www.ups.com>. If you are returning via USPS label, give the package to a U.S. Postal Service carrier or drop off at a U.S. Postal Service Office. For more information, or to order additional labels or boxes for bulk returns, visit <http://www.hp.com/recycle> or call 1-800-340-2445. Requested UPS pickup will be charged normal pickup rates. Information subject to change without notice.

#### Non-US returns

To participate in HP Planet Partners return and recycling program, just follow the simple directions in the recycling guide (found inside the packaging of your new printer supply item) or visit <http://www.hp.com/recycle>. Select your country/region for information on how to return your HP LaserJet printing supplies.

#### Paper

This product is capable of using recycled papers when the paper meets the guidelines outlined in the *HP LaserJet Printer Family Print Media Guide*. This product is suitable for the use of recycled paper according to EN12281:2002.

#### Material restrictions

This HP product does not contain added mercury.

This HP product contains a battery that might require special handling at end-of-life. The batteries contained in or supplied by Hewlett-Packard for this product include the following:



| HP LaserJet M2727 |                             |
|-------------------|-----------------------------|
| Type              | Carbon monofluoride lithium |
| Weight            | 0.8 g                       |
| Location          | On formatter board          |
| User-removable    | No                          |



## 廢電池請回收

For recycling information, you can go to [www.hp.com/recycle](http://www.hp.com/recycle), or contact your local authorities or the Electronics Industries Alliance: [www.eiae.org](http://www.eiae.org).

## Disposal of waste equipment by users in private households in the European Union

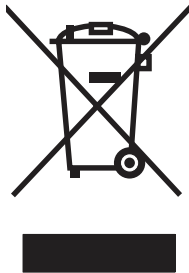

This symbol on the product or on its packaging indicates that this product must not be disposed of with your other household waste. Instead, it is your responsibility to dispose of your waste equipment by handing it over to a designated collection point for the recycling of waste electrical and electronic equipment. The separate collection and recycling of your waste equipment at the time of disposal will help to conserve natural resources and ensure that it is recycled in a manner that protects human health and the environment. For more information about where you can drop off your waste equipment for recycling, please contact your local city office, your household waste disposal service or the shop where you purchased the product.

## Material Safety Data Sheet (MSDS)

Material Safety Data Sheets (MSDS) for supplies containing chemical substances (for example, toner) can be obtained by contacting the HP Web site at [www.hp.com/go/msds](http://www.hp.com/go/msds) or [www.hp.com/hpinfo/globalcitizenship/environment](http://www.hp.com/hpinfo/globalcitizenship/environment).

## For more information

To obtain information about these environmental topics:

- Product environmental profile sheet for this and many related HP products
- HP's commitment to the environment
- HP's environmental management system
- HP's end-of-life product return and recycling program
- Material Safety Data Sheets

Visit [www.hp.com/go/environment](http://www.hp.com/go/environment) or [www.hp.com/hpinfo/globalcitizenship/environment/index.html](http://www.hp.com/hpinfo/globalcitizenship/environment/index.html).

## Telephone Consumer Protection Act (United States)

The Telephone Consumer Protection Act of 1991 makes it unlawful for any person to use a computer or other electronic device, including fax machines, to send any message unless such message clearly contains, in a margin at the top or bottom of each transmitted page or on the first page of the transmission, the date and time it is sent and an identification of the business, other entity, or individual sending the message and the telephone number of the sending machine or such business, other entity, or individual. (The telephone number provided cannot be a 900 number or any other number for which charges exceed local or long-distance transmission charges.)

### IC CS-03 requirements

**Notice:** The Industry Canada label identifies certified equipment. This certification means the equipment meets certain telecommunications network protective, operational, and safety requirements as prescribed in the appropriate Terminal Equipment Technical Requirement document(s). The Department does not guarantee the equipment will operate to the user's satisfaction. Before installing this equipment, users should ensure that it is permissible for the equipment to be connected to the facilities of the local telecommunications company. The equipment must also be installed using an acceptable method of connection. The customer should be aware that compliance with the above conditions may not prevent degradation of service in some situations. Repairs to certified equipment should be coordinated by a representative designated by the supplier. Any repairs or alterations made by the user to this equipment, or equipment malfunctions, may give the telecommunications company cause to request the user to disconnect the equipment. Users should ensure for their own protection that the electrical ground connections of the power utility, telephone lines, and internal metallic water pipe system, if present, are connected together. This precaution can be particularly important in rural areas.

---

**CAUTION:** Users should not attempt to make such connections themselves, but should contact the appropriate electric inspection authority, or electrician, as appropriate. The Ringer Equivalence Number (REN) of this device is 0.7.

---

**Notice:** The Ringer Equivalence Number (REN) assigned to each terminal device provides an indication of the maximum number of terminals allowed to be connected to a telephone interface. The termination on an interface may consist of any combination of devices subject only to the requirement that the sum of the Ringer Equivalence Number of all the devices does not exceed five (5.0). The standard connecting arrangement code (telephone jack type) for equipment with direct connections to the telephone network is CA11A.

## EU statement for telecom operation

This product is intended to be connected to the analog Public Switched Telecommunication Networks (PSTN) of European Economic Area (EEA) countries/regions. It meets requirements of EU R&TTE Directive 1999/5/EC (Annex II) and carries appropriate CE conformity marking. For more details, see Declaration of Conformity issued by the manufacturer in another section of this manual. However, due to differences between individual national PSTNs, the product may not guarantee unconditional assurance of successful operation on every PSTN termination point. Network compatibility depends on the correct setting being selected by the customer in preparation of its connection to the PSTN. Please follow the instructions provided in the user manual. If you experience network compatibility issues, please contact your equipment supplier or Hewlett-Packard help desk in the country/region of operation. Connecting to a PSTN termination point may be the subject of additional requirements set out by the local PSTN operator.

## New Zealand telecom statements

The grant of a Telepermit for any item of terminal equipment indicates only that Telecom has accepted that the item complies with minimum conditions for connection to its network. It indicates no endorsement of the product by Telecom, nor does it provide any sort of warranty. Above all, it provides no assurance that any item will work correctly in all respects with another item of Telepermitted equipment of a different make or model, nor does it imply that any product is compatible with all of Telecom's network services.

This equipment may not provide for the effective hand-over of a call to another device connected to the same line.

This equipment shall not be set up to make automatic calls to the Telecom "111" Emergency Service.

This product has not been tested to ensure compatibility with the FaxAbility distinctive ring service for New Zealand.

# Declaration of conformity

## Declaration of Conformity

according to ISO/IEC 17050-1 and EN 17050-1

**Manufacturer's Name:** Hewlett-Packard Company DoC#: BOISB-0602-01-rel.1.0  
**Manufacturer's Address:** 11311 Chinden Boulevard,  
Boise, Idaho 83714-1021, USA

**declares, that the product**

**Product Name:** HP LaserJet M2727 nf and M2727nfs  
**Regulatory Model Number<sup>2)</sup>** BOISB-0602-01

**Product Options:** Including: Q7556A—Optional 250-Sheet Input Tray  
**Print Cartridges:** ALL  
Q7553A / Q7553X

**conforms to the following Product Specifications:**

**SAFETY:** IEC 60950-1:2001 / EN60950-1: 2001 +A11  
IEC 60825-1:1993 +A1 +A2 / EN 60825-1:1994 +A1 +A2 (Class 1 Laser/LED Product)  
GB4943-2001

**EMC:** CISPR22:2005 / EN55022:2006 – Class B<sup>1)</sup>  
EN 61000-3-2:2000 +A2  
EN 61000-3-3:1995 +A1  
EN 55024:1998 +A1 +A2  
FCC Title 47 CFR, Part 15 Class B<sup>1)</sup> / ICES-003, Issue 4  
GB9254-1998, GB17625.1-2003

**TELECOM:** ES 203 021; FCC Title 47 CFR, Part 68<sup>3)</sup>

### Supplementary Information:

The product herewith complies with the requirements of the EMC Directive 2004/108/EC and the Low Voltage Directive 2006/95/EC, the R&TTE Directive 1999/5/EC (Annex II), and carries the CE-Marking accordingly.

This Device complies with Part 15 of the FCC Rules. Operation is subject to the following two Conditions: (1) this device may not cause harmful interference, and (2) this device must accept any interference received, including interference that may cause undesired operation.

- 1) The product was tested in a typical configuration with Hewlett-Packard Personal Computer Systems.
- 2) For regulatory purposes, this product is assigned a Regulatory model number. This number should not be confused with the product name or the product number(s).
- 3) Telecom approvals and standards appropriate for the target countries have been applied to this product, in addition to those listed above.

Boise, Idaho , USA

**July 2007**

### For regulatory topics only:

**European Contact:** Your Local Hewlett-Packard Sales and Service Office or Hewlett-Packard GmbH, Department HQ-TRE / Standards Europe,, Herrenberger Strasse 140, , D-71034, Böblingen, (FAX: +49-7031-14-3143)

**USA Contact:** Product Regulations Manager, Hewlett-Packard Company,, PO Box 15, Mail Stop 160, Boise, ID 83707-0015, , (Phone: 208-396-6000)

## Safety statements

### Laser safety

The Center for Devices and Radiological Health (CDRH) of the U.S. Food and Drug Administration has implemented regulations for laser products manufactured since August 1, 1976. Compliance is mandatory for products marketed in the United States. The device is certified as a “Class 1” laser product under the U.S. Department of Health and Human Services (DHHS) Radiation Performance Standard according to the Radiation Control for Health and Safety Act of 1968. Since radiation emitted inside the device is completely confined within protective housings and external covers, the laser beam cannot escape during any phase of normal user operation.

---

**WARNING!** Using controls, making adjustments, or performing procedures other than those specified in this user guide may result in exposure to hazardous radiation.

---

### Canadian DOC regulations

Complies with Canadian EMC Class B requirements.

« Conforme à la classe B des normes canadiennes de compatibilité électromagnétiques. « CEM ». »

### EMI statement (Korea)

**B급 기기 (가정용 정보통신기기)**

이 기기는 가정용으로 전자파적합등록을 한 기기로서  
주거지역에서는 물론 모든지역에서 사용할 수 있습니다.

## Laser statement for Finland

### **Luokan 1 laserlaite**

Klass 1 Laser Apparat

HP LaserJet M2727nf, M2727nfs, laserkirjoitin on käyttäjän kannalta turvallinen luokan 1 laserlaite. Normaalissa käytössä kirjoittimen suojakoteloointi estää lasersäteen pääsyn laitteen ulkopuolelle. Laitteen turvallisuusluokka on määritetty standardin EN 60825-1 (1994) mukaisesti.

### **VAROITUS !**

Laitteen käyttäminen muulla kuin käyttöohjeessa mainitulla tavalla saattaa altistaa käyttäjän turvallisuusluokan 1 ylittävälle näkymättömälle lasersäteilylle.

### **WARNING !**

Om apparaten används på annat sätt än i bruksanvisning specificerats, kan användaren utsättas för osynlig laserstrålning, som överskrider gränsen för laserklass 1.

### **HUOLTO**

HP LaserJet M2727nf, M2727nfs - kirjoittimen sisällä ei ole käyttäjän huollettavissa olevia kohteita. Laitteen saa avata ja huoltaa ainoastaan sen huoltamiseen koulutettu henkilö. Tällaiseksi huoltotoimenpiteeksi ei katsota väriainekasetin vaihtamista, paperiradan puhdistusta tai muita käyttäjän käsikirjassa lueteltuja, käyttäjän tehtäväksi tarkoitettuja ylläpitotoimia, jotka voidaan suorittaa ilman erikoistyökaluja.

### **VARO !**

Mikäli kirjoittimen suojakotelo avataan, olet alttiina näkymättömälle lasersäteilylle laitteen ollessa toiminnassa. Älä katso säteeseen.

### **WARNING !**

Om laserprinterns skyddshölje öppnas då apparaten är i funktion, utsättas användaren för osynlig laserstrålning. Betrakta ej strålen. Tiedot laitteessa käytettävän laserdiodin säteilyominaisuuksista: Aallonpituus 775-795 nm Teho 5 m W Luokan 3B laser.

## Substances table (China)

### 有毒有害物质表

根据中国电子信息产品污染控制管理办法的要求而出台

| 部件名称   | 有毒有害物质和元素 |           |           |                 |               |                 |
|--------|-----------|-----------|-----------|-----------------|---------------|-----------------|
|        | 铅<br>(Pb) | 汞<br>(Hg) | 镉<br>(Cd) | 六价铬<br>(Cr(VI)) | 多溴联苯<br>(PBB) | 多溴二苯醚<br>(PBDE) |
| 打印引擎   | X         | 0         | X         | X               | 0             | 0               |
| 复印机组件  | X         | 0         | 0         | 0               | 0             | 0               |
| 控制面板   | 0         | 0         | 0         | 0               | 0             | 0               |
| 塑料外壳   | 0         | 0         | 0         | 0               | 0             | 0               |
| 格式化板组件 | X         | 0         | 0         | 0               | 0             | 0               |
| 碳粉盒    | X         | 0         | 0         | 0               | 0             | 0               |
|        |           |           |           |                 |               |                 |

0: 表示在此部件所用的所有同类材料中, 所含的此有毒或有害物质均低于 SJ/T11363-2006 的限制要求。

X: 表示在此部件所用的所有同类材料中, 至少一种所含的此有毒或有害物质高于 SJ/T11363-2006 的限制要求。

注: 引用的“环保使用期限”是根据在正常温度和湿度条件下操作使用产品而确定的。



# Index

## Symbols/Numerics

250-sheet tray. See tray 2 or tray 3

## A

ac inlet cable

removing 126

stapler, removing 126

accessibility features 4

accessories, part numbers 248

acoustic emissions 325

activity log, fax

printing 239

troubleshooting 226

ADF

assembly, removing 115

cleaning pickup-roller

assembly 55

components 276

detection operations 75

diagrams 267

functions 73

install input tray 23

jam detection 75

jams 180

load originals 26

locating 5

operations 73

page sizes supported 222

paper path 74

part numbers 254, 272

pickup-roller assembly,

replacing 110

removing scanner

assembly 117

scanner assembly,

removing 117

scanner glass, removing 113

sensors 74

trailing edge detection 75

troubleshooting 229

ADF jam detection

document-feeder jam 75

long-document jam 75

stall jam 75

trailing edge detection 75

ADF paper path 74

ADF pickup-roller assembly

replacing 110

ADF scanner glass

removing 113

ADF sensors 74

after service checklist 96

alert messages 169

Alerts tab

HP ToolboxFX 59

answering machines,

troubleshooting 224

Apple Macintosh. See Macintosh

archive print setting 236, 242

assembly

ADF, removing 115

duplex, removing 135

duplexing, part numbers 302

duplexing-drive, part

numbers 298

engine controller,

removing 153

engine-controller 294

fuser, part numbers 304

interlock, removing 152

laser/scanner, removing 137

main gear, removing 162

main-drive 296

memory-tag-reader,

removing 139

pick-up roller, replacing 110

pickup-and-feed,

removing 160

pickup-roller, removing 110

registration-roller,

removing 161

scanner/ADF, removing 117

stapler, removing 122

automatic document feeder (ADF)

jams 180

locating 5

## B

background, gray 207

bands, troubleshooting 206

batteries included 330

battery specifications 36

bezels, control panel

part numbers 255

removing 119

billing (metering) tone filters 91

billing code report, fax 240

billing filters

fax 91

bins, output

jams, clearing 186

locating 5

blank copies,

troubleshooting 217

blank scans, troubleshooting 213

box, unpacking 22

## C

cables

flat flexible cables (FFCs) 137

part numbers 248

stapler, removing 126

call report, fax

printing 239

troubleshooting 226

Canadian DOC regulations 336

cartridge. See print cartridge

cartridge door components, part numbers 284

- cartridge-door release, locating 5
  - cartridges
    - alerts 59
    - drum rotation test 230
    - high-voltage contacts 233
    - HP fraud hotline 48
    - non-HP 48
    - part numbers 248
    - recycle 35
    - recycling 329
    - status page, printing 237
    - warranty 321
  - characters, troubleshooting 208
  - checklist
    - print-quality 205
  - checklists
    - after service 96
    - before service 95
    - preservice 95
    - troubleshooting 166
  - checks
    - drum rotation 230
    - engine 231
    - half-self-test 232
    - heating element 233
    - high-voltage power supply 233
  - circuit diagram (1 of 2) 268
  - circuit diagram (2 of 2) 269
  - classes, HP Technical Training 258
  - cleaning
    - ADF pickup-roller assembly 55
    - exterior of product 49
    - flatbed scanner glass 49
    - high-voltage connection points 234
    - high-voltage contacts 233
    - paper path 56
    - pickup roller 52
    - product 49
    - scanner-cover backing 51
    - tray 2 pickup roller 52
  - cleaning page 56
  - cleaning page, printing 241
  - cleaning paper path
    - control panel 57
    - HP ToolboxFX 57
  - clearing
    - ADF, jams 180
    - duplexer 184
    - input-tray areas 182
    - output-bin areas 186
    - print-cartridge areas 188
    - stapler 189
  - clearing jams
    - ADF 180
  - CO operations 87
  - comparing
    - features 3
  - component diagrams
    - major 266
  - computer
    - security features 87
  - Configuration page 237
  - connectors
    - fax card 261
    - formatter 260
  - control panel
    - bezel part numbers 255
    - bezel, removing 119
    - button description 7
    - cleaning paper path 57
    - display, troubleshooting 227
    - faceplate, install 25
    - menus 191
    - menus, access 191
    - messages, troubleshooting 169
    - removing 119
    - secondary menu 199
    - Service menu 241
    - service menu 235
  - controls
    - hook switch control 90
  - convenience stapler
    - jams, clearing 189
    - specifications 4
  - copy
    - tray selection 29
  - copy quality
    - test 96
  - copy setup menu 192
  - copy-quality test 96
  - copying
    - media, troubleshooting 215
    - quality, troubleshooting 214
    - setup menu 192
    - size, troubleshooting 217
    - troubleshooting 214, 217
  - covers
    - left, removing 102
    - part numbers 282
    - rear, removing 106
    - right, removing 100
    - top, removing 108
  - creases, troubleshooting 209
  - crooked pages 209
  - curled media 209, 236
  - current control, fax line 91
  - Customer Care Online 258
- D**
- dark copies 215
  - data path
    - fax 90
  - dc controller 78
  - defaults, restoring 236, 241
  - defects, repetitive 259
  - Demo page, printing 238
  - Developer's menu 201
  - device detection, downstream fax 90
  - device information page
    - HP ToolboxFX 63
  - device polling
    - HP ToolboxFX 65
  - diagrams
    - troubleshooting 259
  - dialing
    - fax 195
    - troubleshooting 222
  - dialing, pulse 90
  - digital subscriber line (DSL), troubleshooting 228
  - dimensions
    - media 16
  - DIMM door, locating 6
  - DIMMs
    - adding 30
    - installing 30
    - part numbers 248
  - Director, Macintosh 13
  - display, troubleshooting control panel 227
  - disposal, end-of-life 330
  - distinctive ring 88

- documentation
    - getting started guide,
    - languages 258
    - user guide, languages 257
    - Web sites, technical support 258
  - door
    - print-cartridge door,
    - removing 104
  - dots per inch (dpi)
    - print settings 204
    - specifications 4
  - dots, troubleshooting 206
  - downstream device detection
    - fax 90
  - dpi (dots per inch)
    - faxing 195
    - print settings 204
    - specifications 4
  - drivers
    - specifications 4
    - supported 9
  - drum rotation test 230
  - DSL, troubleshooting 228
  - duplex assembly, removing 135
  - duplex solenoid, removing 145
  - duplex-drive gears, removing 143
  - duplexer
    - jams, clearing 184
  - duplexing assembly, part numbers 302
  - duplexing-drive assembly, part numbers 298
- E**
- e-label reader 139
  - e-mail alerts 59
  - electrical specifications 324
  - electrostatic discharge (ESD) 94
  - embedded Web server (EWS)
    - browsers supported 12
    - features 66
    - setting password 67
  - end-of-life disposal 330
  - engine control system 78
  - engine controller assembly (ECU), removing 153
  - engine test 231
  - engine-controller assembly (ECU), part numbers 294
  - environmental specifications 20, 325
  - environmental stewardship program 329
  - error messages
    - ADF paper jams 75
    - paper jams, ADF 75
  - error messages
    - control panel 169
    - critical 177
  - ESD (electrostatic discharge) 94
  - EU statement for telecom operation 334
  - European Union, waste disposal 331
  - Event log
    - HP ToolboxFX 59
  - express software installation
    - included components list 10
- F**
- faceplate, install control panel 25
  - factory-set defaults, restoring 236, 241
  - faded print 206
  - fan, removing 141
  - fax
    - activity log 239
    - answer mode 196
    - billing (metering) tone filters 91
    - billing code report, printing 240
    - cables, part numbers 248
    - call report, printing 239
    - checklist, troubleshooting 218
    - data path 90
    - distinctive ring 88
    - downstream current detection 90
    - error messages 172
    - factory-set defaults, restoring 241
    - fax card 89
    - fax pages, storage 91
    - fax subsystem 89
    - fax-quality test 97
    - flash memory storage 91
    - functions 87
    - hook state 90
    - hook switch control 90
    - jams, troubleshooting 179, 225
    - line current control 91
    - operations 87
    - operations, PSTN 87
    - page storage 91
    - performance, troubleshooting 226
    - phone book 60
    - phone book, printing 239
    - PSTN operations 87
    - pulse dialing 90
    - receive log 62
    - receiving 87
    - receiving, troubleshooting 219
    - report, printing 239
    - reports 193
    - reports, troubleshooting 226
    - ring detect 91
    - ring type 196
    - safety isolation 89
    - safety protection circuitry 89
    - security features, computer 87
    - security features, network 87
    - send log, HP ToolboxFX 62
    - sending, troubleshooting 222
    - stored fax pages 91
    - T.30 protocol trace report 242
    - test, fax quality 97
    - troubleshooting 218
    - voice-call, troubleshooting 224
  - fax card
    - CODEC 89
    - connectors 261
    - DSP 89
    - fax subsystem 89
    - hook switch control 90
    - part numbers 280
    - pulse dialing 90
    - regional versions 89
    - ring detect 91
    - safety isolation 89
    - safety-protection circuitry 89
  - fax functions menu 191
  - fax job status menu 191
  - fax page storage 91
  - fax ports, locating 6

- fax reports, printing 193
  - fax send log
    - HP ToolboxFX 62
  - fax setup menu 194
  - fax subsystem
    - fax card 89
  - Fax tab
    - HP ToolboxFX 59
  - fax tab, HP ToolboxFX
    - fax receive log 62
    - fax send log 62
    - log, fax receive 62
    - log, fax send 62
  - fax, performance 226
  - fax-quality test 97
  - faxing
    - voice over IP (VoIP) services 88
  - FCC compliance 328
  - features
    - product 4
  - feed system, ADF 73
  - field replaceable units (FRUs)
    - removing 93
    - replacing 93
  - Finnish laser safety statement 337
  - firmware updates 243
  - flash memory, fax 91
  - flat flexible cables (FFCs) 137
  - flatbed scanner
    - cleaning glass 49
    - load originals 26
  - font list 237
  - formatter
    - connectors 260
    - part numbers 280
    - removing 132
  - fraud hotline 48
  - fuser
    - error 177
    - warranty 321
  - fuser assembly, part number 304
  - fuser, removing 147
- G**
- gears
    - duplex-drive, removing 143
  - Getting Started Guide 2, 258
  - glass, cleaning 49
  - gray background,
    - troubleshooting 207
  - guides. See documentation
- H**
- half-self-test functional check 232
  - heating element check 233
  - Help (Documentation) tab
    - HP ToolboxFX 62
  - high-voltage PCA 78
  - high-voltage power supply,
    - checking 233
  - hook state
    - fax 90
  - hook switch control 90
  - HP Customer Care Online 258
  - HP Director, Macintosh 13
  - HP fraud hotline 48
  - HP jewel, part number 280
  - HP Printing Supplies Returns 35
  - HP Recycling Program 35
  - HP Technical Training 258
  - HP ToolboxFX
    - Alerts tab 59
    - cleaning paper path 57
    - device information page 63
    - device polling 65
    - Event log 59
    - factory-set defaults,
      - restoring 241
    - fax phone book 60
    - Fax tab 59
    - features 58
    - Help (Documentation) tab 62
    - managing product 58
    - Network Settings tab 66
    - paper handling page 64
    - Paper Types settings 64
    - PCL 5e, print driver
      - settings 66
    - PostScript, print driver
      - settings 66
    - print driver settings, PCL
      - 5e 66
    - print driver settings,
      - PostScript 66
    - Print Quality settings 64
    - Print Settings tab 65
    - Printing tab 65
  - Service tab 65
  - status alerts 59
  - Status tab 58
  - system requirements 58
  - System Settings tab 63
  - system setup 65
  - Troubleshooting tab 240
  - viewing 58
- HP ToolboxFX, fax tab
  - fax receive log 62
  - log, fax receive 62
  - log, fax send 62
  - send log 62
- humidity specifications
  - environment 325
- I**
- IC CS-03 requirements 333
  - image quality
    - archive print setting 236, 242
    - cleaning page, printing 241
    - copy, troubleshooting 214
    - HP ToolboxFX settings 64
    - print, troubleshooting 204, 205
    - repetitive image defects 259
    - scans, troubleshooting 211, 213
  - image-formation system
    - operations 83
    - testing 232
  - importing
    - fax phone book, HP
      - ToolboxFX 60
    - HP ToolboxFX, fax phone
      - book 60
  - information pages
    - Configuration 237
    - Demo 238
    - menu map 237, 238
    - Supplies Status 237
    - T.30 protocol trace report 242
    - usage 238
  - ink cartridges. See print cartridges
  - input tray
    - load media 28
  - input trays. See trays
  - input-tray areas
    - jams, clearing 182

- install
  - ADF input tray 23
  - control-panel faceplate 25
  - tray 3 24
- installation, software
  - included components list, express 9
  - included components list, recommended 9
- installing
  - control-panel faceplate 25
  - DIMMs 30
  - memory, DIMMs 30
- interface ports
  - cables, ordering 248
  - locating 6, 260
  - types included 4
- interlock assembly, removing 152
- internal assembly
  - removing 122
  - replacing 122
- internal components 76
- internal components, part numbers 286

## J

- jam detection
  - ADF 75
  - trailing edge detection, ADF 75
- jams
  - ADF, clearing 180
  - alerts 59
  - causes of 179
  - duplexer, clearing 184
  - fax 225
  - fax, clearing 180
  - locating 180
  - output-bin, clearing 186
  - preventing 190
  - print cartridge area, clearing 188
  - stapler, clearing 189
  - trays, clearing 182
- jewel, part number 280

## K

- Korean EMI statement 336

## L

- languages, documentation 257

- laser safety statements 336, 337
- laser/scanner
  - removing 137
- laser/scanner system
  - operations 80
- left cover, removing 102
- life expectancies, supplies 34
- light copies 215
- light print, troubleshooting 206
- line current control, fax 91
- lines, troubleshooting
  - copies 215
  - printed pages 206
  - scans 213
- load
  - originals on flatbed scanner or ADF 26
- load media
  - optional tray 3 28
  - tray 1 27
  - tray 2 28
- loading
  - media 26
  - paper 26
  - stapler cassette 39
  - staples 39
- localized user guides 257
- locating
  - automatic document feeder (ADF) 5
  - bins 5
  - cartridge-door release 5
  - control panel 5
  - DIMM door 5
  - interface ports 5
  - internal components 76
  - jams, paper/media 180
  - power connector 5
  - power switch 5
  - print cartridge 5
  - print-cartridge door latch 5
  - rear output door 5
  - stapler 5
  - trays 5
- logs, fax
  - activity 239
  - billing codes 240
  - call (last fax sent or received) 239

- phone book 239
- troubleshooting 226
- loose toner, troubleshooting 208

## M

- Macintosh
  - drivers supported 9
  - Intel Core Processor 9
  - Macintosh Configure Device 13
  - PDEs 14
  - PPC 9
  - software components 13
  - system requirements 21
  - uninstall software 15
- Macintosh Configure Device
  - viewing 13, 67
- main gear assembly, removing 162
- main motor, removing 158
- main-drive assembly, part numbers 296
- major component diagrams 266
- managing product
  - HP ToolboxFX 58
- manuals. See documentation
- material restrictions 330
- Material Safety Data Sheet (MSDS) 331
- media
  - ADF feeding operations 73
  - ADF, sizes supported 222
  - curled, troubleshooting 209, 236
  - default size for tray 29
  - feeding operations 81
  - HP ToolboxFX settings 64
  - jams 179
  - loading 26
  - pickup/feed/delivery system 81
  - specifications 16
  - supported sizes 16
  - types to avoid 17
  - wrinkled 209
  - See also paper
- media jams
  - ADF, clearing 180
  - clearing 179
  - See also jams

- media types
  - HP ToolboxFX settings 64
- memory
  - error messages 171
  - flash, fax 91
  - installing 30
  - NVRAM initialization 235
  - part numbers 248
- memory, DIMMs
  - installing 30
- memory-tag-reader assembly,
  - removing 139
- menu
  - control panel, access 191
  - Copy setup 192
  - Developer's 201
  - Fax functions 191
  - Fax Job status 191
  - Fax setup 194
  - Reports 193
  - secondary service 200
  - Service 199
  - System setup 197
- menu (secondary)
  - control panel, access 199
- menu map, printing 238
- menus
  - control panel 191
  - Service 241
  - service 235
- mercury specifications 36
- mercury-free product 330
- messages
  - control panel 169
  - critical 177
- Microsoft Windows
  - drivers supported 9
- model number, locating 8
- moisture on the trailing edge,
  - troubleshooting 210
- motor, removing main 158
- multipurpose tray. *See* tray 2

**N**

- nameplate, part numbers 280
- network
  - device polling, HP Toolbox FX 65
  - DSL, troubleshooting 228

- HP ToolboxFX, device
  - polling 65
  - security features 87
- network port
  - locating 6
- network report 238
- Network Settings tab
  - HP ToolboxFX 66
- New Zealand telecom
  - statements 334
- noise specifications 325
- non-HP print cartridges 48
- non-HP supplies
  - HP policy 48

**O**

- off-hook 90
- on-hook 90
- on/off switch, locating 5
- Online Customer Care, HP 258
- operating environment,
  - specifications 20, 325
- operating systems, supported 9
- operation sequence 70
- operations
  - ADF 73
  - engine control system 78
  - fax, PSTN 87
  - image-formation system 83
  - laser/scanner system 80
  - pickup/feed/delivery system 81
  - PSTN 87
- optical system operations 72
- options. *See* settings
- order supplies 34
- ordering supplies and
  - accessories 247, 248
- output bins
  - locating 5
- output quality
  - archive print setting 236, 242
  - cleaning page, printing 241
  - copy, troubleshooting 214
  - HP ToolboxFX settings 64
  - print, troubleshooting 204, 205
  - repetitive image defects 259
  - scans, troubleshooting 211, 213

**P**

- PABX lines, troubleshooting 228
- pages
  - skewed 209
- paper
  - ADF feeding operations 73
  - ADF, sizes supported 222
  - curled, troubleshooting 209, 236
  - feeding operations 81
  - HP ToolboxFX settings 64
  - jams 179
  - loading 26
  - pickup/feed/delivery system 81
  - specifications 16
  - supported sizes 16
  - types to avoid 17
  - wrinkled 209
  - See also* media
- paper handling page
  - HP ToolboxFX 64
- paper jams
  - ADF detection operations 75
  - ADF, clearing 180
  - clearing 179
  - detection operations, pickup/feed/delivery system 81
  - error messages, ADF 75
  - locating 180
  - trailing edge detection, ADF 75
  - See also* jams
- paper path
  - ADF 74
  - ADF feeding operations 74
  - cleaning 56
- paper path, cleaning 241
- paper types
  - HP ToolboxFX settings 64
- part numbers
  - ADF 272
  - cables 248
  - cartridge door
    - components 284
  - control-panel bezels 255
  - covers 282
  - duplexing assembly 302
  - duplexing-drive assembly 298



- engine-controller
  - assembly 294
- fax card 280
- formatter 280
- fuser assembly 304
- internal components 286
- jewel 280
- main-drive assembly 296
- memory 248
- nameplate 280
- scanner 272
- screws 271
- stapler 278
- supplies 248
- trays 249, 300
- user guides 257
- parts
  - 245
  - field replaceable units (FRUs) 93
  - internal assemblies 122
  - ordering 247
  - removal-order list 98
  - removing 93
  - replacing 93
  - user-replaceable 94
- PCAs, diagrams 265
- PCL 5e print drivers
  - HP ToolboxFX settings 66
- PCL, PCL6, PS font list 237
- PDEs, Macintosh 14
- performance
  - troubleshooting 217
- phone book
  - fax tab, HP ToolboxFX 60
  - HP ToolboxFX, fax tab 60
- phone book, fax
  - HP ToolboxFX 60
  - printing 239
- phone numbers
  - HP fraud hotline 48
  - HP Printing Supplies Returns and Recycling Program 36
- photosensitive drum rotation test 230
- physical specifications 324
- pickup and feed system
  - ADF 73
- pickup rollers
  - ADF assembly, replacing 110
  - cleaning 52
  - cleaning ADF 55
  - diagrams 264
  - replacing, tray 2 40
- pickup solenoid (tray 2), removing 162
- pickup-and-feed assemblies
  - removing 160
- pickup-roller assembly, ADF
  - replacing 110
- pickup/feed/delivery system
  - operations 81
- pliers, required 95
- ports
  - cables, ordering 248
  - locating 6, 260
  - types included 4
- post-service tests 96
- PostScript print drivers
  - HP ToolboxFX settings 66
- power
  - high-voltage PCA 78
  - requirements 324
  - sequence of operations 71
  - testing high-voltage 233
- power connector, locating 6
- power consumption 324
- power cords, part numbers 248
- power supplies
  - fax line current control 91
- power supply
  - high-voltage contacts
    - check 233
  - stapler, removing 124
  - stapler, removing bracket and strap 127
- power switch, locating 5
- power-switch PCA, removing 130
- preservice checklist 95
- print cartridge area jams, clearing 188
- print cartridges
  - alerts 59
  - door release, locating 5
  - drum rotation test 230
  - high-voltage contacts 233
  - HP fraud hotline 48
  - non-HP 48
  - part numbers 248
  - recycle 35
  - recycling 329
  - removing 99
  - replacing 37
  - status page, printing 237
  - warranty 321
- print defects
  - troubleshooting 205
- print driver
  - included components list 9
  - included components list, Macintosh 10
- print drivers
  - supported 9
- print drivers, PCL 5e
  - HP ToolboxFX settings 66
- print drivers, PostScript
  - HP ToolboxFX settings 66
- print engine
  - laser/scanner assembly, removing 137
  - removing laser/scanner assembly 137
- print media
  - supported 16
- print quality
  - archive print setting 236, 242
  - checklist 205
  - cleaning page, printing 241
  - HP ToolboxFX settings 64
  - repetitive image defects 259
  - settings 204
  - test 96
  - troubleshooting 204, 205
- Print Settings tab
  - HP ToolboxFX 65
- print-cartridge door
  - removing 104
- print-quality checklist 205
- print-quality setting, 600 dpi 204
- print-quality test 96
- printer drivers
  - specifications 4
- printing
  - change tray selection 29
  - cleaning page 56
  - fax report 239
  - loading media 26
  - loading paper 26
  - menu map 237, 238
  - network report 238

Printing tab  
 HP ToolboxFX 65  
 priority input slot. See tray 1  
 problem solving. See troubleshooting  
 product  
 ADF functions 72  
 back view description 6  
 basic operation 70  
 cleaning 49  
 electrostatic discharge (ESD) 94  
 embedded Web server (EWS) features 66  
 fax, functions 87  
 features 4  
 front view description 5  
 image-formation system 83  
 information pages 237  
 internal components 76  
 managing 58  
 model number, locating 8  
 operation sequence 70  
 pages per minute (ppm) 4  
 performance 4  
 scanner functions 72  
 sequence of operations 70  
 serial number, locating 8  
 specifications 4, 323  
 supplies, life expectancies 34  
 supplies, managing 34  
 unpacking 22  
 user-replaceable parts 94  
 product information pages 237  
 PSTN operations 87  
 pulse dialing 90

## Q

quality  
 archive print setting 236, 242  
 cleaning page, printing 241  
 copy, troubleshooting 214  
 print settings 204  
 print, troubleshooting 204, 205  
 repetitive image defects 259  
 scans, troubleshooting 211, 213

## R

rear cover, removing 106  
 rear output bin, locating 6  
 receiving  
 fax 87  
 receiving faxes  
 activity log, printing 239  
 call report, printing 239  
 distinctive ring 88  
 log, HP ToolboxFX 62  
 T.30 protocol trace report 242  
 troubleshooting 219  
 recommended software installation included components list 10  
 recycle supplies  
 Web sites 35  
 recycling  
 battery 36  
 HP printing supplies returns and environmental program 330  
 mercury 36  
 restrictions 36  
 refilled print cartridges 48  
 regional versions  
 fax card 89  
 registration-roller assembly, removing 161  
 regulatory information 328  
 removing  
 ac inlet cable, stapler 126  
 ADF assembly 115  
 ADF pickup-roller assembly 110  
 ADF scanner glass 113  
 assembly, ADF 115  
 assembly, internal 122  
 bezel, control panel 119  
 bracket and strap, stapler 127  
 control panel, bezel 119  
 covers 100  
 doors 100  
 duplex assembly 135  
 duplex solenoid 145  
 duplex-drive gears 143  
 engine controller assembly 153  
 external parts 100  
 fan 141  
 formatter 132  
 fuser 147

interlock assembly 152  
 internal assembly 122  
 laser/scanner 137  
 main gear assembly 162  
 main motor 158  
 memory-tag-reader assembly 139  
 order of parts 98  
 panels 100  
 parts 93  
 parts, order 98  
 pickup solenoid (tray 2) 162  
 pickup-and-feed assemblies 160  
 pickup-roller assembly, ADF 110  
 power-switch PCA 130  
 registration-roller assembly 161  
 scanner assembly 117  
 scanner glass, ADF 113  
 screws 94  
 speaker 128  
 stapler ac inlet cable 126  
 stapler assembly 122  
 stapler bracket and strap 127  
 transfer roller 160  
 removing parts  
 ADF assembly 115  
 ADF pickup-roller assembly 110  
 ADF scanner glass 113  
 assembly, internal 122  
 bezel, control panel 119  
 cautions for 94  
 checklists 95  
 control panel, bezel 119  
 duplex assembly 135  
 duplex solenoid 145  
 duplex-drive gears 143  
 engine controller assembly 153  
 fan 141  
 formatter 132  
 fuser 147  
 interlock assembly 152  
 internal assembly 122  
 laser/scanner 137  
 main gear assembly 162  
 main motor 158



- memory-tag-reader
    - assembly 139
  - order 98
  - pickup-and-feed
    - assemblies 160
  - pickup-roller assembly,
    - ADF 110
  - power supply, stapler 124
  - power-switch PCA 130
  - print cartridges 99
  - print-cartridge door 104
  - registration-roller
    - assembly 161
  - scanner assembly 117
  - scanner glass, ADF 113
  - speaker 128
  - stapler ac inlet cable 126
  - stapler assembly 122
  - stapler power supply 124
  - stapler power supply bracket
    - and strap 127
  - tools, required 95
  - transfer roller 160
  - repair. *See* service
  - repetitive defects,
    - troubleshooting 210, 259
  - replace
    - supplies, life expectancies 34
  - replacing
    - ADF pickup-roller
      - assembly 110
    - ADF scanner glass 113
    - assemblies, internal 122
    - internal assemblies 122
    - pads, separation 45
    - parts 93
    - pickup roller, tray 2 40
    - pickup-roller assembly,
      - ADF 110
    - roller, pickup 40
    - scanner glass, ADF 113
    - screws 94
    - separation pads 45
    - tray 2 pickup roller 40
  - replacing parts
    - ADF pickup-roller
      - assembly 110
    - assemblies, internal 122
  - internal assemblies 122
    - pickup-roller assembly,
      - ADF 110
  - replacing print cartridges 37
  - report, product
    - fax 239
    - network 238
  - reports
    - configuration page 194
    - demo page 193
    - fax 193
    - menu map 193
    - network report 194
    - PCL 6 font list 194
    - PCL font list 194
    - PS font list 194
    - service page 194
    - supplies status page 194
    - usage page 194
  - reports menu 193
  - reports, fax
    - activity log 239
    - billing codes 240
    - call (last fax sent or received) 239
    - phone book 239
    - troubleshooting 226
  - reports, product
    - Configuration page 237
    - Demo page 238
    - Supplies Status page 237
    - T.30 protocol trace 242
  - required tools
    - user-replaceable parts 95
  - requirements
    - system 21
  - resolution
    - print settings 204
    - specifications 4
  - restoring factory-set defaults 236, 241
  - right cover, removing 100
  - ring detect
    - fax card 91
  - RING operations 87
  - rollers
    - ADF pickup assembly,
      - replacing 110
    - cleaning ADF pickup 55
    - cleaning tray 2 pickup 52
  - diagrams 264
    - locating 76
    - repetitive image defects 259
    - replace tray 2 pickup 40
    - transfer, removing 160
- S**
- safety isolation
    - fax 89
  - safety statements 336, 337
  - safety-protection circuitry
    - fax 89
  - scanner
    - assembly, removing 117
    - cleaning glass 49
    - cleaning scanner-cover
      - backing 51
    - components 274
    - diagrams 267
    - functions 72
    - load originals 26
    - optical system operations 72
    - part numbers 254, 272
    - removing assembly 117
  - scanner-cover backing,
    - cleaning 51
  - scanning
    - blank pages,
      - troubleshooting 213
    - quality, troubleshooting 211, 213
    - speed, troubleshooting 212
    - troubleshooting 211
  - scatter, troubleshooting 210
  - schedules, HP Technical Training 258
  - screwdrivers, required 95
  - screws
    - removing 94
    - replacing 94
    - types of 271
  - secondary service menu 200
  - security features
    - computer 87
    - network 87
  - sending faxes
    - activity log, printing 239
    - call report, printing 239
    - log, HP ToolboxFX 62

- T.30 protocol trace report 242
- troubleshooting 222
- sensors
  - ADF 74, 75
  - form sensor, ADF 75
  - locating 263
  - media detection 81
  - paper-present sensor, ADF 75
  - trailing edge detection, ADF 75
- separation pads
  - diagrams 264
  - replacing 45
- sequence of operations 70
- serial number, locating 8
- service
  - after-service check list 96
  - before service checklist 95
  - checklist, after service 96
  - checklist, before service 95
  - checklist, post-service 96
  - checklist, preservice 95
  - critical error messages 177
  - HP ToolboxFX settings 65
  - part numbers 248
  - post-service checklist 96
  - preservice checklist 95
  - tools, required 95
- Service menu 199, 241
- service menu 235
- service tab
  - HP ToolboxFX 65
- settings
  - Configuration page 237
  - factory-set defaults, restoring 236, 241
  - NVRAM initialization 235
- size 324
- skewed pages 209
- slow speed, troubleshooting
  - faxing 226
  - scanning 212
- smearred toner, troubleshooting 207
- software
  - components 9
  - drivers supported 9
  - HP ToolboxFX 58
  - Macintosh 13
  - Macintosh Configure Device 67
  - supported operating systems 9
  - system requirements 21
  - uninstall 15
  - Windows 12
- software installation
  - included components list, express 9
  - included components list, recommended 9
- solenoid
  - duplex, removing 145
  - pickup (tray 2), removing 162
- solenoids 262
- speaker, removing 128
- specifications
  - acoustic emissions 325
  - electrical 324
  - environmental 325
  - media 16
  - paper 16
  - physical 324
  - product features 4
- specks, troubleshooting 206
- speed
  - fax, troubleshooting 226
  - scanning, troubleshooting 212
- spots, troubleshooting 206
- staple cassette
  - life expectancy 34
  - loading 39
  - part number 248
  - specifications 4
- stapler
  - ac inlet cable, removing 126
  - assembly, removing 122
  - jams, clearing 189
  - loading staples 39
  - locating 5
  - part numbers 278
  - power supply bracket and strap, removing 127
  - power supply, removing 124
  - removing stapler assembly 122
  - staples, loading 39
  - troubleshooting 227
- stapler ac inlet cable
  - removing 126
- stapler power supply
  - bracket and strap, removing 127
  - removing 124
- staples, loading 39
- static precautions 94
- status
  - fax job 191
  - Supplies Status page, printing 237
- status alerts
  - HP ToolboxFX 59
- Status tab
  - HP ToolboxFX 58
- stored fax pages 91
- storing
  - environmental specifications 325
  - fax pages in flash memory 91
  - supplies 35
- strategy
  - parts, removal 94
  - parts, replacement 94
- streaks, troubleshooting 206
- supplies
  - alerts 59
  - HP fraud hotline 48
  - life expectancies 34
  - managing 34
  - non-HP 48
  - non-HP supplies policy 48
  - order 34
  - ordering 247
  - print cartridge, replacing 37
  - print cartridge, storage 35
  - recycling 35, 329
  - replacing print cartridges 37
  - status page 237
  - storage 35
  - support, technical 258
- supported
  - drivers 9
  - operating systems 9
  - print drivers 9
- supported media 16
- switches 263
- system requirements 21

- System Settings tab
  - HP ToolboxFX 63
- system setup
  - HP ToolboxFX settings 65
- System setup menu 197
- T**
- T.30 protocol trace report 242
- technical support 258
- Technical Training 258
- Telephone Consumer Protection Act 333
- telephone numbers
  - HP fraud hotline 48
  - HP Printing Supplies Returns and Recycling Program 36
- temperature specifications
  - environment 325
- tests
  - copy-quality 96
  - drum rotation 230
  - engine 231
  - fax-quality 97
  - half-self functional check 232
  - heating element 233
  - high-voltage power supply 233
  - post-service 96
  - print-quality 96
- text, troubleshooting 208
- TIP operations 87
- toner
  - cleaning page, printing 241
  - loose, troubleshooting 208
  - scatter, troubleshooting 210
  - smear, troubleshooting 207
  - specks, troubleshooting 206
- toner cartridges. *See* print cartridges
- tools, required
  - user-replaceable parts 95
- top cover, removing 108
- trailing edge detection
  - ADF 75
- Training, HP Technical 258
- transfer roller, removing 160
- transfer unit warranty 321
- tray 1
  - jams, clearing 182
  - load 27
- locating 5
- solenoids 262
- tray 2
  - cleaning pickup roller 52
  - jams, clearing 182
  - load 28
  - locating 5
  - part numbers 300
  - pickup solenoid, removing 162
  - replacing pickup roller 40
  - replacing separation pad 45
  - separation pad, replace 45
  - solenoids 262
- tray 3
  - install 24
  - jams, clearing 182
  - load 28
  - locating 5
  - part number 249
  - part numbers 254, 300
  - replacing separation pad 45
  - separation pad, replace 45
- trays
  - alerts 59
  - copy, changing selection 29
  - default media size 29
  - feeding operations 81
  - install ADF input 23
  - jams, clearing 182
  - locating 5
  - part numbers 249
  - pickup/feed/delivery system 81
- troubleshooting
  - ADF 229
  - blank scans 213
  - checklist 166
  - checklist, fax 218
  - cleaning page 241
  - control panel display 227
  - control panel messages 169
  - copy quality 214
  - copy size 217
  - copying 214, 217
  - critical error messages 177
  - curled media 209, 236
  - diagrams 259
  - dialing 222
  - drum rotation test 230
- DSL 228
- engine test 231
- faded print 206
- fax 218
- fax jams 225
- fax reports 226
- half self-test 232
- heating element 233
- image formation 232
- image quality 204
- jams 179
- lines, copies 215
- lines, printed pages 206
- lines, scans 213
- loose toner 208
- media-handling 215
- moisture on the trailing edge 210
- NVRAM initialization 235
- output quality 204
- PABX lines 228
- paper jams, clearing 179
- performance 217
- print defects 205
- print quality 204
- product information pages and reports 237
- receiving faxes 219
- repetitive defects 210
- scan quality 211, 213
- scanned image 211
- scanning 211
- sending faxes 222
- skewed pages 209
- speed, faxing 226
- staple jams 189
- stapler 227
- T.30 protocol trace report 242
- text 208
- toner scatter 210
- toner smear 207
- toner specks 206
- voice-call 224
- wrinkles 209
- Troubleshooting tab, HP ToolboxFX 240
- U**
- Uninstall software
  - Macintosh 15

- uninstall software
  - Add or Remove Programs 15
  - Windows 15
- unpack the product 22
- updating firmware 243
- usage page, printing 238
- USB port
  - locating 6
  - types included 4
- User Guide 2
- User guide
  - part numbers 257
- user-replaceable parts
  - required tools 95
  - tools required 95

- white or faded stripes 214
- Windows
  - software components 12
  - system requirements 21
  - uninstall software 15
- wrinkles, troubleshooting 209

## V

- vertical lines,
  - troubleshooting 206
- vertical white or faded stripes 214
- viewing
  - HP ToolboxFX 58
  - Macintosh Configure Device 67
- voice over IP (VoIP) services 88
- voice-call
  - troubleshooting 224
- voltage requirements 324
- volume
  - settings 198

## W

- warning messages 169
- warranty
  - print cartridge 321
  - product 319
  - transfer unit and fuser 321
- wavy paper, troubleshooting 209
- Web sites
  - HP Printing Supplies Returns and Recycling [www.hp.com/go/recycleProgram](http://www.hp.com/go/recycleProgram) 36
  - Material Safety Data Sheet (MSDS) 331
  - order supplies 34
  - ordering supplies 247
  - recycle supplies 35
  - technical support 258
- weight 324





CB532-90946